



**SURGICAL  
INSTRUMENTS**

- 10** Diagnostic Instruments
- 11** Puncture Instruments
- 12** Anaesthesia Instruments
- 13** General Instruments
- 14** General Instruments
- 15** General Instruments
- 16** General Instruments
- 17** General Instruments
- 18** General Instruments
- 19** Suture Instruments
- 20** Plaster Instruments
- 21** Bone Instruments
- 22** Tracheotomy Instruments
- 23** Goitre Instruments
- 24** Dermatology Instruments
- 25** Stomach, Intestine and Rectum Instruments
- 26** Bladder and Urology Instruments
- 27** Gynecology Instruments
- 28** Obstetrics Instruments
- 29** Cardiovascular Instruments
- 30** Ophthalmology Instruments
- 31** Neuro and Laminectomy Instruments
- 32** Micro Instruments
- 33** Otolaryngology Instruments
- 34** Rhinology Instruments
- 35** Oral Instruments
- 36** Tonsil Instruments
- 37** Broncho-Esophagoscopy Instruments
- 38** Sterilizing Instruments
- 39** Asepsis





**Aly**  
10-01000-17  
17cm/6¾"



**Wartenberg**  
10-01004-19  
19cm/7½"



**Weber**  
10-01008-09  
9cm/3½"



wood

**Pinard**  
10-01012-18  
18cm/7"



aluminium

**Pinard**  
10-01016-15  
15cm/6"



**Chestpiece only**  
10-01020-01

**Ford**  
10-01020-00



**Chestpiece only**  
10-01024-01

**Dual**  
10-01024-00

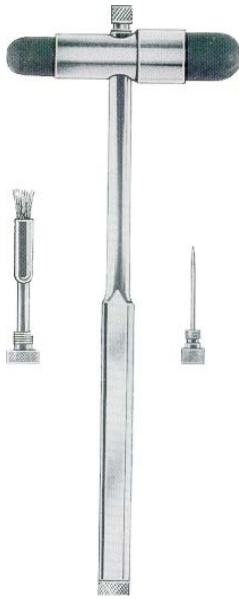

**Buck**  
10-01028-18  
18cm/7"



**Buck**  
10-01032-18  
18cm/7"



**Troemner**  
10-01036-24  
24cm/9½"



**Taylor**  
10-01040-1616cm/6 ½"  
10-01040-1818cm/7"  
10-01040-2020cm/8"

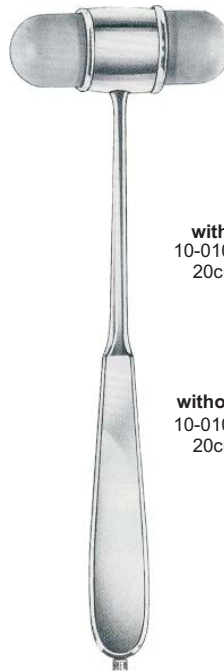

**Dejerine**  
20cm/8"

**withpin**  
10-01044-20  
20cm/8"

**withoutpin**  
10-01046-20  
20cm/8"



**Berliner**  
10-01050-20  
20cm/8"



**Traube**  
10-01054-16  
16cm/6 1/4"



**Troemner**  
10-01058-21  
21cm/8 1/4"



**Divers-Duoflex**  
10-01062-22  
22cm/8 3/4"



**Babinsky**  
10-01066-2222cm/8 7/4  
10-01066-2525cm/10"



**Rabiner**  
10-01068-23  
23cm/9 1/4"



**NationalHospital**  
10-01070-33  
33cm/13"



**QueenSqaure**  
10-01074-26  
26cm/10 1/4"



10-01078-00



10-01082-00



10-01086-00



**Jansen**  
10-01092-00



for children 10-01096-01      for adults 10-01096-02

**Collin**

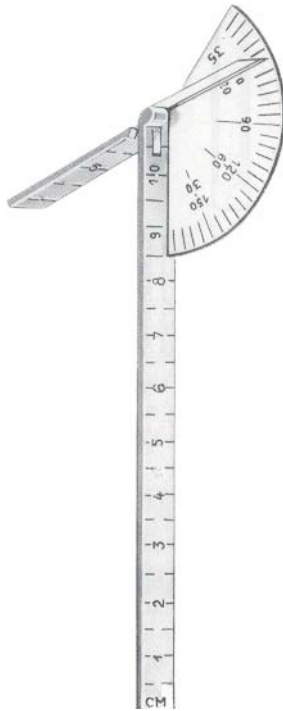

**Caroll**  
10-01104-14  
14cm/5½"

Goniometer

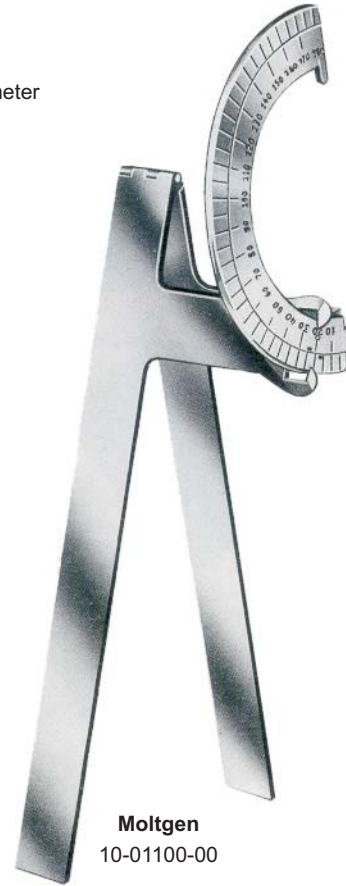

**Moltgen**  
10-01100-00



**Townley**  
10-01108-10  
10cm/4"





**Standard(Nelson)**

Ømm	11cm/4 1/2"
3.0	11-01112-30
3.5	11-01112-35
4.0	11-01112-40
4.5	11-01112-45
5.0	11-01112-50
5.5	11-01112-55
6.0	11-01112-60



**Standard(Nelson)**

Ømm	12cm/4 3/4"
3.0	11-01116-30
3.5	11-01116-35
4.0	11-01116-40
4.5	11-01116-45
5.0	11-01116-50
5.5	11-01116-55
6.0	11-01116-60



**Standard(Nelson)**

Ømm	12cm/4 3/4"
3.0	11-01120-30
3.5	11-01120-35
4.0	11-01120-40
4.5	11-01120-45
5.0	11-01120-50
5.5	11-01120-55
6.0	11-01120-60



**Universal**

11-01124-03=3Setof3  
11-01124-04=4Setof4



Ø6



4 1/2



3



1 3/4 mm



**Universal**

11-01128-03=3Setof3  
11-01128-04=4Setof4

Ø 2mm



**Landau**  
11-01132-16  
16cm/6¼"

Ø 2mm



**Landau**  
11-01136-19  
19cm/7½"

Ø 13.5mm



**Peau**  
11-01140-16  
16cm/6¼"

Ø 8mm

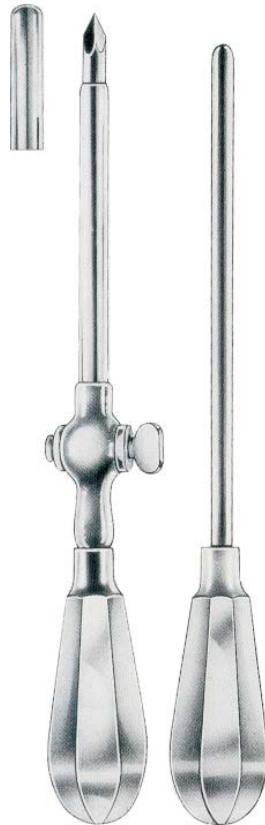

**Buelau**  
11-01144-24  
24cm/9½"



**Nelson**  
 Ø mm 21cm/8¼"  
 7.5 11-01148-07  
 9.0 11-01148-09  
 10.5 11-01148-10  
 12.0 11-01148-12



**Ochsner**  
 Ø mm 14.5cm/5½"  
 4.0 11-01152-40  
 4.6 11-01152-46  
 5.5 11-01152-55  
 6.5 11-01152-65

Ø5.5mm



**Krause**  
 11-01156-15  
 15cm/6"

Ø2.25mm

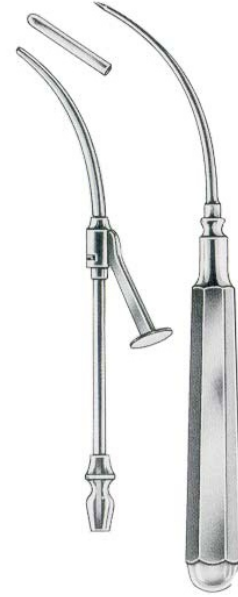

**Coakley**  
 11-01160-16  
 16cm/6¼"

Ø1.8mm



**Lichtwitz**  
 11-01164-19  
 19cm/7½"

Ø3mm



**Douglas**  
 11-01168-11  
 11.5cm/4 ½"



11-01172-11  
 11.5cm/4 ½"



**Pierce**  
 Ø mm  
 3.0 11-01176-03  
 4.0 11-01176-04  
 5.0 11-01176-05



Frazier	
Ømm	Charr./Fr.
2	6 12-01180-06
2 1/3	7 12-01180-07
2 2/3	8 12-01180-08
3	9 12-01180-09
3 1/3	10 12-01180-10
3 2/3	11 12-01180-11
4	12 12-01180-12
5	15 12-01180-15



Ferguson	
Ømm	Charr./Fr.
2	6 12-01184-06
2 1/3	7 12-01184-07
2 2/3	8 12-01184-08
3	9 12-01184-09
3 1/3	1012-01184-10
3 2/3	1112-01184-11
4	1212-01184-12

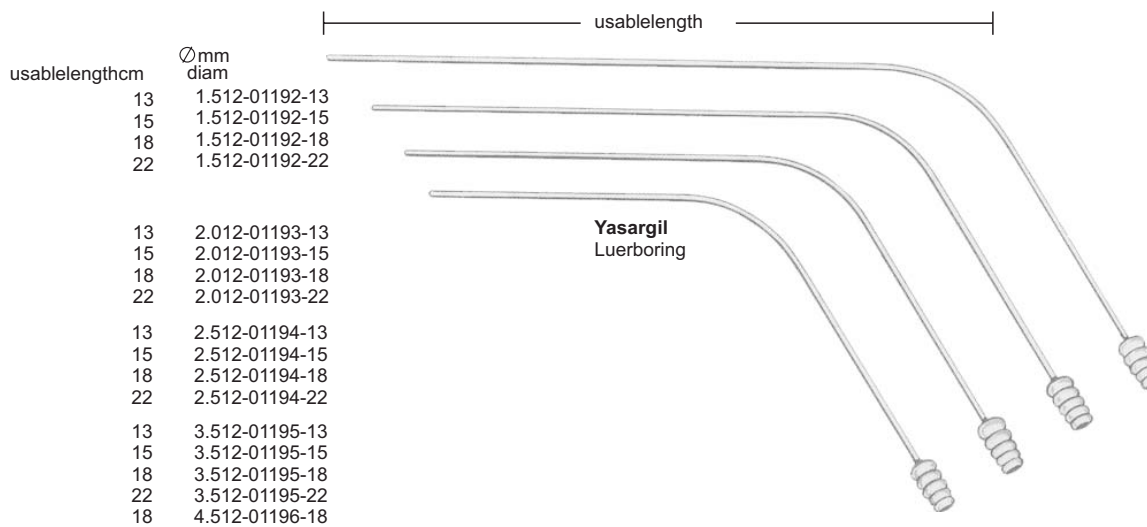

usablelengthcm	Ømm diam
13	1.512-01192-13
15	1.512-01192-15
18	1.512-01192-18
22	1.512-01192-22
13	2.012-01193-13
15	2.012-01193-15
18	2.012-01193-18
22	2.012-01193-22
13	2.512-01194-13
15	2.512-01194-15
18	2.512-01194-18
22	2.512-01194-22
13	3.512-01195-13
15	3.512-01195-15
18	3.512-01195-18
22	3.512-01195-22
18	4.512-01196-18

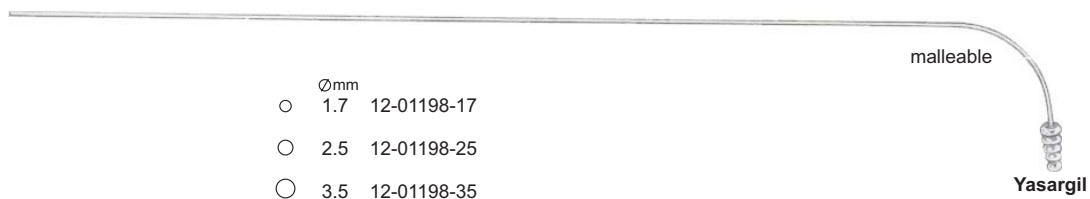

Ømm	
○ 1.7	12-01198-17
○ 2.5	12-01198-25
○ 3.5	12-01198-35

## BrainSuctionTubes



**Frazier**  
 ∅ 2.0mm 12-01202-20  
 2.5mm 12-01202-25  
 3.0mm 12-01202-30  
 13cm/5"



**Plester**  
 ∅ 1.5mm 12-01206-15  
 2.0mm 12-01206-20  
 2.5mm 12-01206-25  
 3.0mm 12-01206-30  
 19.5cm/7¾"



**Adson**  
 12-01210-02  
 21cm/8¼"  
 ∅4mm

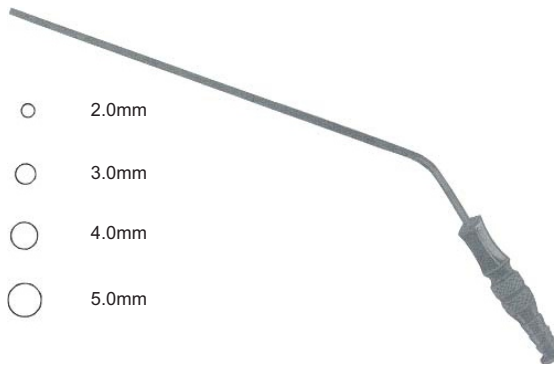

- 2.0mm
- 3.0mm
- 4.0mm
- 5.0mm

∅ malleable, black  
 2mm 12-01214-02  
 3mm 12-01214-03  
 4mm 12-01214-04  
 5mm 12-01214-05  
 19.5cm/7¾"





**Yankauer**  
 12-01218-27  
 27cm/10½"



**Yankauer**  
 12-01219-27  
 27cm/10½"

with stopcock



**Yankauer**  
 12-01220-01



Fig.0  
 12-01220-10



Fig.1  
 12-01220-11



Fig.2  
 12-01220-12



Fig.3  
 12-01220-13

12-01220-50 SET



∅ 6mm  
 round

**Nuboer**  
 12-01224-01  
 21cm/8¼"



6mm  
 ovale

**Nuboer**  
 12-01224-02  
 21cm/8¼"

∅ 6mm



**Andrew-Pynchon**  
 12-01228-23  
 23cm/9"

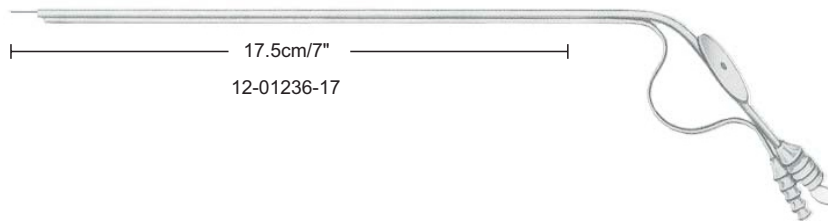

Ø 6mm



**Baby-Poole**  
 12-01240-20  
 20cm/8"

Ø10mm



**Poole**  
 12-01240-22  
 22cm/8¾"

Ø 8mm



**Poole**  
 12-01244-22  
 22cm/8¾"



**Yankauer**  
 12-01248-34  
 34.5cm/13½"

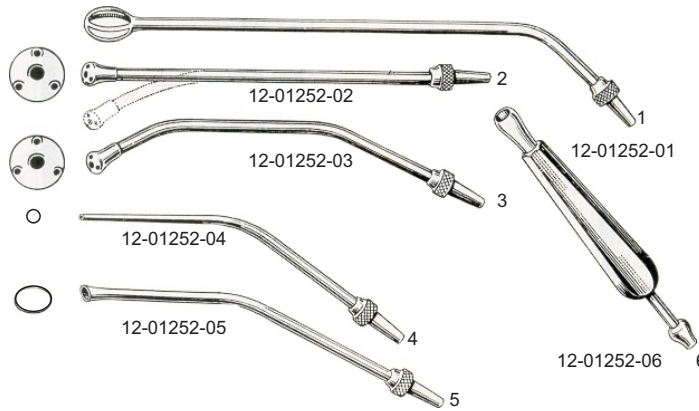

**Yankaueruniversal**  
 CompleteSet  
 12-01252-60

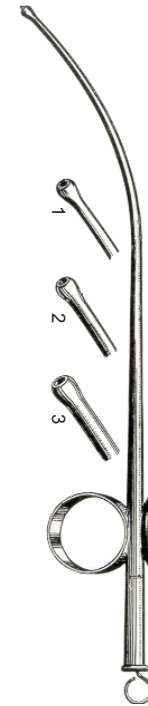

**Magill**  
 12-01256-01=20cm/8"  
 12-01256-02=20cm/8"  
 12-01256-03=20cm/8"



**Millin**  
 12-01262-30  
 30cm/12"



**Simpson-Smith**  
 12-01266-00



**Schimmelbusch**  
 12-01272-01 Child  
 12-01272-02 Adult



**Magill**  
 12-01280-15 15cm/6" Infant  
 12-01280-20 20cm/8" Child  
 12-01280-25 25cm/10" Adult



**Yankauer**  
 12-01276-01 Child  
 12-01276-02 Adult



**Connel**  
 12-01284-01 Child  
 12-01284-02 Adult



12-01288-01



**Lumbard-Mayo**  
 12-01288-02



12-01288-03

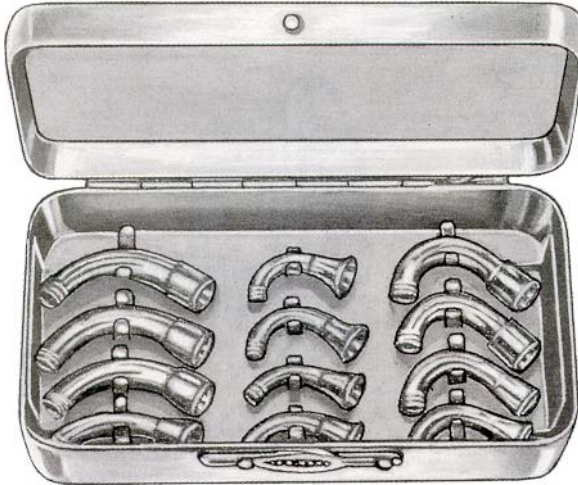

**Magill**  
ConnectionSet  
12-01292-00



**Magill (Nasal)**

	mmdia
12-01292-01	5.5
12-01292-02	6.5
12-01292-03	7.5
12-01292-04	8.0
12-01292-05	8.5
12-01292-06	9.5
12-01292-07	10.0
12-01292-08	10.5



**Magill (Aural)**

	mmdia
12-01296-01	5.5
12-01296-02	6.5
12-01296-03	7.5
12-01296-04	8.0
12-01296-05	8.5
12-01296-06	9.5
12-01296-07	10.0
12-01296-08	10.5



**Cobb**  
12-01300-01 Small  
12-01300-02 Medium  
12-01300-03 Large

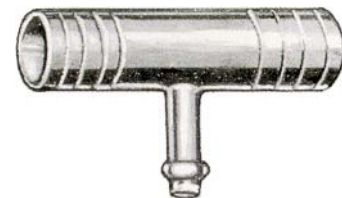

**Ayre**  
12-01304-01 Small  
12-01304-02 Medium  
12-01304-03 Large

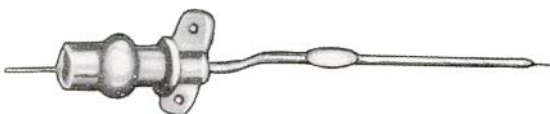

**HamiltonBailey**  
12-01308-01 Infant  
12-01308-02 Child  
12-01308-03 Adult

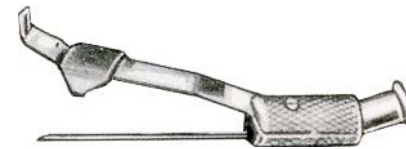

**Mitchell**  
12-01312-18  
12-01312-20  
38mm





**McIntosh**  
12-01316-30  
12-01316-40

12-01316-30  
LaryngoscopeSet  
Consistingof:  
12-01332-00BatteryHandle(withoutbatteries)  
12-01316-11McIntoshblade, Fig1  
12-01316-12ditto, Fig2  
12-01316-13ditto, Fig3



12-01316-10

12-01316-11



12-01316-12



12-01316-13



12-01316-14

12-01316-40  
LaryngoscopeSet  
Consistingof:  
12-01332-00BatteryHandle(withoutbatteries)  
12-01316-11McIntoshblade, Fig1  
12-01316-12 McIntoshblade , Fig2  
12-01316-13 McIntoshblade , Fig3  
12-01316-14McIntoshblade, Fig4

McIntoshLaryngoscopeBlades  
12-01316-10 Fig0, Workinglength 55mm, baby's  
12-01316-11 Fig1, Workinglength 75mm, children's  
12-01316-12 Fig2, Workinglength 90mm, adolescent's  
12-01316-13 Fig3, Workinglength 110mm, women's  
12-01316-14 Fig4, Workinglength 135mm, men's



12-01320-30  
 LaryngoscopeSet  
 Consistingof:  
 12-01332-00BatteryHandle(withoutbatteries)  
 12-01320-12Guedel-NegusBlade, Fig2  
 12-01320-13ditto, Fig3  
 12-01320-14ditto, Fig4

**Guedel-Negus**  
 12-01320-30  
 12-01320-40

12-01320-40  
 LaryngoscopeSet  
 Consistingof:  
 12-01332-00BatteryHandle(withoutbatteries)  
 12-01320-11Guedel-NegusBlade, Fig1  
 12-01320-12 Guedel-NegusBlade, Fig2  
 12-01320-13 Guedel-NegusBlade, Fig3  
 12-01320-14Guedel-NegusBlade, Fig4



12-01320-11



12-01320-12



12-01320-13



12-01320-14

**GuedelLaryngoscopeBlades**  
 12-01320-11 Fig1, workinglength 70mm, children's  
 12-01320-12 Fig2, workinglength 90mm, adolescent's  
 12-01320-13 Fig3, workinglength110mm, women's  
 12-01320-14 Fig4, workinglength135mm, men's



**Foregger**  
12-01324-30  
12-01324-40

12-01324-30  
LaryngoscopeSet  
Consistingof:  
12-01332-00BatteryHandle(withoutbatteries)  
12-01324-12Foregger Blade, Fig2  
12-01324-13ditto, Fig3  
12-01324-14ditto, Fig4

12-01324-40  
LaryngoscopeSet  
Consistingof:  
12-01324-00BatteryHandle(Withoutbatteries)  
12-01324-11ForeggerBlade, Fig1  
12-01324-12ForeggerBlade, Fig2  
12-01324-13ForeggerBlade, Fig3  
12-01324-14ForeggerBlade, Fig4



12-01324-11



12-01324-12



12-01324-13



12-01324-14

ForeggerLaryngoscopeBlade,  
12-01324-11 Fig1, workinglength 70mm, children's  
12-01324-12 Fig2, workinglength 90mm, adolescent's  
12-01324-13 Fig3, workinglength 110mm, women's  
12-01324-14 Fig4, workinglength 135mm, men's



Workinglength55mm  
12-01328-10

Workinglength80mm  
12-01328-11

12-01328-20  
 LaryngoscopeSet,BabyandInfant,  
 consistingof:  
 12-01332-00BatteryHandle(withoutbattery)  
 12-01328-10Miller-babyblade, Fig0  
 workinglength55mm  
 12-01328-11ditto, Fig1workinglength80mm

**Miller-Baby**  
12-01328-20



32mmdia  
12-01332-00



28mmdia  
12-01336-00



18mmdia  
12-01340-00



**Negus**  
18mmdia  
12-01344-00





No.3

13-01348-03



No.3

13-01352-03



No.4

13-01356-04



No.4

13-01360-04

doublehandle  
number3+number4



No.7

13-01364-07



No.7k

13-01368-17



No.8

13-01372-08



No.9

13-01376-09



13-01380-34



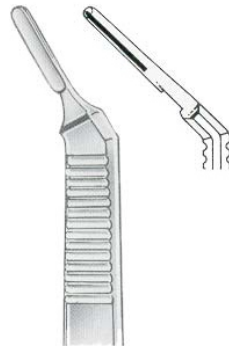

3L  
13-01384-13



4L  
13-01388-14



No.3L  
13-01392-03



No.4L  
13-01396-04



No.5  
13-01400-05  
15cm/6"



No.5A  
13-01404-15  
15cm/6"



13-1408-01  
21cm/8¼"



13-01408-03



17cm/6 /"



Fig. 1

13-01412-01



Fig. 2

13-01412-02



Fig. 3

13-01412-03



Fig. 4

13-01412-04



Fig. 5

13-01412-05



Fig. 6

13-01412-06



Fig. 7

13-01412-07



Fig. 8

13-01412-08



Fig. 9

13-01412-09



Fig. 10

13-01412-10





**Dieffenbach**  
 17cm/6¾"



Fig.1  
 13-01420-01



Fig. 2  
 13-01420-02



Fig. 3  
 13-01420-03



Fig. 4  
 13-01420-04



Fig. 5  
 13-01420-05



Fig.6  
 13-01420-06



Fig.7  
 13-01420-07



Fig.8  
 13-01420-08



Fig.9  
 13-01420-09



Fig.15  
 13-01420-15



Fig.16  
 13-01420-16

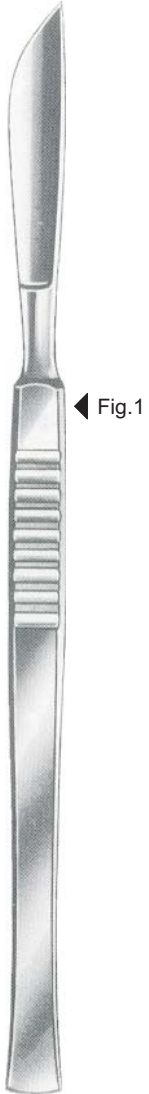

◀ Fig.1

**Bergmann**  
13-01424-01  
14.5cm/5¾"



Fig.2  
13-01424-02



Fig.3  
13-01424-03



Fig.4  
13-01424-04



**Dieffenbach**  
13cm/5¼"



Fig.1  
13-01428-01



Fig.2  
13-01428-02



Fig.3  
13-01428-03



Fig.4  
13-01428-04



Fig.5  
13-01428-05



Fig.6  
13-01428-06



Fig.7  
13-01428-07



Fig.8  
13-01428-08



Fig.9  
13-01428-09



Fig.10  
13-01428-10



Fig.11  
13-01428-11



Fig.12  
13-01428-12



**Simon**  
20cm/8"



**Fig.1**  
13-01432-01



**Fig.2**  
13-01432-02



**Fig.3**  
13-01432-03



**Fig.4**  
13-01432-04



**Ulrich**  
22.5cm/9"



**Fig.1**  
13-01436-01



**Fig.2**  
13-01436-02



**Fig.3**  
13-01436-03



**Simon**  
23.5cm/9 1/4"



**Fig.1**  
13-01440-01



**Fig.2**  
13-01440-02



**Fig.3**  
13-01440-03



**Fig.4**  
13-01440-04



13-01444-01  
7.5cm/3"



13-01444-02  
8cm/3 1/4"





Flapknife

Interosseusknife

Phalangealknife

Length of blades		Liston	Catlin	Langenbeck	13-01464-09	13-01468-11
cm	in					
9.5	3 3/4					
11.0	4 1/2					
12.0	4 3/4			13-01460-12		
13.0	5	13-01448-13				
15.0	6					
16.0	6 1/4	13-01448-16		13-01456-16		
17.0	6 3/4		13-01452-17			
19.0	7 1/2	13-01448-19		13-01456-19		
20.0	8		13-01452-20			
22.0	8 3/4	13-01448-22		13-01456-22		





**Langenbeck**  
 13-01472-01  
 18cm/7"

**Virchow**

Lengthofblades

8.5 cm/3½"			13-01488-08
11.0 cm/4½"		13-01480-11	13-01484-11
14.0 cm/5½"		13-01480-14	
16.0 cm/6¼"	13-01476-16		
17.0 cm/6¾"		13-01480-17	
20.0 cm/8"	13-01476-20		
24.0 cm/9½"	13-01476-24		

Autopsyknives  
Lengthofblades  
19.5cm/7 3/4"



13-01496-19

Lengthofblades  
9.5cm/3 3/4"



**Virchow**  
13-01492-09

Cartilageknives



13-01500-01



13-01504-01

Woodenhandle

Metalhandle

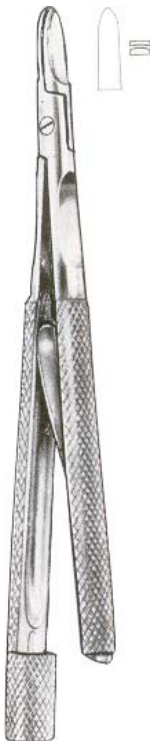

**Troutman-Chris**  
 13-01508-09  
 9cm/3 1/2"



**Troutman-Chris**  
 13-01509-09  
 9cm/3 1/2"



13-01512-11  
 11cm/4 1/2"



**Castroviejo**  
 13-01516-13  
 13cm/5 1/4"



13-01520-18  
 18cm/7"



SkullBreaker

13-01524-14  
14cm/5 1/2"

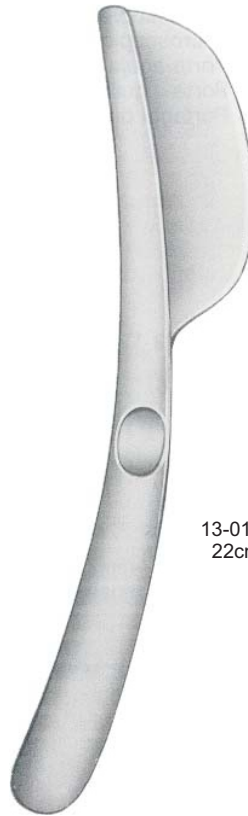

Rachiotome

13-01528-22  
22cm/8 3/4"



23mm

Osteotome

13-01532-13  
13cm/5"



**Brunetti**

13-01536-28  
13-01537-28  
28.5cm/11 1/4"

Musclehooks



13-01540-06  
6.5cm/2 1/2"



13-01544-07  
7cm/2 3/4"



13-01548-01

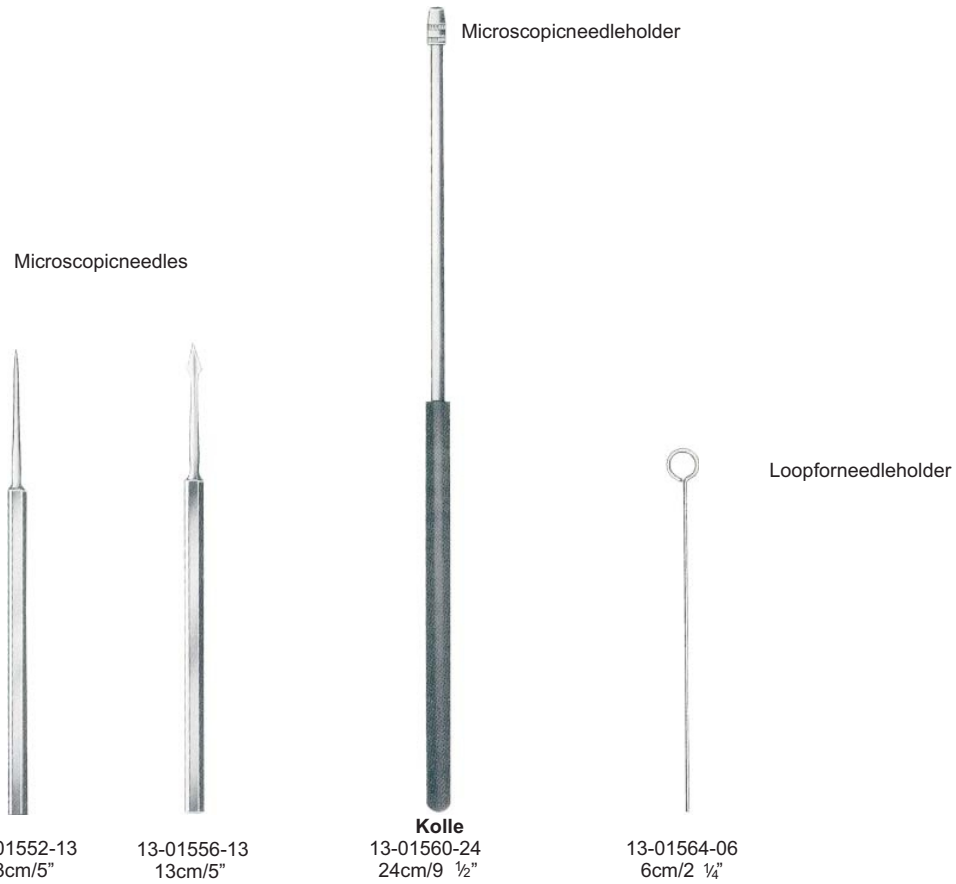

Postmortemneedles







13-01572-00

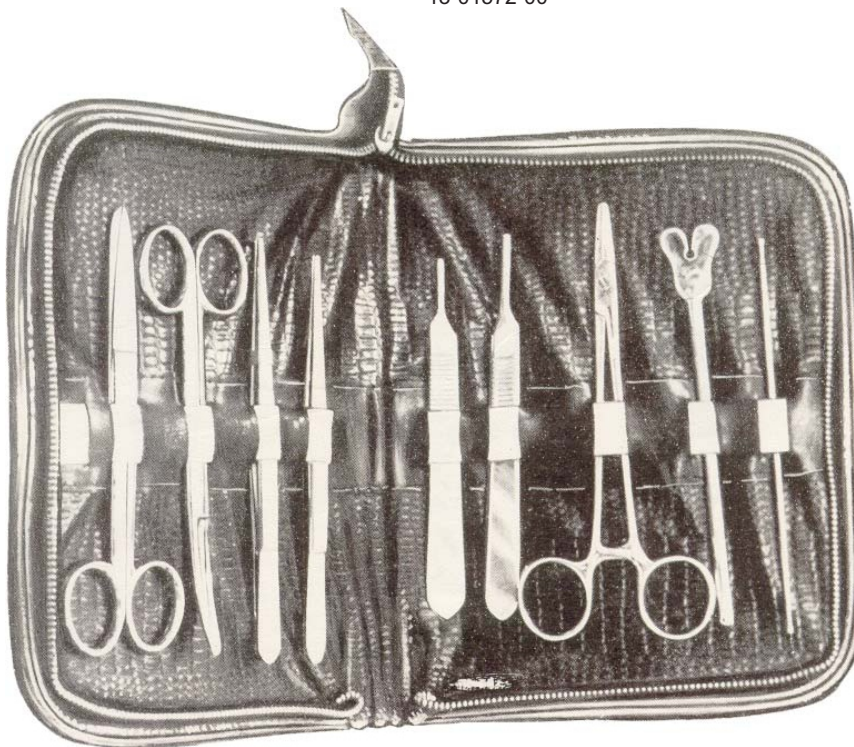

13-01576-00





Straight 14-01580-14  
Curved 14-01581-14  
14.5cm/5¾"

**Mayo**  
Straight 14-01584-14 14.5cm/5¾"  
14-01584-17 17.0cm/6¾"  
14-01584-23 23.0cm/9"  
Curved 14-01585-14  
14-01585-17  
14-01585-23

SawEdge

**Mayo-Stillle**  
Straight 14-01588-15 15.0cm/6"  
14-01588-17 17.0cm/6¾"  
Curved 14-01589-15  
14-01589-17

**Lexer**  
Straight 14-01592-16  
Curved 14-01593-16  
16cm/6¼"



**Baby-Metzenbaum**  
Straight 14-01596-11  
Curved 14-01597-11  
11.5cm/4½"

**Metzenbaum-Fine**  
Straight 14-01600-14  
Curved 14-01601-14  
14.5cm/5¾"

**Metzenbaum-Fine**  
Straight 14-01604-18 18cm/7"  
14-01604-20 20cm/8"  
14-01604-23 23cm/9"  
Curved 14-01605-18  
14-01605-20  
14-01605-23

Sawedge



**Sims**  
 Straight 14-01608-20 20cm/8"  
 Curved 14-01609-20 23cm/9"  
 14-01608-23 23cm/9"  
 14-01609-23



**Siebold**  
 14-01613-24  
 24cm/9 1/2"



**Jameson**  
 16-01617-15 15cm/6"  
 16-01617-18 18cm/7"



**Reynolds**  
 Straight 16-01620-15 15cm/6"  
 Curved 16-01621-15 15cm/6"



Straight 14-01624-11 11.5cm/4 1/2"  
 Curved 14-01625-11



Straight 14-01628-11 11.5cm/4 1/2"  
 Curved 14-01629-11



**Plastic Surgery**  
 Straight 14-01632-12 12cm/4 3/4"  
 Curved 14-01633-12



**Wagner**  
 Straight 14-01636-12 12cm/4 3/4"  
 Curved 14-01637-12

SawEdge



14-01641-11  
11.5cm/4 1/2"



14-01645-14  
14cm/5 1/2"



**Reynolds**  
14-01649-13  
13cm/5"

Endarterectomy  
Scissors



**Potts-Smith**  
19cm/7 1/2"



25°  
14-01653-19

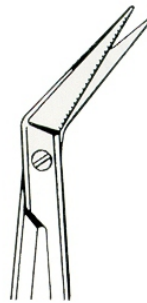

45°  
14-01655-19

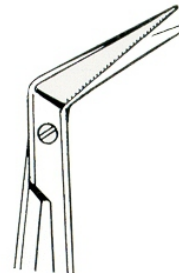

60°  
14-01657-19



14-01661-17  
17cm/6 3/4"



**Lister**

14-01665-1414.5cm/5 3/4"  
14-01665-1818cm/7"  
14-01665-2020cm/8"

SawEdge



**Braun-Stadler**

14-01669-1414.5cm/5 3/4"  
14-01669-2222cm/8 3/4"



**Stevens**

Straight 14-01672-11 11.5cm/4 1/2"  
Curved 14-01673-11



**Heymann**

14-01677-18  
18cm/7"



**Fomon**

14-01681-13  
13cm/5"



**Fomon**

14-01685-13  
13cm/5"



**Cottle**

14-01689-16  
16cm/6 1/4"



Straight

Standard  
Fig. 1

10.0	cm/4"	14-01692-10
11.5	cm/4 1/2"	14-01692-11
13.0	cm/5"	14-01692-13
14.5	cm/5 3/4"	14-01692-14
15.5	cm/6"	14-01692-15
16.0	cm/6 1/4"	14-01692-16
18.0	cm/7"	14-01692-18
20.0	cm/8"	14-01692-20



Straight

Standard  
Fig. 2

14-01694-10
14-01694-11
14-01694-13
14-01694-14
14-01694-15
14-01694-16
14-01694-18
14-01694-20



Straight

Standard  
Fig. 3

14-01696-10
14-01696-11
14-01696-13
14-01696-14
14-01696-15
14-01696-16
14-01696-18
14-01696-20



Straight

Standard  
14.5cm/5 3/4"

## PinsmedTC

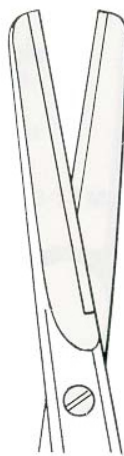

Fig. 1  
14-01700-14

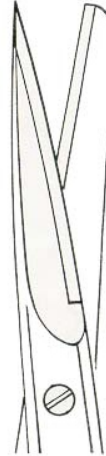

Fig. 2  
14-01702-14



Fig. 3  
14-01704-14



Curved

Standard  
Fig. 1

- 14-01707-10
- 14-01707-11
- 14-01707-13
- 14-01707-14
- 14-01707-15
- 14-01707-16
- 14-01707-18
- 14-01707-20



Curved

Standard  
Fig. 2

- 14-01709-10
- 14-01709-11
- 14-01709-13
- 14-01709-14
- 14-01709-15
- 14-01709-16
- 14-01709-18
- 14-01709-20



Curved

Standard  
Fig. 3

- 14-01711-10
- 14-01711-11
- 14-01711-13
- 14-01711-14
- 14-01711-15
- 14-01711-16
- 14-01711-18
- 14-01711-20

- |      |        |
|------|--------|
| 10.0 | cm/4"  |
| 11.5 | cm/4½" |
| 13.0 | cm/5"  |
| 14.5 | cm/5¾" |
| 15.5 | cm/6"  |
| 16.0 | cm/6¼" |
| 18.0 | cm/7"  |
| 20.0 | cm/8"  |

## PinsmedTC



Curved

Standard  
14.5cm/5¾"



Fig. 1  
14-01715-14



Fig. 2  
14-01717-14



Fig. 3  
14-01719-14





**Grazil**

14-01722-13 13.0cm/5" 14-01724-13  
 14-01722-14 14.5cm/5 3/4" 14-01724-14  
 Straight



**Grazil**

14-01727-13 13.0cm/5" 14-01729-13  
 14-01727-14 14.5cm/5 3/4" 14-01729-14  
 Curved



**Straight**

14-01732-14



**Curved**

14-01733-14



**Straight**

14-01736-15



**Curved**

15.5cm/6"

14-01737-15

## *PinsmedTC*



**Lexer**  
Straight  
14-01740-16  
16cm/6 ¼"



**Lexer**  
Curved  
14-01741-16  
16cm/6 ¼"



**Lexer**  
Straight  
14-01744-16  
16cm/6 ¼"



**Lexer**  
Curved  
14-01745-16  
16cm/6 ¼"

## *PinsmedTC*



**Lexer-Fine**  
Straight  
14-01748-16  
16cm/6 ¼"



**Lexer-Fine**  
Curved  
14-01749-16  
16cm/6 ¼"



**Lexer-Fine**  
Straight  
14-01752-16  
16cm/6 ¼"



**Lexer-Fine**  
Curved  
14-01753-16  
16cm/6 ¼"

## IncisionScissors



14-01756-13 13.0cm/5 1/4"  
14-01756-14 14.5cm/5 3/4"



14-01760-15  
15.5cm/6"



**Richter**  
14-01763-14  
14.5cm/5 3/4"

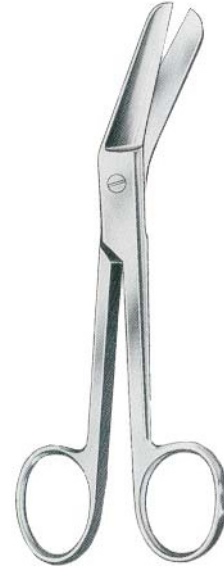

**Richter**  
14-01767-14  
14.5cm/5 3/4"



**Fergusson**  
14-01771-18  
18cm/7"



**NewSuture**  
14-01775-14  
14.5cm/5 3/4"

## PinsmedTC



**Mayo  
Straight**

14-01778-1414.5cm/5 3/4"  
14-01778-1515.0cm/6"  
14-01778-1717.0cm/6 3/4"  
14-01778-1919.0cm/7 1/2"  
14-01778-2323.0cm/9"



**Mayo  
Curved**

14-01779-1414.5cm/5 3/4"  
14-01779-1515.0cm/6"  
14-01779-1717.0cm/6 3/4"  
14-01779-1919.0cm/7 1/2"  
14-01779-2323.0cm/9"



**Mayo  
Straight**

14-01782-1414.5cm/5 3/4"  
14-01782-1718.0cm/7"  
14-01782-2313.0cm/9"



**Mayo  
Curved**

14-01783-1414.5cm/5 3/4"  
14-01783-1718.0cm/7"  
14-01783-2313.0cm/9"

## PinsmedTC



**Mayo-Stille  
Straight**

14-01786-1515cm/6"  
14-01786-1717cm/6 3/4"  
14-01786-1919cm/7 1/2"  
14-01786-2121cm/8 1/4"



**Mayo-Stille  
Curved**

14-01787-1515cm/6"  
14-01787-1717cm/6 3/4"  
14-01787-1919cm/7 1/2"  
14-01787-2121cm/8 1/4"

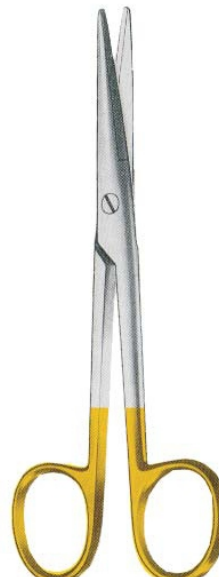

**Mayo-Stille  
Straight**

14-01790-1615cm/6"  
14-01790-1717cm/6 3/4"



**Mayo-Stille  
Curved**

14-01791-1615cm/6"  
14-01791-1717cm/6 3/4"



Straight

**Mayo-Noble**  
14-01794-17  
17cm/6 3/4"



Curved

**Mayo-Noble**  
14-01795-17  
17cm/6 3/4"



Straight

**Baby-Metzenbaum**  
14-01798-11  
11.5cm/4 1/2"



Curved

**Baby-Metzenbaum**  
14-01799-11  
11.5cm/4 1/2"



**Metzenbaum-Fine**  
14-01802-14  
14.5cm/5 3/4"

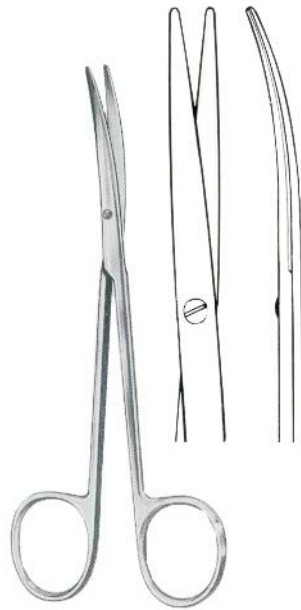

**Metzenbaum-Fine**  
14-01803-14  
14.5cm/5 3/4"

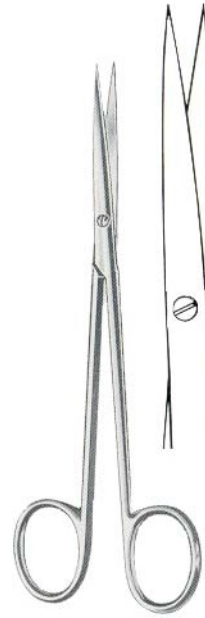

**Metzenbaum-Fine**  
14-01806-14  
14.5cm/5 3/4"



**Metzenbaum-Fine**  
14-01807-14  
14.5cm/5 3/4"

Straight



Fig1

**Metzenbaum**  
14-01810-14  
14.5cm/5 3/4"



Fig2

**Metzenbaum**  
14-01812-14  
14.5cm/5 3/4"

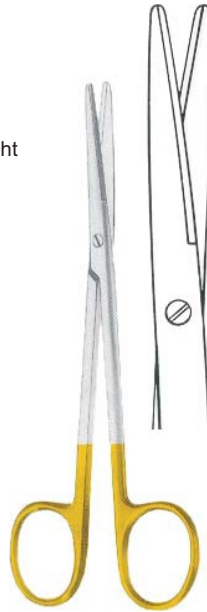

Fig3

**Metzenbaum**  
14-01814-14  
14.5cm/5 3/4"

## *PinsmedTC*

Straight



**Metzenbaum**  
14-01818-14  
14.5cm/5 3/4"

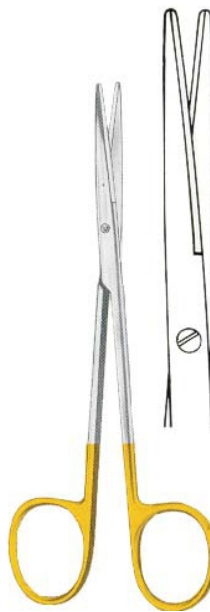

**Metzenbaum-Fine**  
14-01820-14  
14.5cm/5 3/4"

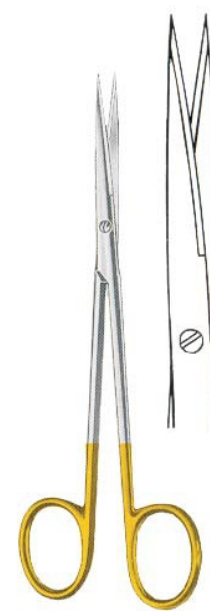

**Metzenbaum-Fine**  
14-01822-14  
14.5cm/5 3/4"



Curved



Fig.1  
**Metzenbaum**  
 14-01825-14  
 14.5cm/5 ¾"



Fig.2  
**Metzenbaum**  
 14-01827-14  
 14.5cm/5 ¾"



Fig.3  
**Metzenbaum**  
 14-01829-14  
 14.5cm/5 ¾"

## *PinsmedTC*

Curved

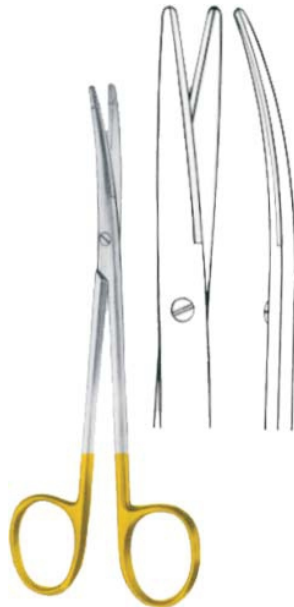

**Metzenbaum**  
 14-01831-14  
 14.5cm/5 ¾"



**Metzenbaum-Fine**  
 14-01833-14  
 14.5cm/5 ¾"



**Metzenbaum-Fine**  
 14-01835-14  
 14.5cm/5 ¾"

Straight



**Metzenbaum-Fine**

18cm/7"	14-01838-18
20cm/8"	14-01838-20
23cm/9"	14-01838-23
25cm/10"	14-01838-25
28cm/11"	14-01838-28
30cm/12"	14-01838-30



**Metzenbaum**

14-01840-18
14-01840-20
14-01840-23
14-01840-25
14-01840-28
14-01840-30



**Metzenbaum**

14-01842-18
14-01842-20
14-01842-23
14-01842-25
14-01842-28
14-01842-30



**Metzenbaum**

14-01844-18
14-01844-20
14-01844-23
14-01844-25
14-01844-28
14-01844-30

**PinsmedTC**

Straight



**Metzenbaum**

18cm/7"	14-01848-18
20cm/8"	14-01848-20
23cm/9"	14-01848-23
25cm/10"	14-01848-25
28cm/11"	14-01848-28
30cm/12"	14-01848-30



**Metzenbaum-Fine**

14-01850-18
14-01850-20
14-01850-23
14-01850-25
14-01850-28
14-01850-30



**Metzenbaum-Fine**

14-01852-18
14-01852-20
14-01852-23
14-01852-25
14-01852-28
14-01852-30

Curved



	<b>Metzenbaum-Fine</b>	<b>Metzenbaum</b>	<b>Metzenbaum</b>	<b>Metzenbaum</b>
18cm/7"	14-01855-18	14-01857-18	14-01859-18	14-01861-18
20cm/8"	14-01855-20	14-01857-20	14-01859-20	14-01861-20
23cm/9"	14-01855-23	14-01857-23	14-01859-23	14-01861-23
25cm/10"	14-01855-25	14-01857-25	14-01859-25	14-01861-25
28cm/11"	14-01855-28	14-01857-28	14-01859-28	14-01861-28
30cm/12"	14-01855-30	14-01857-30	14-01859-30	14-01861-30

**PinsmedTC**

Curved



	<b>Metzenbaum</b>	<b>Metzenbaum-Fine</b>	<b>Metzenbaum-Fine</b>
18cm/7"	14-01865-18	14-01867-18	14-01869-18
20cm/8"	14-01865-20	14-01867-20	14-01869-20
23cm/9"	14-01865-23	14-01867-23	14-01869-23
25cm/10"	14-01865-25	14-01867-25	14-01869-25
28cm/11"	14-01865-28	14-01867-28	14-01869-28
30cm/12"	14-01865-30	14-01867-30	14-01869-30



**Sims**  
14-01870-20 20cm/8"  
14-01870-23 23cm/9"



**Straight**  
14-01872-20 20cm/8" 14-01874-20  
14-01872-23 23cm/9" 14-01874-23



**Sims**  
14-01977-20 20cm/8"  
14-01977-23 23cm/9"



**Curved**  
14-01879-20 20cm/8" 14-01881-20  
14-01879-23 23cm/9" 14-01881-23

## *PinsmedTC*



**Sims**  
14-01883-20 20cm/8"  
14-01883-23 23cm/7"



**Wertheim**  
14-01887-14 14.5cm/5 3/4"  
14-01887-19 19.5cm/7 3/4"  
14-01887-22 22.5cm/9"



Curved

**Dubois**  
14-01892-2727cm/10 1/2"



**Dubois**  
14-01893-2727cm/10 1/2"



Straight

**Doyen**  
14-01896-1616cm/6 1/4"  
14-01896-1818cm/7"

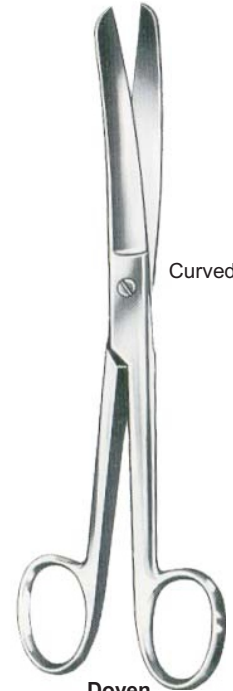

Curved

**Doyen**  
14-01897-1616cm/6 1/4"  
14-01897-1818cm/7"



**Kelly**  
14-01900-1616cm/6 1/4"  
14-01900-1818cm/7"



**Kelly**  
14-01901-1616cm/6 1/4"  
14-01901-1818cm/7"



Fig. 1  
14-01904-12



Fig. 2  
14-01906-12



Fig. 3  
14-01908-12

Straight

12cm/4¾"



Fig. 1  
14-01911-12



Fig. 2  
14-01913-12



Fig. 3  
14-01915-12

Curved

12cm/4¾"

SawEdge



Wagner  
12cm/4¾"

Curved



Fig. 1  
14-01916-12



Fig. 2  
14-01918-12



Fig. 3  
14-01920-12



Fig. 4  
14-01922-12



Fig. 1  
14-01923-12



Fig. 2  
14-01925-12



Fig. 3  
14-01927-12



Fig. 4  
14-01929-12

Straight

14-01932-12  
11.5cm/4½"

Curved



14-01933-12  
11.5cm/4½"





Straight

**Brophy(Sullivan)**  
14-01936-14

14.5cm/5 3/4"

14-01937-14



Curved



Straight

**Reynolds**  
14-01940-15  
14-01940-18

15cm/6"  
18cm/7"



Curved

14-01941-15  
14-01941-18

### EucleationScissors



**Jameson**  
14-01945-15  
15cm/6"



14-01948-12



14-01951-12

**Landolt**  
12.5cm/5"



14-01953-12



14-01955-12



Straight

Curved

**Standard**

9.0 cm/3½"	14-01958-09	14-01959-09	14-01961-09	14-01964-09	14-01965-09
10.5 cm/4¼"	14-01958-10	14-01959-10	14-01961-10	14-01964-10	14-01965-10
11.5 cm/4½"	14-01958-11	14-01959-11	14-01961-11	14-01964-11	14-01965-11

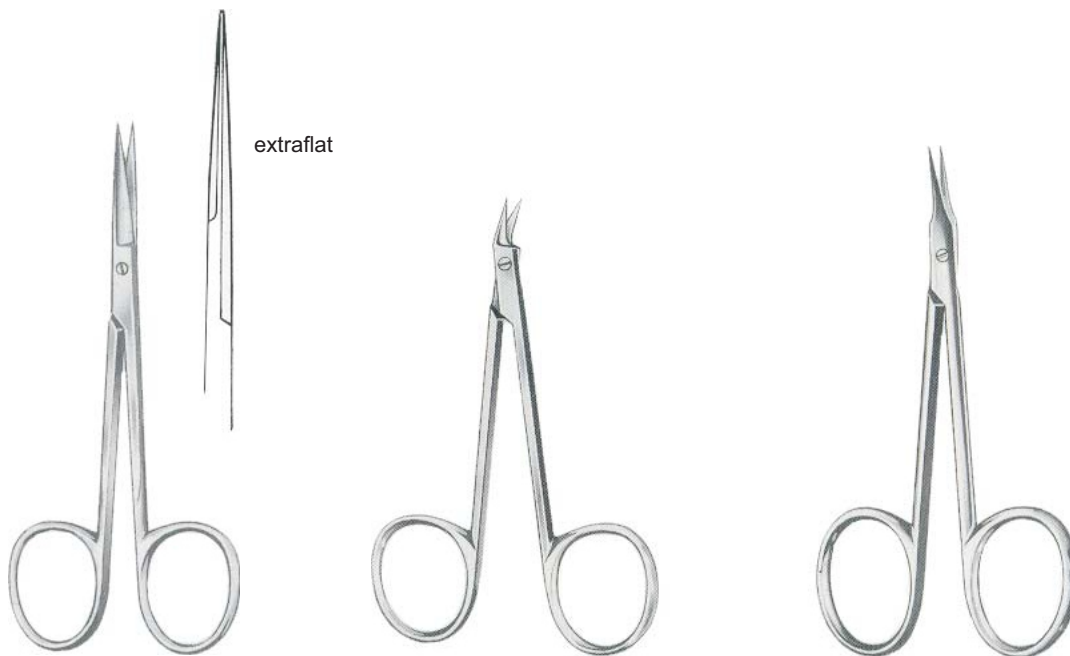

extraflat

14

14-01968-10  
10cm/4"

14-01971-09  
9cm/3½"

**Walton**  
14-01975-10  
10cm/4"

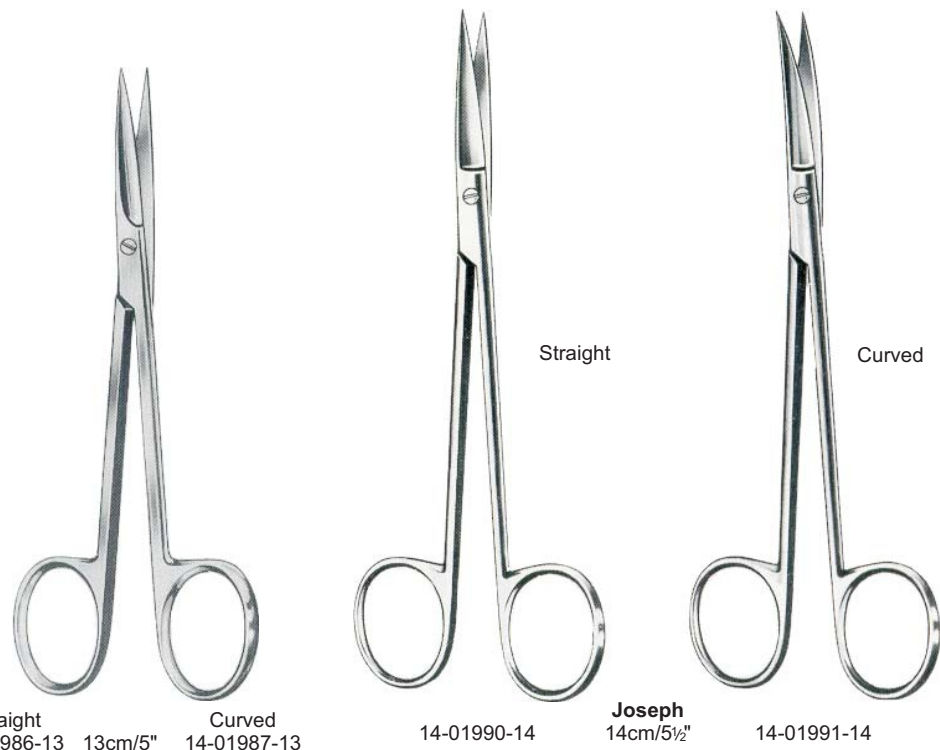



**Kilner(Regnell)**  
 14-01995-1212cm/4 3/4"  
 14-01995-1313cm/5"  
 14-01995-1515cm/6"



Coronary Scissors

14-01998-14  
 14.5cm/5 3/4"



14-02002-11  
 11.5cm/4 1/2"



**Potts-Smith**  
 14-02005-19  
 19.5cm/7 3/4"



**DeBakey**  
 14-02009-15  
 15.5cm/6"



**DeBakey**  
 14-02013-15  
 15.5cm/6"



**Favaloro**  
 14-02017-15  
 15cm/6"





**Martin-Cartilage**  
14-02039-20  
20cm/8"

SawEdge



**McIndoe**  
14-02042-19  
19cm/7½"



**Potts-Smith**  
14-02045-19  
19cm/7½"



**Satinsky**  
14-02049-24  
24.5cm/10"



**Klingenberg-Loth**  
14-02053-23  
23cm/9"





**DeBakey**  
18cm/7"

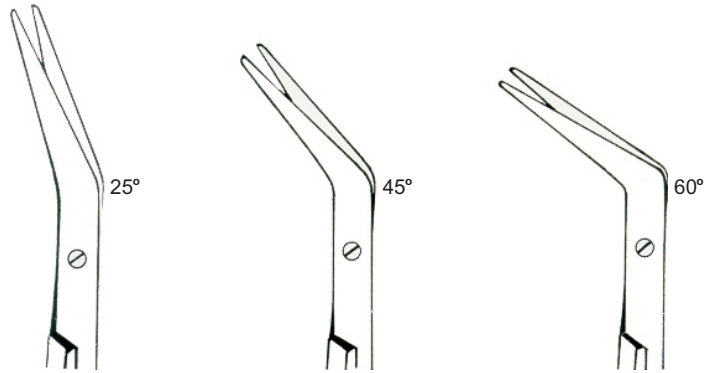

cm	In			
16.0cm	6¼"	14-02057-16	14-02059-16	14-02061-16
23.0cm	9"	14-02057-23	14-02059-23	14-02061-23
28.0cm	11"	14-02057-28	14-02059-28	14-02061-28



**Baby-Hegemann**  
13.5cm/5¼"

**Hegemann(Diethrich)**  
16cm/6¼"  
19cm/7½"

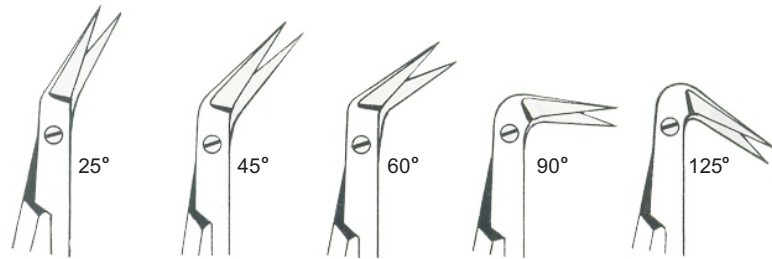

cm	In					
13.0cm	5¼"	14-02063-13	14-02065-13	14-02067-13	14-02069-13	14-02071-13
16.0cm	6¼"	14-02063-16	14-02065-16	14-02067-16	14-02069-16	14-02071-16
19.0cm	7½"	14-02063-19	14-02065-19	14-02067-19	14-02069-19	14-02071-19



**Hegemann(Diethrich)**  
14-02075-19  
19cm/7½"



18cm/7"

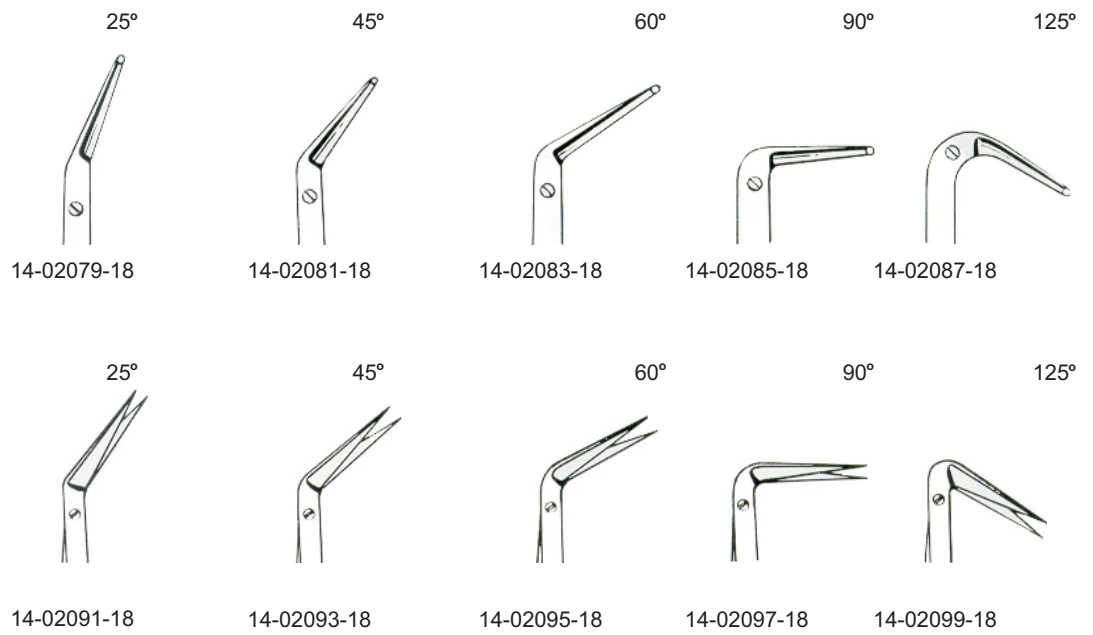

NerveDissectingScissors



14-02103-15  
15cm/6"

TonsilScissors



**Bottcher**  
14-02107-18  
18cm/7"



**Prince**  
14-02111-17  
17.5cm/7"

ArteriotomyScissors



**Tonnis-Adson-Fine**  
14-02115-17  
17.5cm/7"



Straight

**Tonnis**  
14-02118-18  
18cm/7"



Curved

**Tonnis**  
14-02119-18  
18cm/7"



**Tonnis-Adson**  
14-02123-17  
17.5cm/7"

**PinsmedTC**



**Tonnis-Adson**  
14-02125-17  
17.5cm/7"

Tonsil Scissors



**Good**  
14-02129-19  
19 cm/7 1/2"

Lobectomy Scissors



**Crafoord**  
14-02133-30  
30 cm/12"



**Finochietto**  
14-02137-27  
27 cm/10 1/2"

Enterotomy Scissors



14-02142-21  
21 cm/8 1/4"



14-02146-21  
21 cm/8 1/4"



14-02150-21  
21 cm/8 1/4"



**Busch**  
 14-02153-13 13cm/5"  
 14-02153-16 16cm/6 ¼"



**Schumacher**  
 14-02157-16  
 16cm/6 ¼"



**Mod.USA**  
 14-02160-10  
 10.5cm/4 ¼"



**Braun-Stadler**  
 14-02163-14  
 14cm/5 ½"



**Braun-Stadler**  
 14-02165-22  
 22cm/8 ½"



**PinsmedTC**



14-02169-23  
 23cm/9"

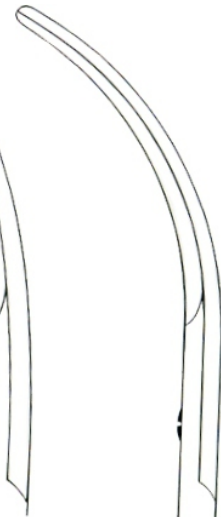

14-02171-23  
 23cm/9"



**Heymann**  
 14-02175-18  
 18cm/7"



**Heymann**  
 14-02177-19  
 19.5cm/7 3/4"



**Knight**  
 14-02181-18  
 18cm/7"



**Fomon**  
 14-02185-13  
 13cm/5"



**Fomon**  
 14-02189-13  
 13.5cm/5 1/4"



**Fomon**  
 14-02191-13  
 13.5cm/5 1/4"



**Cottle**  
 14-02195-16  
 16cm/6 1/4"



**Halle**  
 14-02199-19  
 19cm/7 1/4"





14-02202-22 **Strully** 22cm/8 3/4" 14-02203-22



**Dandy**  
14-02207-22  
17cm/6 3/4"



Trigeminal Scissors

**Olivecrona**  
14-02211-15



**Universal**  
14-02215-12  
12cm/4 3/4"



**Goldman-Fox**  
Straight  
14-02218-13  
13cm/5"



**Goldman-Fox**  
Curved  
14-02219-13  
13cm/5"

*PinsmedTC*

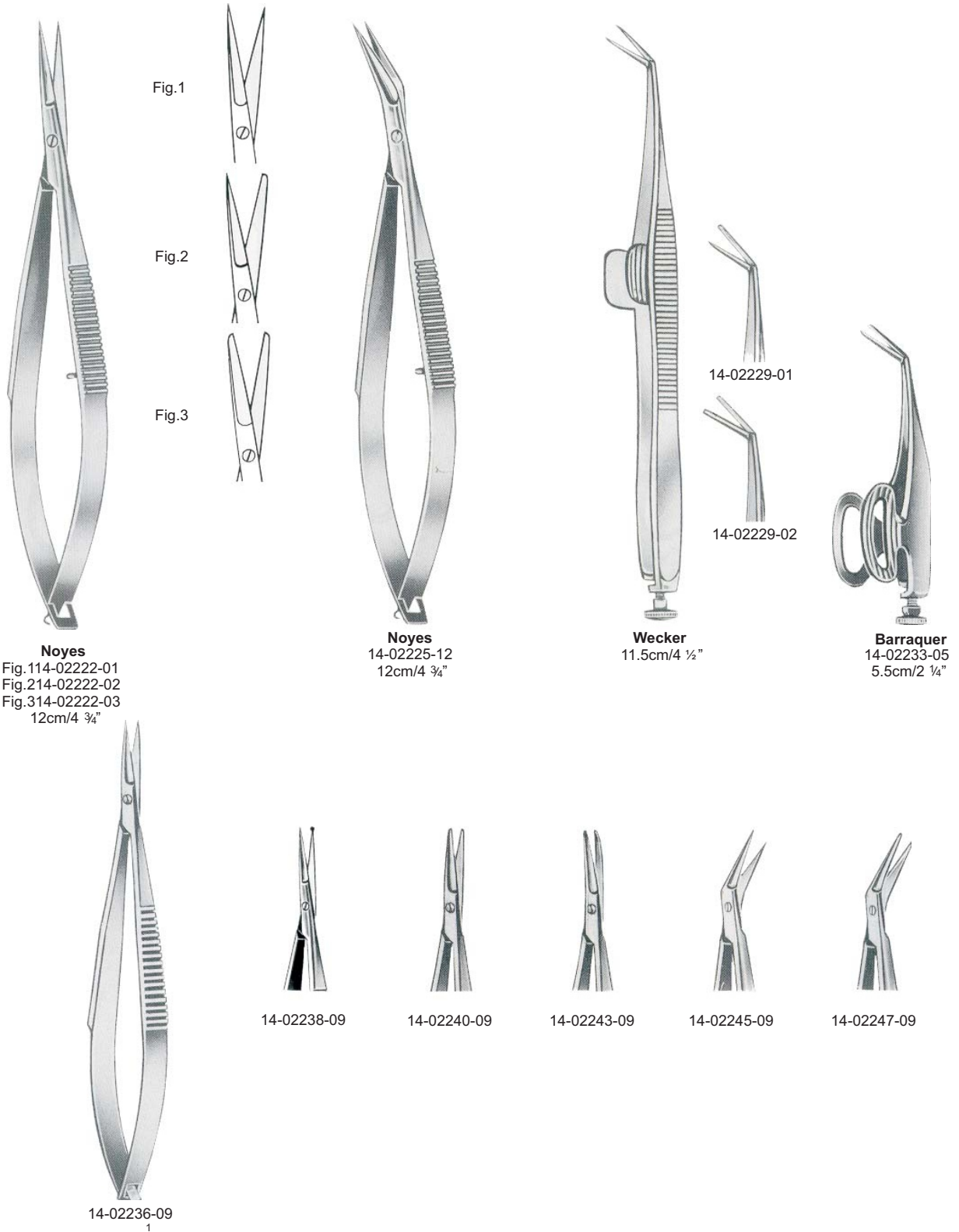

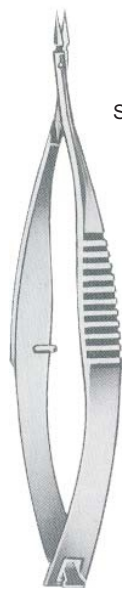

Straight

**Vannas**  
 14-02250-08  
 8cm/3 1/4"

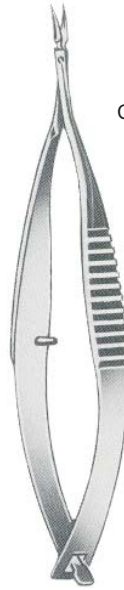

Curved

**Vannas**  
 14-02253-08  
 8cm/3 1/4"

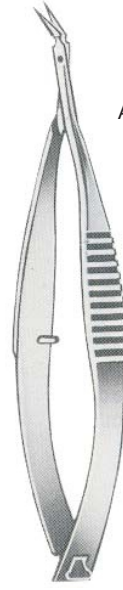

Angular

**Vannas**  
 14-02255-08  
 8cm/3 1/4"

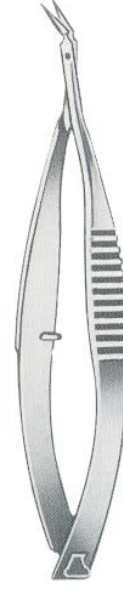

**Vannas**  
 14-02257-08  
 8cm/3 1/4"



Straight

14-02260-08  
 8.5cm/3 1/4"

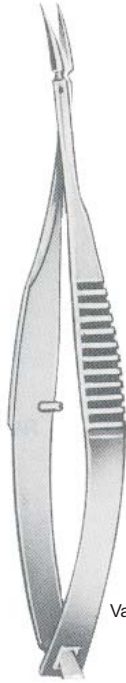

Curved

VannasMod, Tübingen

14-02263-08  
 8.5cm/3 1/2"

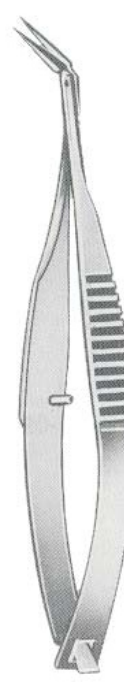

Angular

14-02265-08  
 8.5cm/3 1/2"

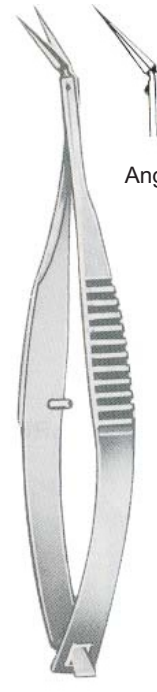

Angular

14-02267-08  
 8.5cm/3 1/2"



14-02270-10  
10cm/4"

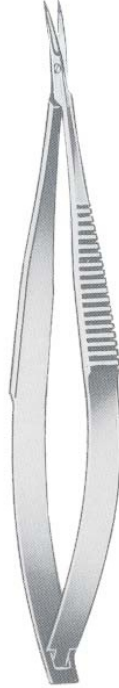

14-02271-10  
10cm/4"



**Castroviejo**  
14-02273-10  
10cm/4"



**Castroviejo**  
14-02275-10  
10cm/4"



**Aebli**  
14-02277-10  
10cm/4"



**Castroviejo**  
14-02281-10  
10cm/4"



**Castroviejo**  
14-02283-10  
10cm/4"

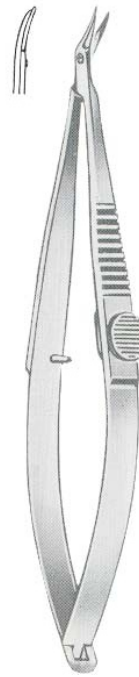

**Troutman-Barraquer**  
14-02285-10  
10cm/4"

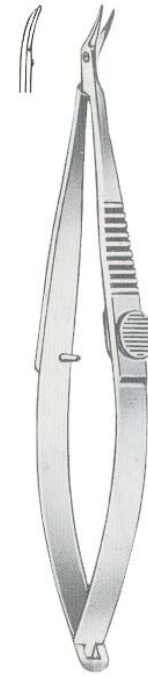

**Troutman-Barraquer**  
14-02287-10  
10cm/4"



**Troutman**  
 14-02291-10  
 10cm/4"

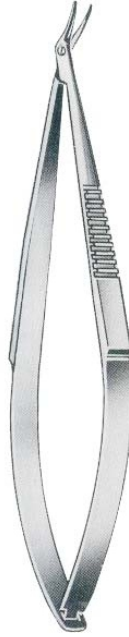

**Troutman**  
 14-02293-10  
 10cm/4"



**Katzin-Barraquer**  
 14-02295-10  
 10cm/4"

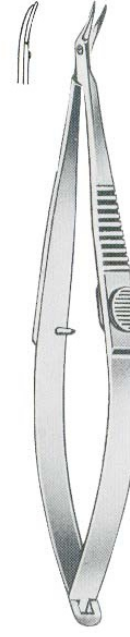

**Katzin-Barraquer**  
 14-02297-10  
 10cm/4"



**Katzin**  
 14-02301-11  
 10cm/4"

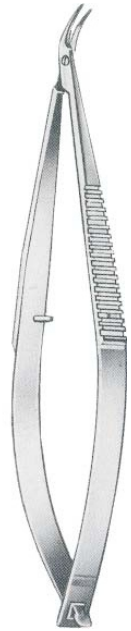

**Katzin**  
 14-02303-11  
 10cm/4"



**Westcott**  
 14-02307-11  
 11cm/4 1/2"



**Westcott**  
 14-02309-11  
 11cm/4 1/2"



**Westcott**  
 14-02311-11  
 11cm/4 1/2"





**Castroviejo**  
14-02315-10  
10cm/4"



**Castroviejo**  
14-02317-10  
10cm/4"



**Castroviejo**  
14-02321-11  
11.5cm/4 1/2"



**Castroviejo**  
14-02323-11  
11.5cm/4 1/2"



**Troutmann-Castroviejo**  
14-02327-10  
10.5cm/4 1/4"



**Troutmann-Castroviejo**  
14-02329-10  
10.5cm/4 1/4"



**Straight**  
14-02332-14  
14-02332-18

**Curved**  
14-02333-14  
14-02333-18

14.5cm/5 3/4"  
18.0cm/7"



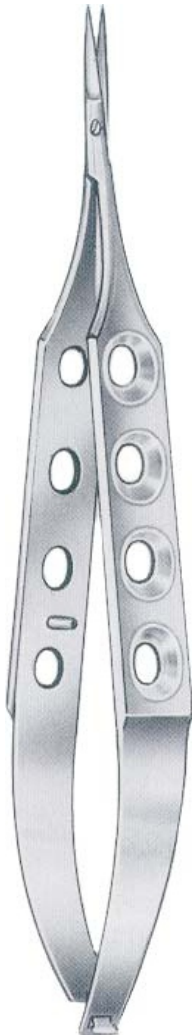

**Straight**

14-02336-12 12.0cm/4 3/4"  
 14-02336-16 16.0cm/6 1/4"  
 14-02336-18 18.5cm/7 1/4"



**Curved**

14-02337-12 12.0cm/4 3/4"  
 14-02337-16 16.0cm/6 1/4"  
 14-02337-18 18.5cm/7 1/4"



**Vannas  
Straight**

14-02340-12 12.0cm/4 3/4"  
 14-02340-16 16.0cm/6 1/4"



**Vannas  
Curved**

14-02341-12 12.0cm/4 3/4"  
 14-02341-16 16.0cm/6 1/4"



**Yasargil**

16.5cm/6½"  
 20.0cm/8"

20.0cm/8"

20.0cm/8"



**Straight**  
 14-02344-16  
 14-02344-20



**Curved**  
 14-02345-16  
 14-02345-20



**CurvedDownwards**  
 14-02347-20

**DissectingScissors**



**Straight**  
 14-02350-20



**Curved**  
 14-02351-20



Yasargil

22.5cm/9"



Straight  
 14-02354-22  
 14-02354-24



Curved  
 14-02355-22  
 14-02355-24



22.5cm/9"  
 CurvedDownwards  
 14-02357-22

DissectingScissors



Straight  
 14-02360-22



Curved  
 14-02361-22



**Jacobson**  
18cm/7"

14-02364-18



14-02370-19

14-02365-18



14-02371-19

14-02367-18



14-02373-19



14-02376-19



14-02377-19



19cm/7½"

chirurgische allgemeine Instrumente

Instrumental quirúrgicos general

Strumenti chirurgici generali

## VeinScissors

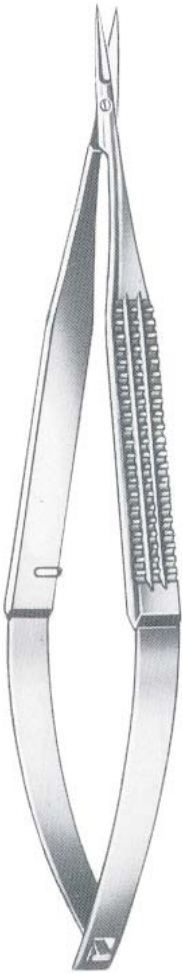

Straight  
14-02384-12  
12cm/4¾"



Curved  
14-02385-12  
12cm/4¾"



Straight  
14-02392-12  
12cm/4¾"

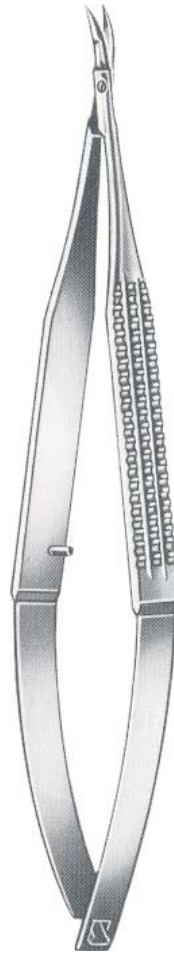

Curved  
14-02393-12  
12cm/4¾"

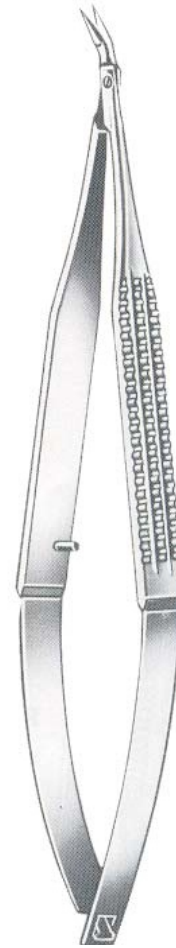

Angledup  
14-02395-12  
12cm/4¾"

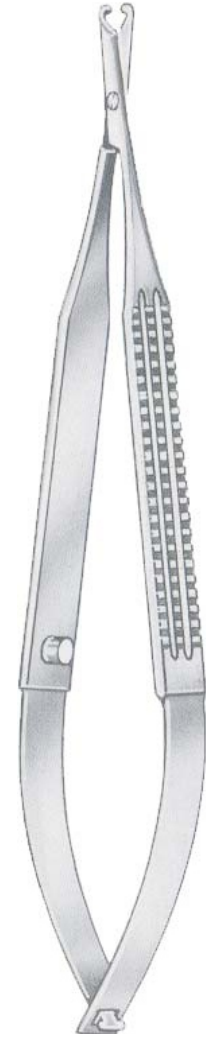

Straight  
14-02400-13  
13cm/5½"

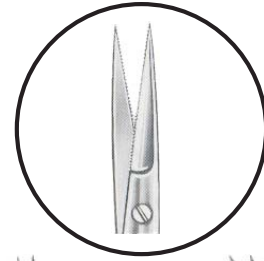

SawEdge

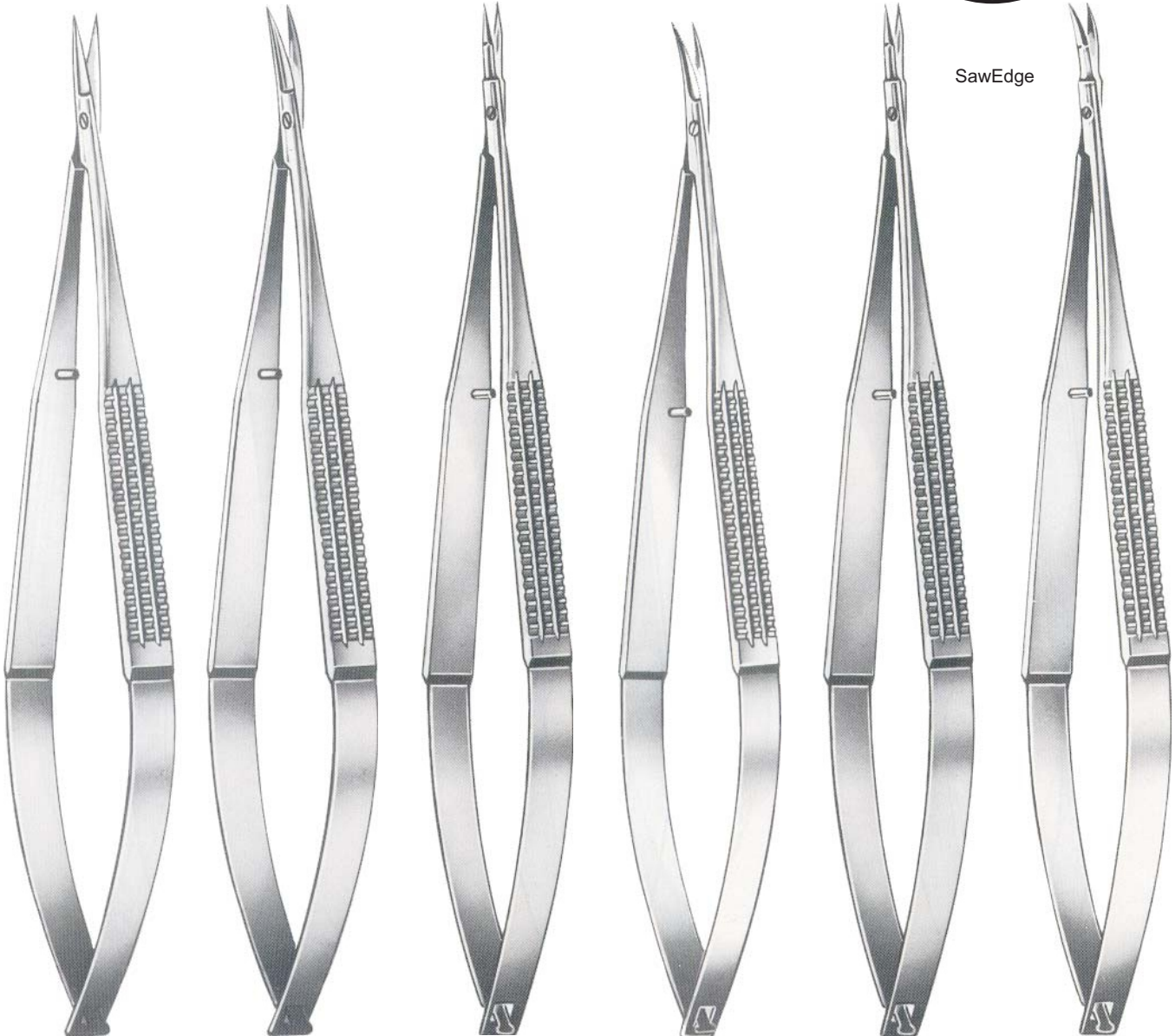

Straight  
14-02404-16  
16cm/6¼"

Curved  
14-02405-16  
16cm/6¼"

Straight  
14-02408-16  
16cm/6¼"

Curved  
14-02409-16  
16cm/6¼"

**Milled**  
Straight  
14-02412-16  
16cm/6¼"

**Milled**  
Curved  
14-02413-16  
16cm/6¼"





Straight  
14-02416-18  
18.5cm/7¼"



Curved  
14-02417-18  
18.5cm/7¼"



Angular  
14-02421-18  
18.5cm/7¼"

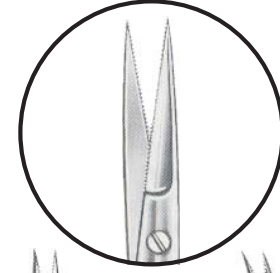

SawEdge



Straight  
 14-02424-16  
 16cm/6¼"



Curved  
 14-02425-16  
 16cm/6¼"



Straight  
 14-02428-16  
 16cm/6¼"



Curved  
 14-02429-16  
 16cm/6¼"



Straight  
 14-02432-16  
 16cm/6¼"



Curved  
 14-02433-16  
 16cm/6¼"



Straight  
14-02436-18  
18.5cm/7¼"



Curved  
14-02437-18  
18.5cm/7¼"



Angular  
14-02441-18  
18.5cm/7¼"



Straight  
14-02444-23  
23cm/9"

## Dissecting Scissors



Straight  
14-02448-14  
14.5cm/5¾"



Curved  
14-02449-14  
14.5cm/5¾"



Curved  
14-02451-14  
14.5cm/5¾"



## *PinsmedTC*







**Standard**

9.0 cm/3½"	14-02482-09	14-02483-09	14-02485-09	14-02487-09
10.5 cm/4¼"	14-02482-10	14-02483-10	14-02485-10	14-02487-10
11.5 cm/4½"	14-02482-11	14-02483-11	14-02485-11	14-02487-11



**Fine**

**Fine**

9.0cm/3¾"			14-02496-09	14-02497-09
10.5cm/4¼"	14-02492-10	14-02493-10	14-02496-10	14-02497-10
11.5cm/4½"	14-02492-11	14-02493-11	14-02496-11	14-02497-11





<sup>14</sup> Straight  
**Fine**

9.5 cm/3¾"	14-02500-09
10.5 cm/4 1/8"	14-02500-10
11.5 cm/4½"	14-02500-11



Curved  
**Fine**

14-02501-09
14-02501-10
14-02501-11



Straight

Curved

14-02504-10	10cm/4"	14-02505-10
-------------	---------	-------------

## Tenotomy Scissors



10.5cm/4¼"  
11.5cm/4½"



Pointed



Curved



Blunt



Curved

Straight
14-02508-10
14-02508-11

Curved
14-02509-10
14-02509-11

Straight
14-02512-10
14-02512-11

Curved
14-02513-10
14-02513-11

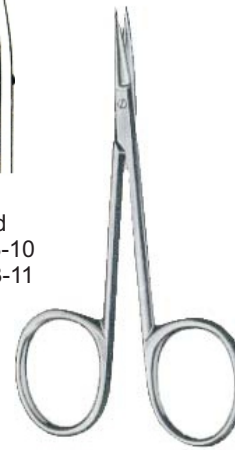

Straight  
14-02516-08



8cm/3¼"  
**Bonn**  
Curved  
14-02517-08



**Graefe**  
14-02520-10  
10.5cm/4¼"



**Wilmer**  
14-02521-10  
10cm/4"



14-02524-11

11.5cm/4½"



14-02525-11

## *PinsmedTC*



**Straight**  
14-02528-11

11.5cm/4½"



**Curved**  
14-02529-11

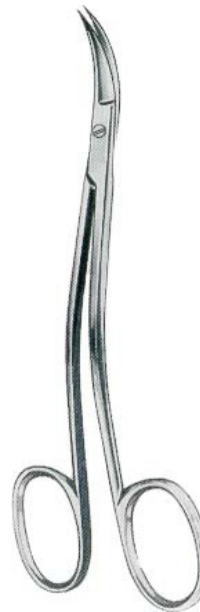

**LaGrange**  
14-02532-11  
11.5cm/4½"



**Chadwick**  
14-02533-11  
11cm/4½"

## Neurosurgical Scissors

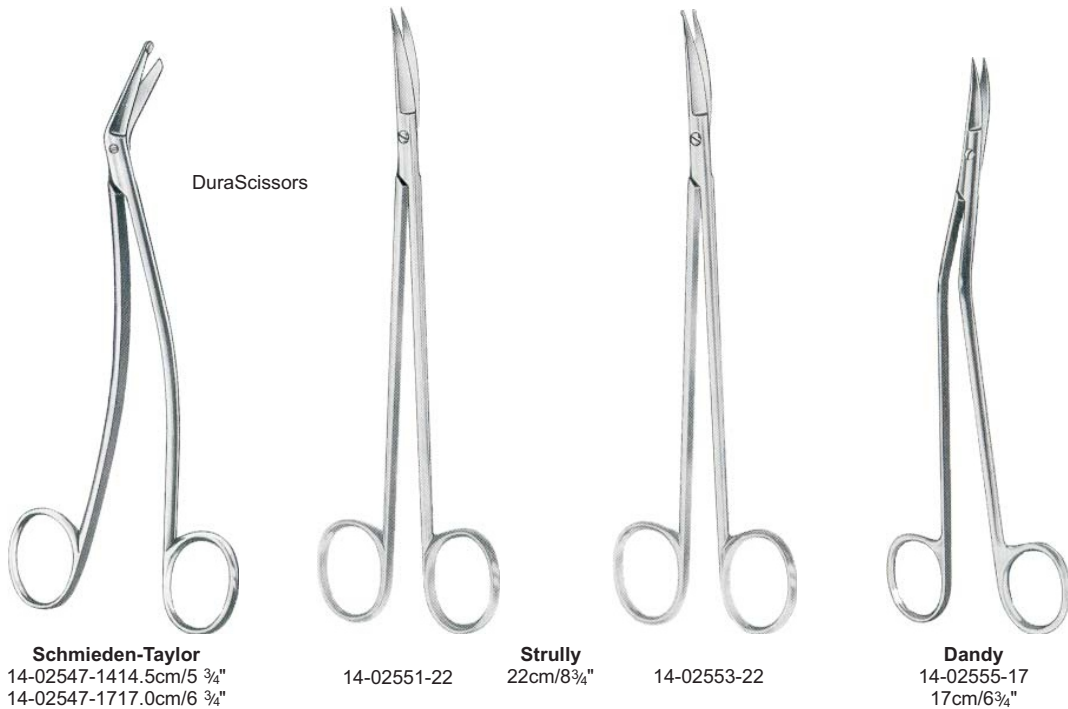
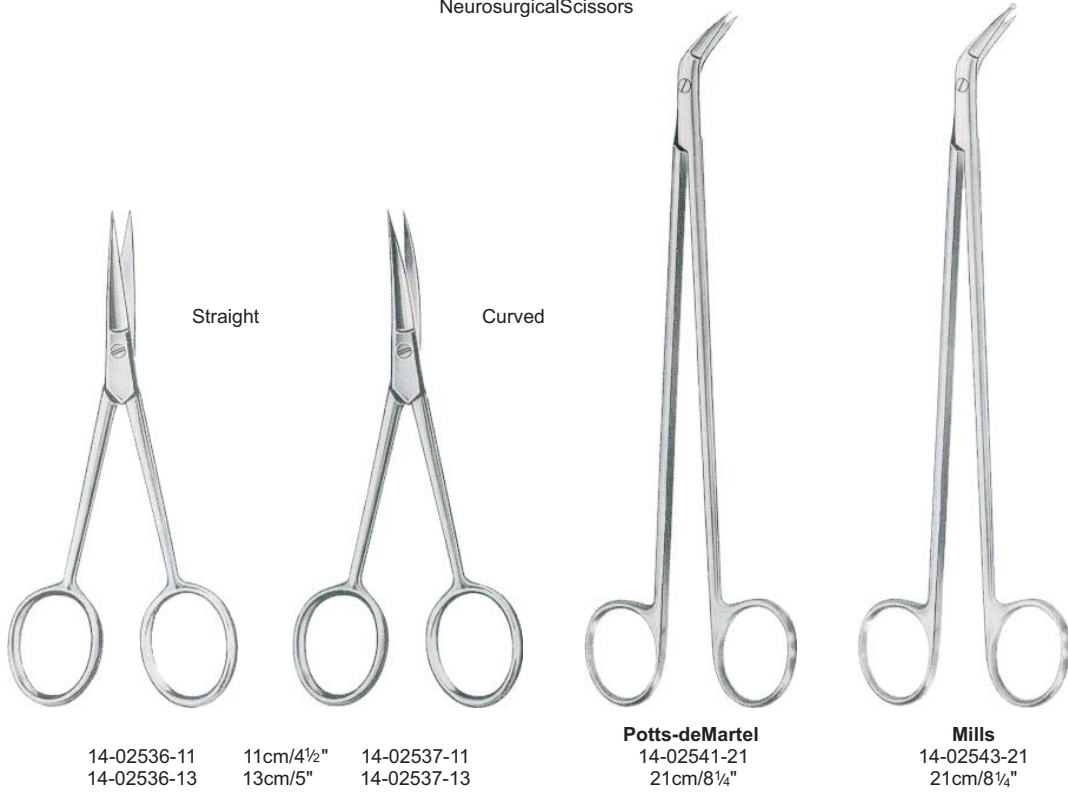



**Littauer**  
14-02559-14  
14cm/5"



**Spencer**  
14-02563-09  
9cm/3½"



**Spencer**  
14-02565-10 10.5cm/4¼"  
14-02565-12 12.0cm/4¾"



**Spencer-Fine**  
14-02567-11 11.5cm/4½"  
14-02567-16 16cm/6¼"



**Shortbent**  
14-02571-09  
9cm/3½"



**Northbent**  
14-02575-12  
12.5cm/5"



**Spencer**  
14-02579-11  
11.5cm/4½"



**Littler**  
14-02583-11  
11.5cm/4½"



**Heath**  
14-02587-15  
15cm/6"



14-02591-10  
10cm/4"



**Eiselsberg**  
14-02595-11  
11.5cm/4½"



WireCuttingScissors

**Schoemaker-Loth**  
14-02599-12  
12.5cm/5"



SawEdge

**Universal**  
14-02603-12  
12cm/4¾"

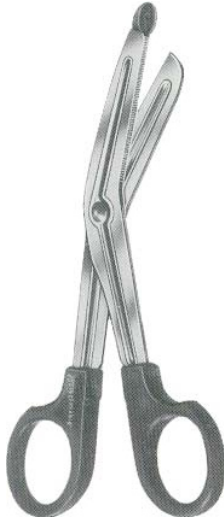

**Universal**

Black	14-02607-01
Blue	14-02607-02
Red	14-02607-03
Green	14-02607-04

14.5cm/5 3/4"



**Universal**

Black	14-02609-01
Blue	14-02609-02
Red	14-02609-03
Green	14-02609-04

16cm/6 1/4"



**Universal**

Black	14-02611-01
Blue	14-02611-02
Red	14-02611-03
Green	14-02611-04

18cm/7"



**Smith**

14-02615-17  
17.5cm/7"



Sawedge

**Harvey**

14-02618-12  
12.5cm/5"

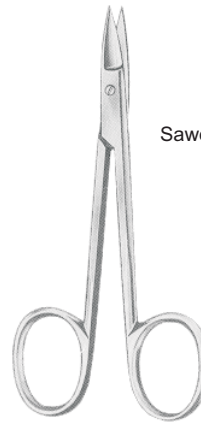

Sawedge

**Schuknecht**

14-02622-10  
10cm/4"

Nail Splinting Scissors



14-02626-13 13cm/5"  
14-02626-15 15cm/6"



## PinsmedTC



**Lister**

14-02629-09 09.0cm/3 1/2"  
 14-02629-11 11.5cm/4 1/2"  
 14-02629-14 14.0cm/5 1/2"  
 14-02629-15 15.5cm/6"  
 14-02629-18 18.0cm/7"  
 14-02629-20 20.0cm/8"



**Lister**

14-02631-18  
 18cm/7"



**Lister**

14-02633-18 18.5cm/7 1/4"  
 14-02633-21 21.0cm/8 1/4"



**Lister-Excentric**

14-02637-16 16cm/6 1/4"  
 14-02637-19 19cm/7 1/2"



**Esmarch**

14-02641-2020cm/8"  
 14-02641-2222cm/8 3/4"



**Bergmann**

14-02645-23  
 23cm/9"



**Lorenz**

14-02649-23  
 23cm/9"



Sawedge

14-02653-17  
 17cm/6 ¾"



**Lange**  
 14-02657-18  
 18cm/7"



**Bruns**  
 14-02661-2424cm/9 ½" Sawedge  
 14-02663-2424cm/9 ½" Smooth  
 14-02667-2424cm/9 ½" **PinsmedTC**

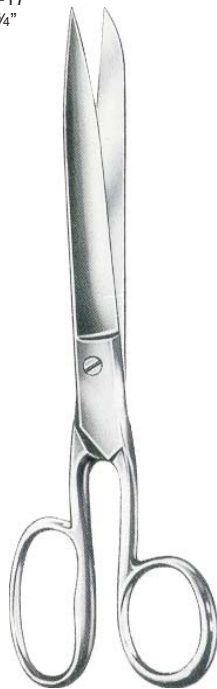

**Smith (Mod. USA)**  
 14-02671-18 18cm/7"  
 14-02671-20 20cm/8"  
 14-02671-23 23cm/9"

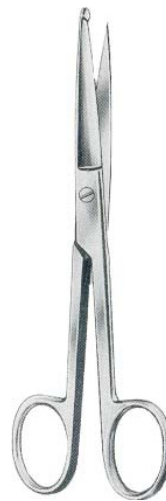

**Knowles**  
 14-02674-14  
 14cm/5 ½"



**Knowles**  
 14-02675-14  
 14cm/5 ½"



14-02679-13  
 13cm/5"



14-02683-20  
20cm/8"



**Seutin**  
14-02687-23  
23cm/9"



14-2691-23  
23cm/9"



**Collin**  
14-02695-22  
22cm/8 3/4"



**Gluck**  
14-02699-22  
22cm/8 3/4"



**Stille**  
14-02701-21  
21cm/8 1/4"



**Stille**  
14-02703-24  
24cm/9 1/2"



**Stille**  
14-02705-23 23cm/9"  
14-02705-26 26cm/10 1/4"  
14-02705-37 37cm/14 1/2"

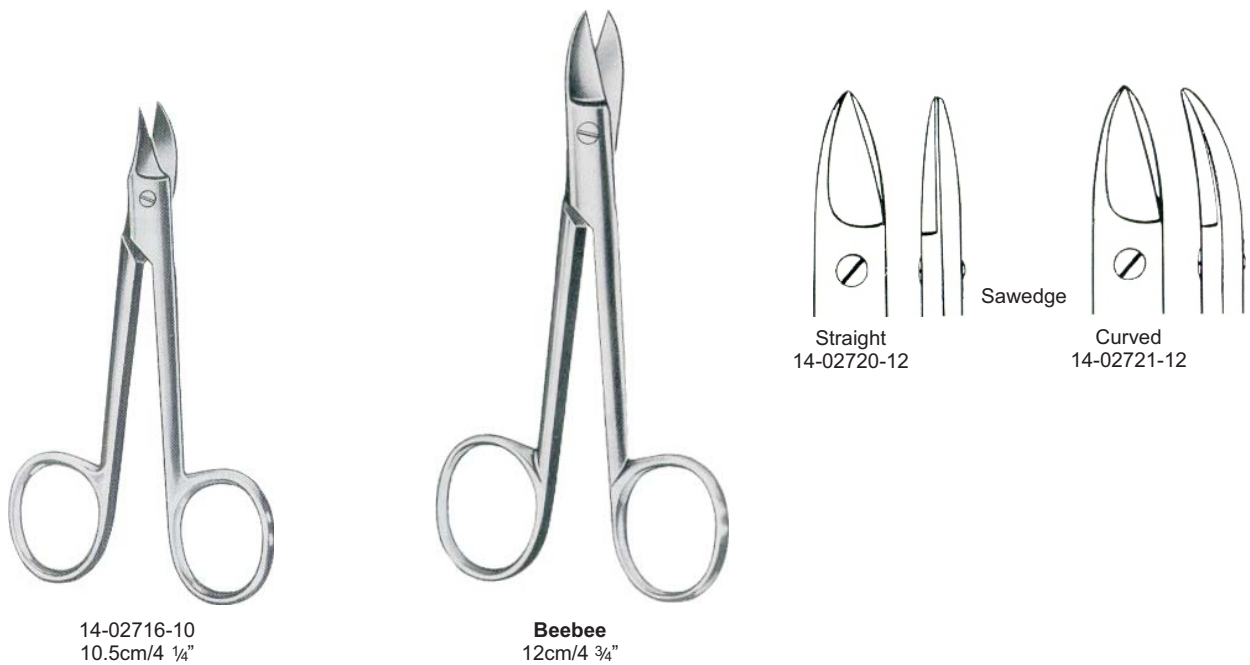
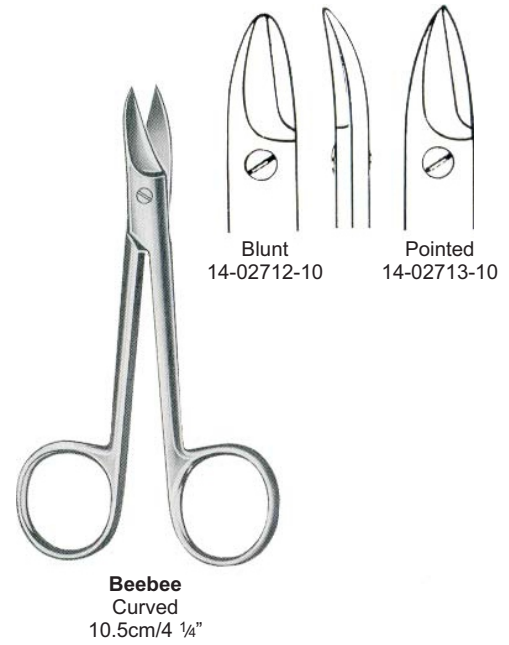



Sawedge

**Goldmann-Fox**  
14-02724-13  
13cm/5"



**Goldmann-Fox**  
14-02725-13  
13cm/5"



**Niro**  
14-02729-14  
14cm/5 1/2"



Sawedge

**Goldmann-Fox (Spezial)**  
14-02733-13  
13cm/5"



14-02737-11  
11.5cm/4 1/2"

Fine



**Quinby**  
14-02740-12  
12cm/4 3/4"



**Quinby**  
14-02741-12  
12cm/4 3/4"





Sawedge

**Dean**  
14-02745-17  
17cm/6 3/4"



**Dean**  
14-02747-17  
17cm/6 3/4"



Sawedge

**Locklin**  
14-02751-16  
16.5cm/6 1/2"



**Locklin**  
14-02753-16  
16.5cm/6 1/2"



Sawedge

**Sullivan**  
14-02758-14  
14.5cm/5 3/4"



**Sullivan**  
14-02759-14  
14.5cm/5 3/4"



**Neumann**  
14-02763-12  
12.5cm/5"



Sawedge

**LaGrange**  
14-02765-11  
11.5cm/4 1/2"





## Nailscissors



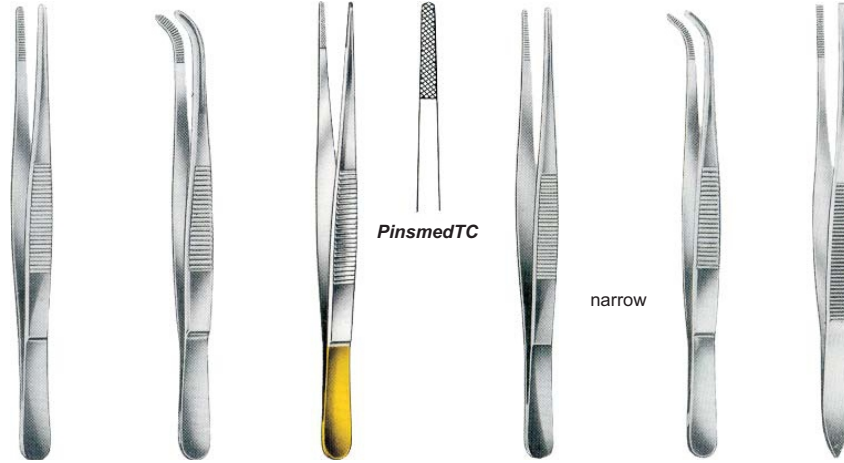

cm	in	Standard	Standard	Standard			Stille
10.5	4 1/4"	15-02788-10					
11.5	4 1/2"	15-02788-11	15-02789-11			15-02796-11	15-02797-11
13.0	5"	15-02788-13	15-02789-13			15-02796-13	15-02797-13
14.5	5 3/4"	15-02788-14	15-02789-14	15-02792-14		15-02796-14	15-02797-14
15.0	6"	15-02788-15					
16.0	6 1/4"	15-02788-16	15-02789-16	15-02792-16		15-02796-16	15-02797-16
17.0	6 3/4"						15-02802-17
18.0	7"	15-02788-18	15-02789-18	15-02792-18		15-02796-18	15-02797-18
20.0	8"	15-02788-20	15-02789-20	15-02792-20		15-02796-20	15-02797-20
25.0	10"	15-02788-25	15-02789-25	15-02792-25		15-02796-25	15-02797-25
30.0	12"	15-02788-30	15-02789-30			15-02796-30	15-02797-30

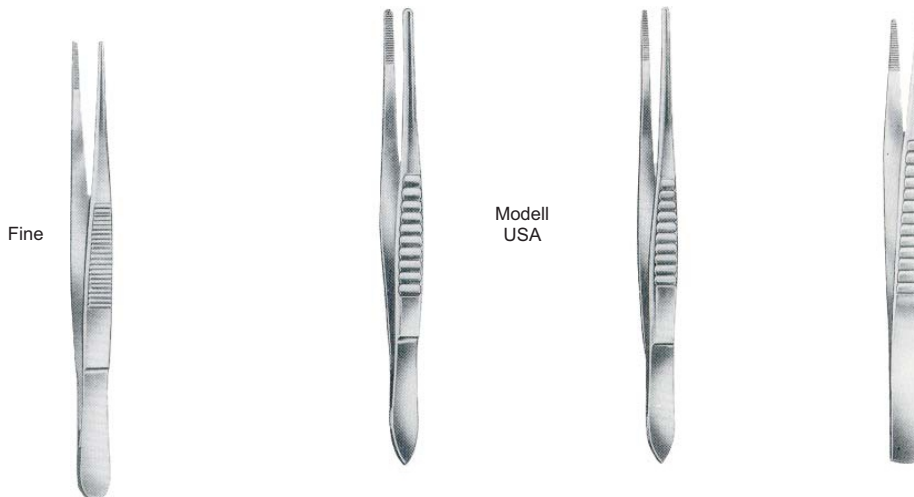

cm	in	Standard	Narrow	Engl.Modell
11.5	4 1/2"	15-02806-11		
12.0	4 3/4"		15-02810-12	
13.0	5"	15-02806-13	15-02810-13	15-02814-13
14.5	5 3/4"	15-02806-14	15-02810-14	15-02814-14
15.0	6"	15-02806-15	15-02810-15	15-02814-15
16.0	6 1/4"	15-02806-16		
18.0	7"	15-02806-18		
20.0	8"	15-02806-20		
21.0	8 1/4"		15-02810-21	
25.0	10"		15-02810-25	
30.0	12"		15-02810-30	



cm	in	Ewald	Jacobson-Adson	Micro-Adson	Adson-Standard	Adson
12.0	4¾"	15-02822-12	15-02826-12	15-02830-12	15-02834-12	15-02838-12
15.5	6"	15-02822-15	15-02826-15	15-02830-15	15-02834-15	15-02838-15

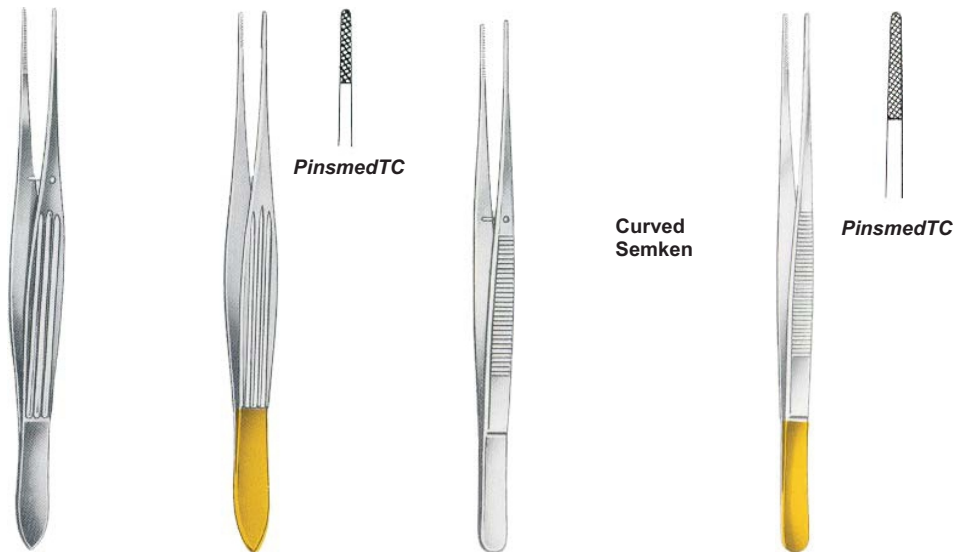

cm	in	McIndoe	McIndoe	Semken	Semken	Semken
12.0	4¾"			15-02848-12	15-02849-12	15-02852-12
15.0	6"	15-02842-15	15-02844-15	15-02848-15	15-02849-15	15-02852-15

With Dissector

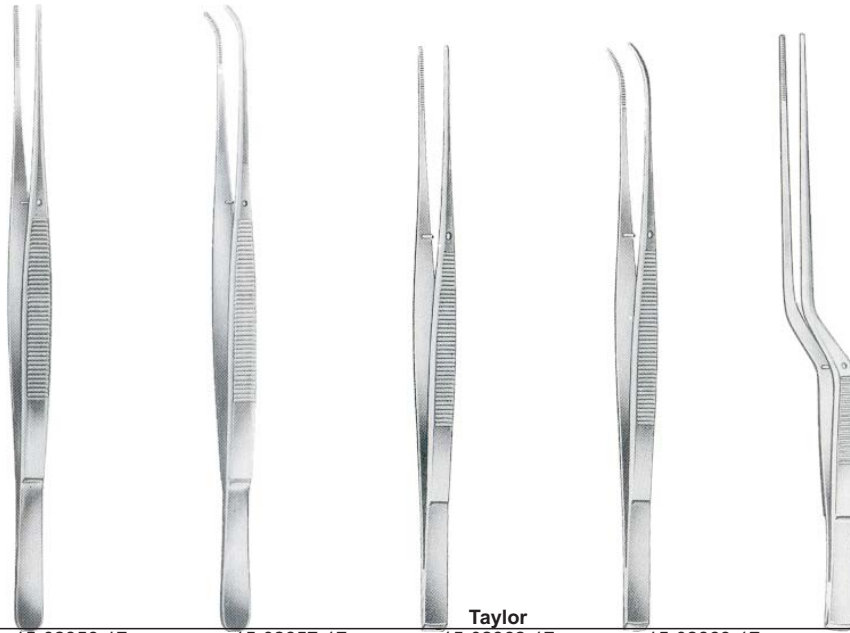

15-02856-17

15-02857-17

**Taylor**  
15-02862-17  
17.5cm/7"

15-02863-17

15-02867-17

Smooth Jaw



cm	in	Waugh		Bonney		Brophy	Brophy
15.0	6"	15-02870-15					
18.0	7"	15-02870-18	15-02874-18		15-02882-18		
20.0	8"	15-02870-20	15-02874-20	15-02878-20		15-02886-18	15-02887-18

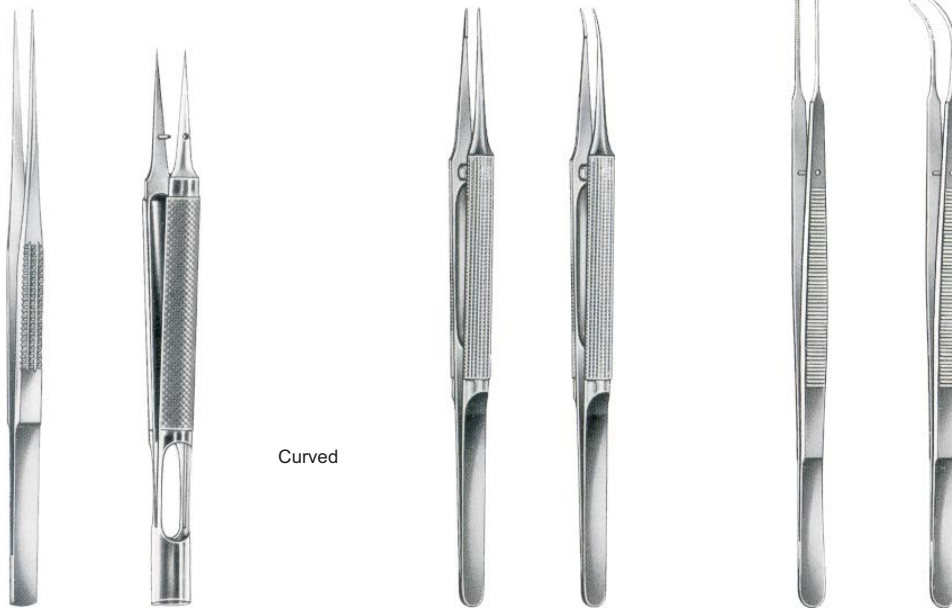

Curved

Gerald

cm	in						
12.0	4¾"			15-02898-12	15-02899-12		
13.0	5"	15-02894-13	15-02895-13				
15.0	6"	15-02890-15		15-02898-15	15-02899-15		
17.5	7"					15-02902-17	15-02903-17
18.0	7"	15-02890-18		15-02898-18	15-02899-18		

MicroTubalForceps



**Austin**  
 15-02906-14  
 14cm/5½"

**Austin**  
 15-02908-18  
 18cm/7"

**Neubuser**  
 15-02912-20  
 20cm/8"

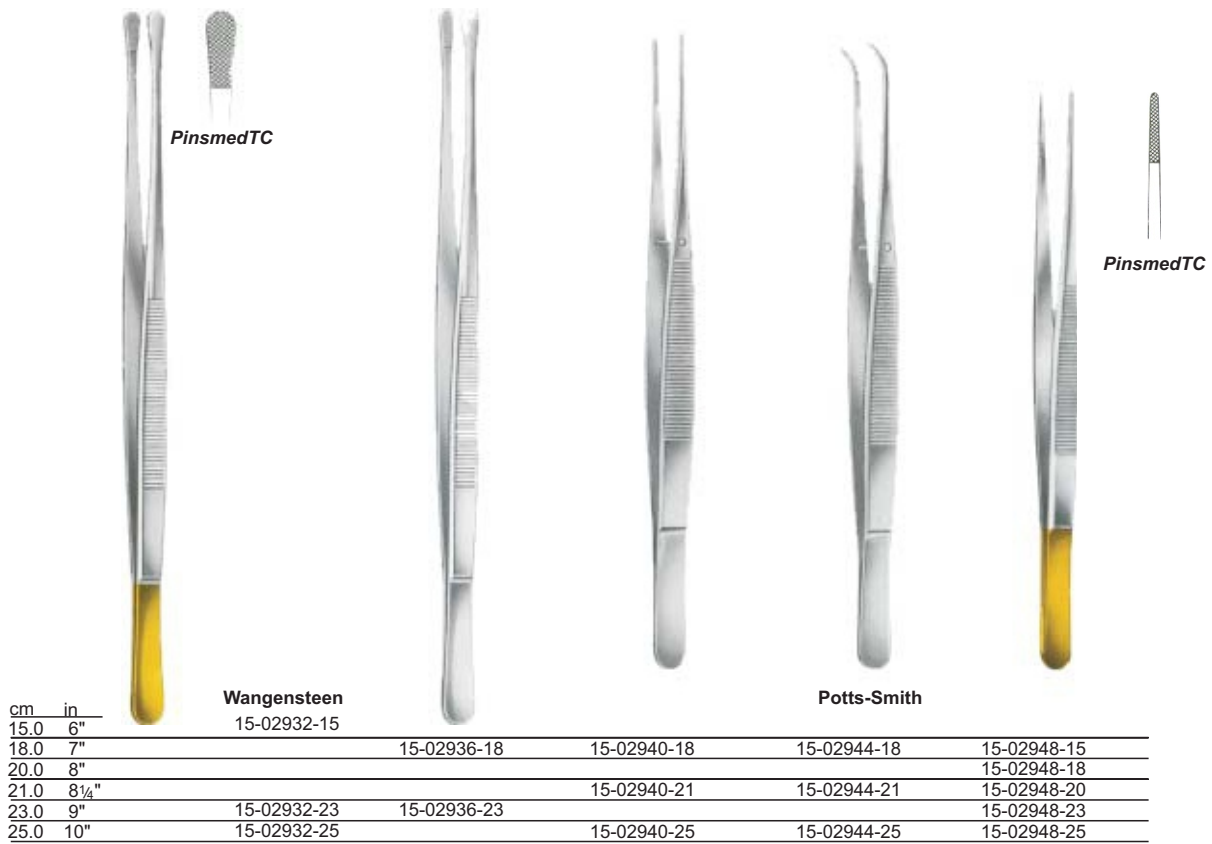
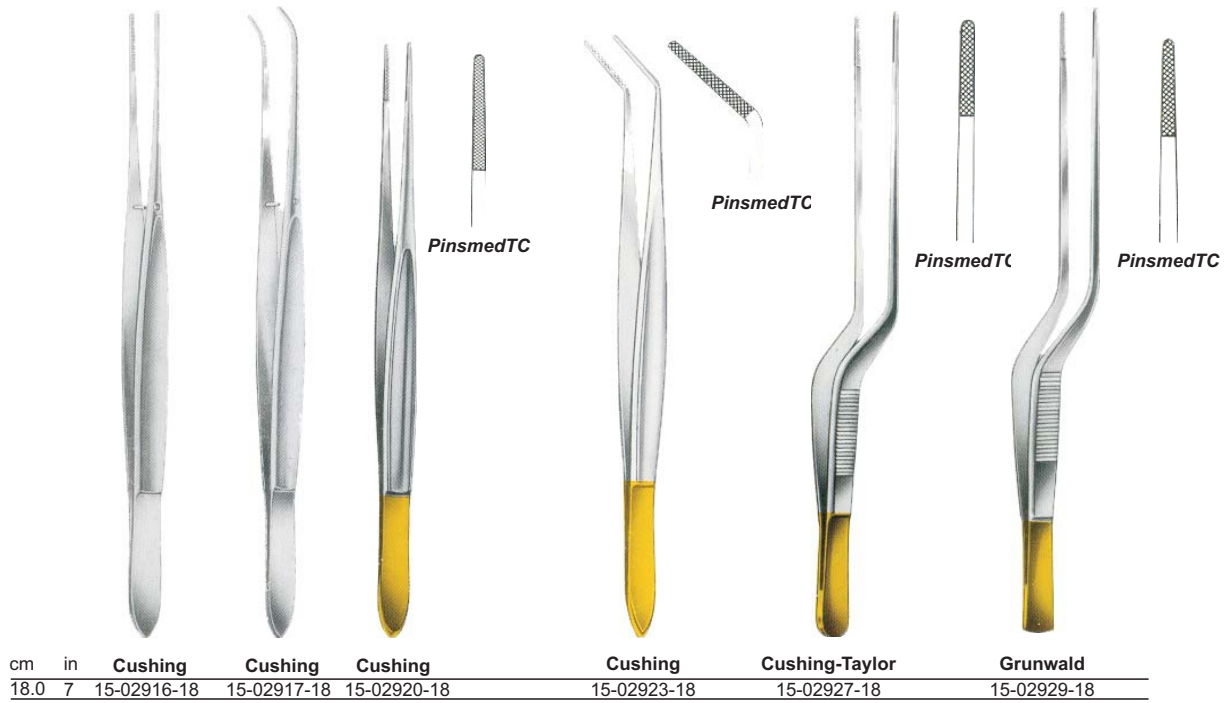





cm	in	Standard 1:2	Oehler 1:2	Standard 2:3	Standard 3:4	Standard 4:5	1:2
10.5	4 ¼"	15-02952-10					
11.5	4 ½"	15-02952-11					
13.0	5"	15-02952-13		15-02960-13	15-02964-13	15-02968-13	15-02972-13
14.5	5 ¾"	15-02952-14	15-02956-14	15-02960-14	15-02964-14	15-02968-14	15-02972-14
15.0	6"	15-02952-15					
16.0	6 ¼"	15-02952-16	15-02956-16	15-02960-16	15-02964-16	15-02968-16	15-02972-16
18.0	7"	15-02952-18	15-02956-18	15-02960-18			15-02972-18
20.0	8"	15-02952-20	15-02956-20	15-02960-20			15-02972-20
25.0	10"	15-02952-25	15-02956-25	15-02960-25			15-02972-25
30.0	12"	15-02952-30	15-02956-30	15-02960-30			

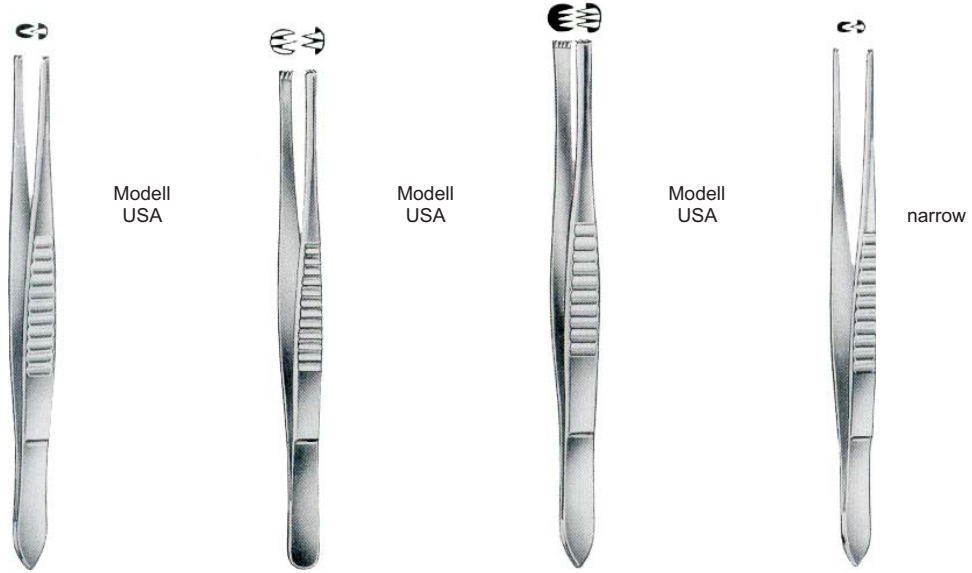

Standard

cm	in	1:2	2:3	3:4	1:2
12.0	4 <sup>3</sup> / <sub>4</sub> "	15-02976-12	15-02980-12		
13.0	5"	15-02976-13	15-02980-13		15-02988-13
14.5	5 <sup>3</sup> / <sub>4</sub> "	15-02976-14	15-02980-14	15-02984-14	15-02988-14
15.5	6"	15-02976-15			15-02988-15
18.5	7 <sup>1</sup> / <sub>4</sub> "	15-02976-18	15-02980-18		
21.0	8 <sup>1</sup> / <sub>4</sub> "	15-02976-21	15-02980-21		
25.0	10"	15-02976-25	15-02980-25		
31.0	12 <sup>1</sup> / <sub>4</sub> "	15-02976-31	15-02980-31		



cm	in	Lerche	Stone	Treves
13.0	5"			15-03000-13
15.0	6"	15-02992-15	15-02996-15	15-03000-15

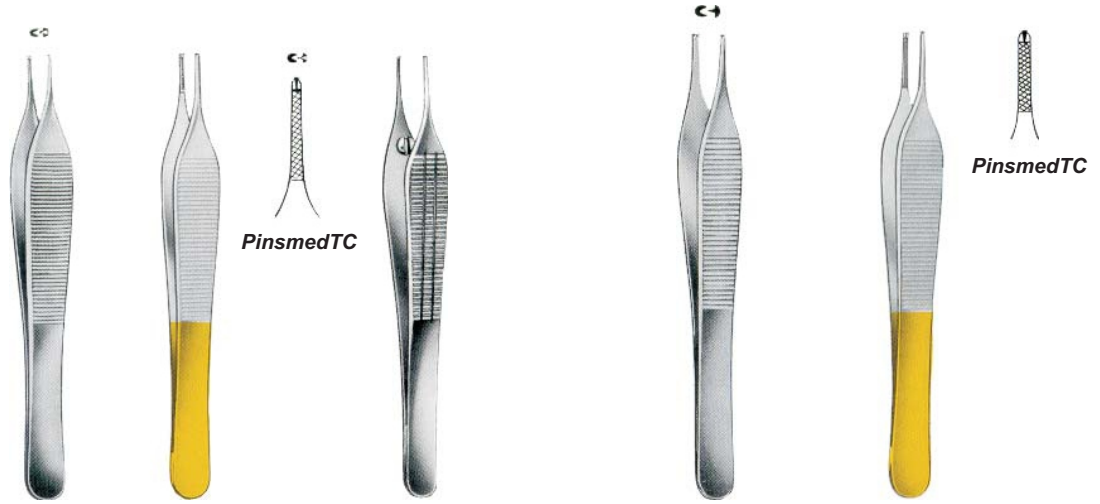

cm	in	Micro-Adson			Ewald	Standard-Adson
12.0	4¾"	15-03004-12	15-03008-12	15-03012-12	15-03016-12	15-03020-12
15.5	6"	15-03004-15	15-03008-15	15-03012-15		15-03020-15

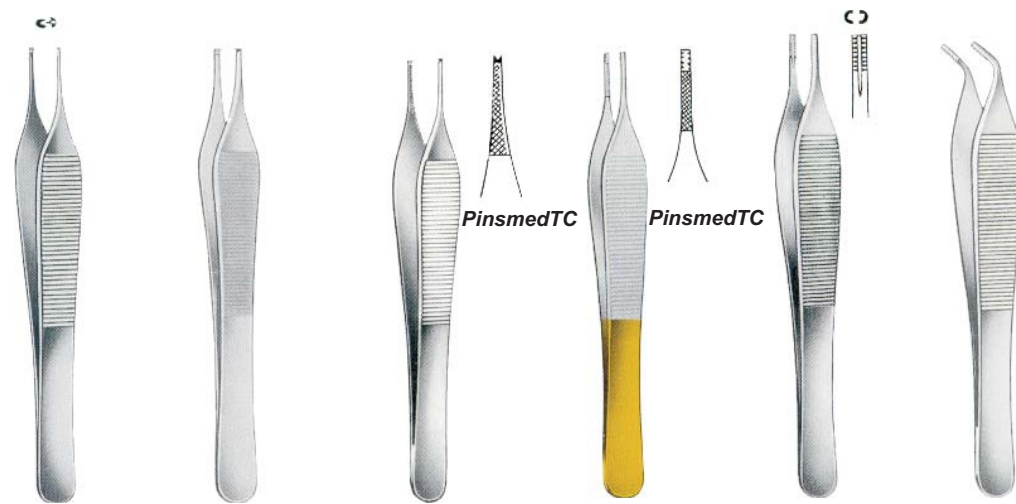

cm	in	Adson				Adson-Brown	
12.0	4¾"	15-03024-12	15-03028-12	15-03032-12	15-03036-12	15-03040-12	15-03041-12
15.0	6"	15-03024-15	15-03028-15				



**Gillies**  
15-03046-15  
15cm/6"



**Gillies**  
15-03050-15  
15cm/6"



**Brown**  
15-03054-15 15cm/6"  
15-03054-20 20cm/8"  
15-03054-25 25cm/10"



**Semken**  
15-03058-12 12cm/4"  
15-03058-15 15cm/6"  
3/4" 15-03062-12  
15-03062-15



**Adlerkreutz**  
15-03066-15 15cm/6"  
15-03066-20 20cm/8"  
15-03066-25 25cm/10"



**Adlerkreutz**  
15-03070-15 15cm/6"  
15-03070-20 20cm/8"  
15-03070-25 25cm/10"



**Taylor**  
15-03074-17  
17.5cm/7"



**Taylor**  
15-03075-17  
17.5cm/7"



**Taylor**  
15-03078-17  
17.5cm/7"



**Taylor**  
15-03079-17  
17.5cm/7"



cm	in	Waugh	Brophy	Brophy	Gerald	Gerald
15	6"	15-03082-15				
18	7"	15-03082-18			15-03092-18	15-03093-18
20	8"	15-03082-20	15-03086-20	15-03087-20		



**Cushing**  
15-03096-18  
17.5cm/7"



**Cushing**  
15-03097-18  
17.5cm/7"



**Potts-Smith**



15-04000-18  
15-04000-21  
15-04000-25

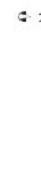

18cm/7"  
21cm/8 1/4"  
25cm/10"



15-04001-18  
15-04001-21  
15-04001-25



**Duval**  
15-04004-14 14.5cm/5 3/4"



**Collin-Duval**  
15-04008-20 20cm/8"

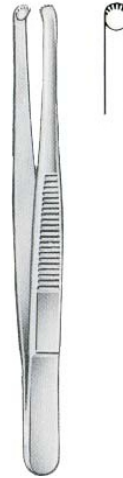

**Durante**  
15-04012-14 14.5cm/5 3/4"  
15-04012-16 16.0cm/6 1/4"  
15-04012-20 20.0cm/8"



**Russ Modell**  
15-04016-15 15cm/6"  
15-04016-20 20cm/8"  
15-04016-25 25cm/10"



**Mayo**  
15-04020-23 23cm/9"



**Ferris-Smith**  
18cm/7"



15-04022-18

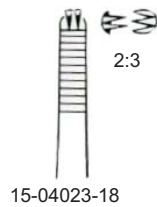

15-04023-18



**Lane**  
15-04026-14 14.5cm/5 3/4"  
15-04026-20 20.0cm/8"  
15-04028-14  
15-04028-20





## Grasping Forceps

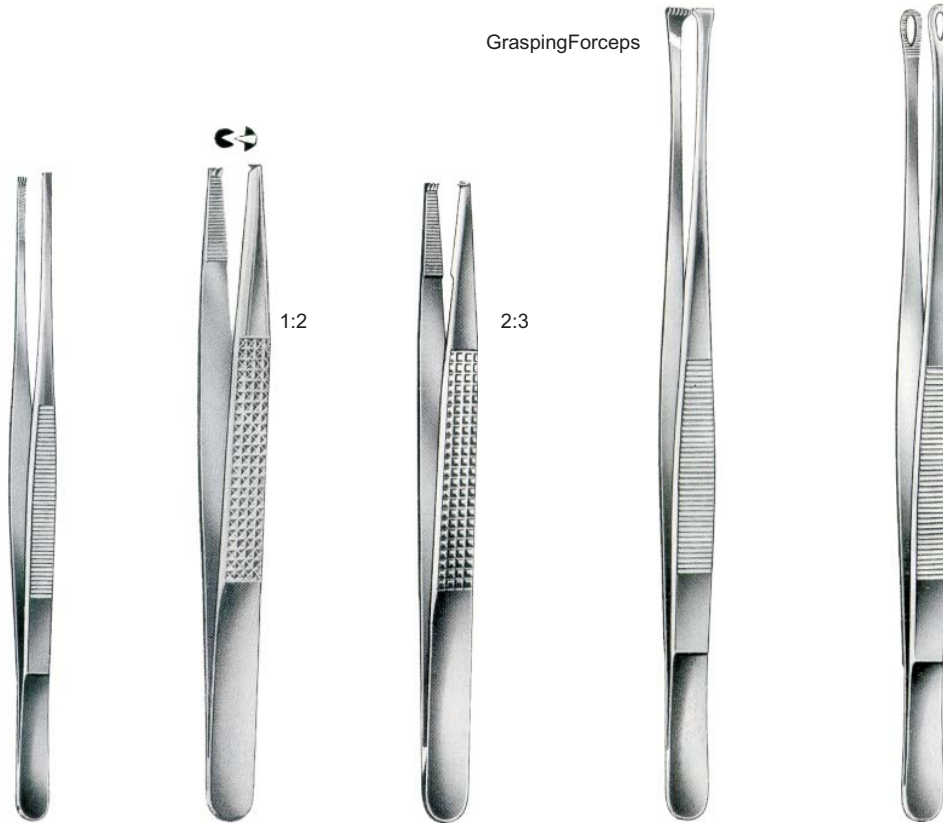

cm	in	Stille-Barraya	Bonney	Bonney	Nelson	Singley-Tuttle
15.0	6"				15-04042-15	
18.0	7"	15-04032-18	15-04036-18	15-04038-18	15-04042-18	15-04046-18
20.0	8"	15-04032-20			15-04042-23	
23.0	9"					15-04046-23
25.0	10"	15-04032-25				

## Watchmaker's Forceps

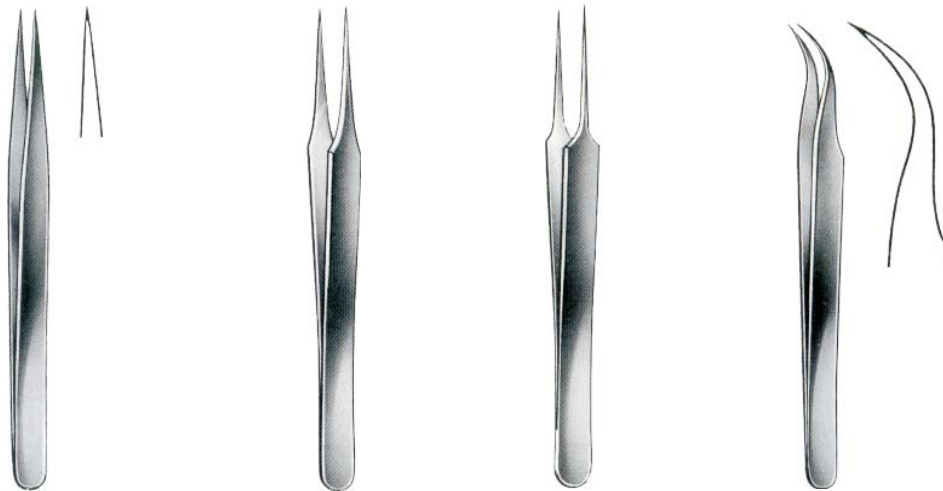

No.3  
15-04050-03  
11.5cm/4½"

No.4  
15-04050-04  
11.5cm/4½"

No.5  
15-04050-05  
11.5cm/4½"

No.7  
15-04050-07  
11.5cm/4½"



cm	in					
10.5	4 1/4"	15-04054-10	15-04055-10	15-04057-10	15-04060-10	15-04061-10

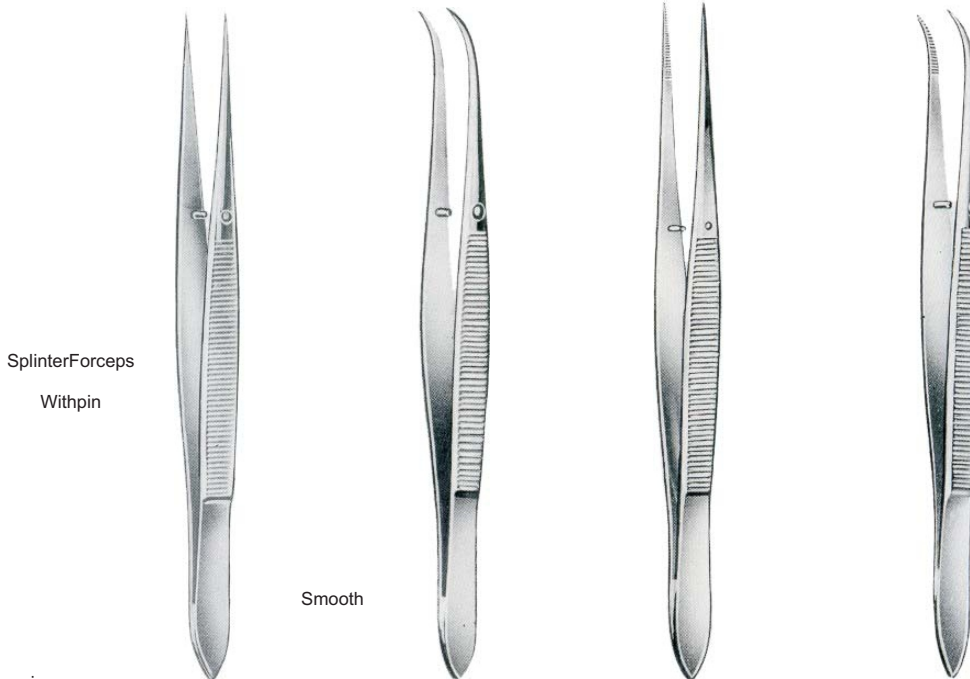

cm	in				
9.0	3 1/2"	15-04066-09	15-04067-09	15-04070-09	15-04071-09
10.5	4 1/4"	15-04066-10	15-04067-10	15-04070-10	15-04071-10
11.5	4 1/2"	15-04066-11	15-04067-11	15-04070-11	15-04071-11
12.5	5"	15-04066-12	15-04067-12	15-04070-12	15-04071-12



**Feilchenfeld**  
 15-04074-07 7.5cm/3"  
 15-04074-09 9.0cm/3½"  
 15-04074-11 11.5cm/4½"



15-04078-10



**Hunter**  
 10.5cm/4¼" 15-04079-10



15-04082-10



**Walter-Carmalt**  
 10.5cm/4¼" 15-04083-10



**Peet**  
 15-04087-11  
 11.5cm/4½"



**Stieglitz**  
 13.5cm/5¼"

Without Ratchet

15-04090-13



With Ratchet

15-04094-13



**Ralk**  
 15-04098-15  
 15cm/6"



**Ralk**  
 15-04099-15  
 15cm/6"

## Ligature Forceps



**Ochsner**  
15-04102-14  
14.5cm/5¾"



**Adson**  
15-04106-12  
12cm/4¾"

1:2



**Adson**  
15-04108-12  
12cm/4¾"

## Cilia Forceps



**Beaupre**  
15-04111-12  
12cm/4¾"



**Henry**  
15-04115-12  
12cm/4¾"



**Gradle**  
15-04118-09  
9.5cm/3¾"



**Barraquer**  
15-04121-10  
10.5cm/4¼"



**Bennett**  
15-04124-07  
7cm/2¾"



cm	in	Beer	Douglas	Ziegler	
8.0	3 1/4"	15-04128-08			
9.0	3 1/2"	15-04128-09	15-04132-09	15-04136-09	15-04140-09



**Kuehne**  
 15-04144-10  
 10.5cm/4 1/4"

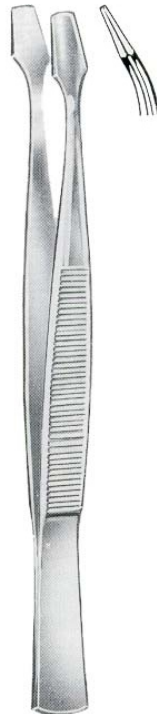

**Kuehne**  
 15-04145-10  
 10.5cm/4 1/4"



15-04148-10  
 10.5cm/4 1/4"



### Atrauma

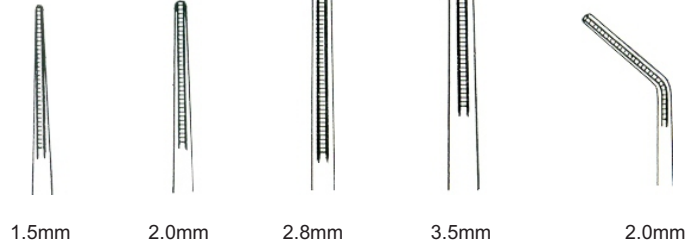

cm	in	1.5mm	2.0mm	2.8mm	3.5mm	2.0mm
16.0	6¼"	15-04154-16	15-04156-16	15-04158-16	15-04160-16	15-04161-16
20.0	8"	15-04154-20	15-04156-20	15-04158-20	15-04160-20	15-04161-20
24.0	9½"	15-04154-24	15-04156-24	15-04158-24	15-04160-24	15-04161-24
30.0	12"	15-04154-30	15-04156-30	15-04158-30	15-04160-30	15-04161-30



**Adson**  
15-04164-12 12cm/4 ¾"  
15-04164-15 15cm/6"



cm	in	Troeltsch (Wilde)	Troeltsch	Lucae	Lucae	Jansen (Gruenwald)	Jansen
11.5	4½"	15-04167-11					
12.0	4¾"	15-04167-12	15-04171-12	15-04175-14	15-04177-14		
14.0	5½"						
15.0	6"	15-04167-15					
16.0	6¼"					15-04181-16	15-04183-16
18.0	7"	15-04167-18				15-04181-18	15-04183-18
20.0	8"					15-04181-20	15-04183-20



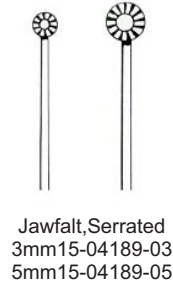
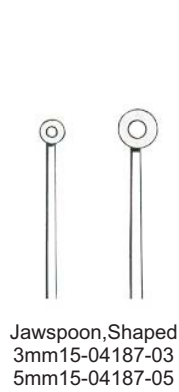

**Yasargil**  
22cm/8½"



15cm/6"	15-04194-16	15-04196-16		
18cm/7"			15-04198-18	15-04200-18
22cm/8¾"	15-04194-22	15-04196-22	15-04198-22	15-04200-22



Yasargil

22cm/8¾"  
 24cm/9½"

∅ 3mm  
 15-04203-22  
 15-04203-24

∅ 5mm  
 15-04205-22  
 15-04205-24

∅ 7mm  
 15-04207-24

22cm/8¾"

∅ 3mm  
 15-04209-22

∅ 3mm  
 15-04211-22

∅ 5mm  
 15-04213-22

∅ 5mm  
 15-04215-22  
 22cm/8¾"



160mm/6 " "  
 18cm/7"  
 20cm/8"  
 22cm/8¾"  
 24cm/9½"

0.6mm  
 15-04219-16  
 15-04219-18  
 15-04219-20  
 15-04219-22  
 15-04219-24

0.9mm  
 15-04221-16  
 15-04221-18  
 15-04221-20  
 15-04221-22  
 15-04221-24

15-04223-18  
 18cm/7"

**Yasargil**



**Dieffenbach**  
16-04226-03  
3.5cm/1½"  
16-04226-05  
5cm/2"



**Dieffenbach**  
16-04227-03  
3.5cm/1½"  
16-04227-05  
5cm/2"

Straight

For Bulldog Clamps

- 16-04234-0138mm/1 ½"
- 16-04234-0251mm/2"
- 16-04234-0357mm/2 ¼"
- 16-04234-0463mm/2 ½"
- 16-04234-0570mm/2 ¾"
- 16-04234-0675mm/3"
- 16-04234-0790mm/3 ½"



**Johns-Hopkins**

Curved

- 16-04235-0138mm/1 ½"
- 16-04235-0251mm/2"
- 16-04235-0357mm/2 ¼"
- 16-04235-0463mm/2 ½"
- 16-04235-0570mm/2 ¾"
- 16-04235-0675mm/3"
- 16-04235-0790mm/3 ½"



**Johns-Hopkins**  
16-04237-24  
24.5cm/9¾"



**Dieffenbach**  
16-04230-06  
6cm/2½"



**Dieffenbach**  
16-04231-06  
6cm/2½"

Haemorrhoidal Clamps



**Carrel**  
16-04240-10  
10cm/4"



**Chaput**  
16-04242-13  
13cm/5"

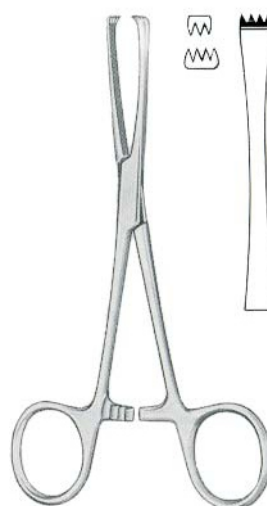

**Tuffier**  
16-04246-13  
13cm/5"



**Pratt**  
16-04250-15  
15cm/6"



**Terrier**  
16-04254-10 10cm/4"



**Pennington**  
16-04258-15 15cm/6"  
16-04558-20 20cm/8"



**Peau**  
16-04262-12 12.5cm/5"

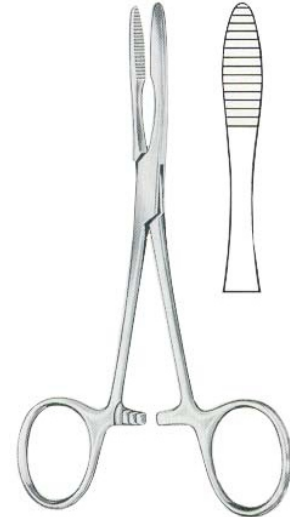

**Peau**  
16-04266-14 14cm/5 3/4"  
16-04566-16 16cm/6 1/4"

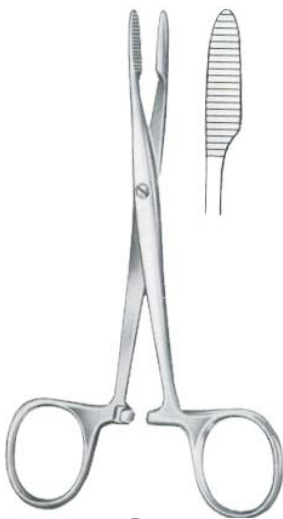

**Peau**  
16-04270-14 14cm/5 1/2"

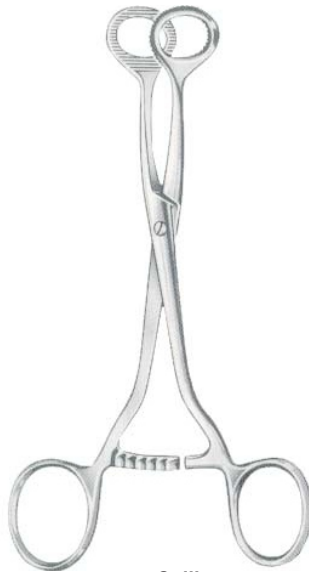

**Collin**  
16-04274-15 15.5cm/6"



**Collin**  
16-04278-14 14cm/5 1/2"



**Collin**  
16-04282-16 16.5cm/6 1/2"



**Hartmann**  
10cm/4"



16-04286-10



16-04290-10



16-04287-10



16-04291-10



**Halstead-Mosquito**  
12cm/4 3/4"  
14cm/5 1/2"



16-04294-12  
16-04294-14



16-04295-12  
16-04295-14



16-04298-12  
16-04298-14



16-04299-12  
16-04299-14



**Micro-Mosquito**  
10cm/4"  
12cm/4 3/4"



16-04302-10  
16-04302-12



16-04303-10  
16-04303-12



16-04306-10  
16-04306-12



16-04307-10  
16-04307-12



**Jacobson-Halstead**  
13cm/5"



16-04310-13



16-04311-13



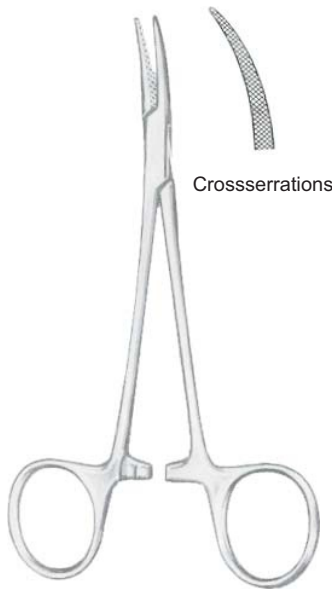

Crossserrations

16-04315-12  
12cm/4 3/4"



**Halstead-Mosquito**  
18cm/7"  
21cm/8 1/4"



16-04318-18  
16-04318-21



16-04319-18  
16-04319-21



16-04322-18  
16-04322-21

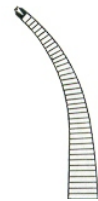

16-04323-18  
16-04323-21



**Kelly**  
14cm/5 1/2"

**Kelly-Rankin**  
16cm/6 1/4"



16-04326-14



14cm/5 1/2" 16-04327-14



16-04330-16



16cm/6 1/4" 16-04331-16



**Crile**  
14cm/5 1/2"

**Crile-Rankin**  
16cm/6 1/4"

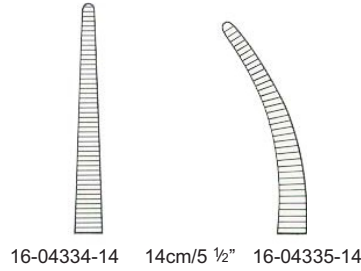

16-04334-14 14cm/5 1/2" 16-04335-14

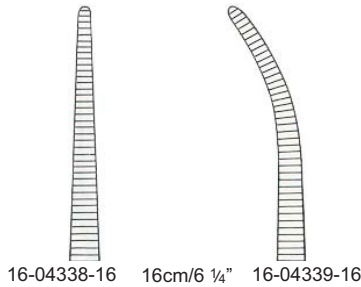

16-04338-16 16cm/6 1/4" 16-04339-16



**Baby-Crile**  
14cm/5 1/2"

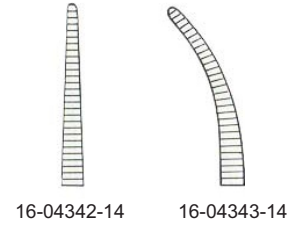

16-04342-14 16-04343-14



**Crile**  
14cm/5 1/2"

**Crile-Rankin**  
16cm/6 1/4"

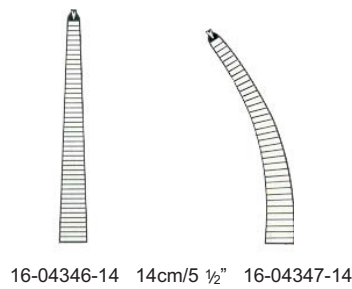

16-04346-14 14cm/5 1/2" 16-04347-14

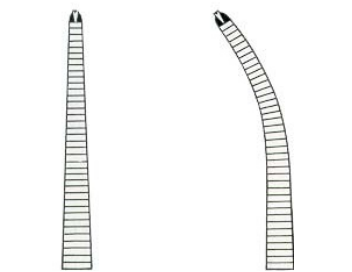

16-04350-16 16cm/6 1/4" 16-04351-16



**Baby-Crile**  
14cm/5 1/2"

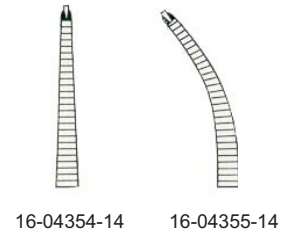

16-04354-14 16-04355-14



**Coller-Crile**

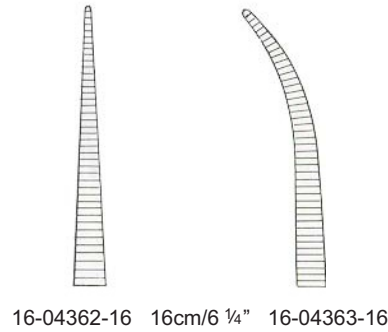
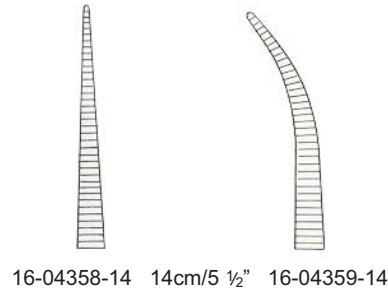

**Coller-Crile**  
16-04367-16  
16cm/6 1/4"



**Leriche**  
15cm/6"

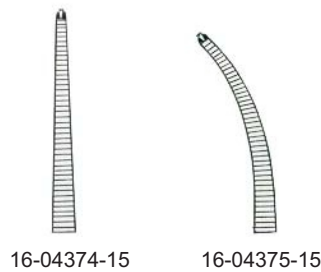
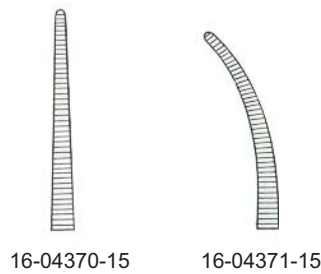

**Providence**  
14cm/5 1/2"



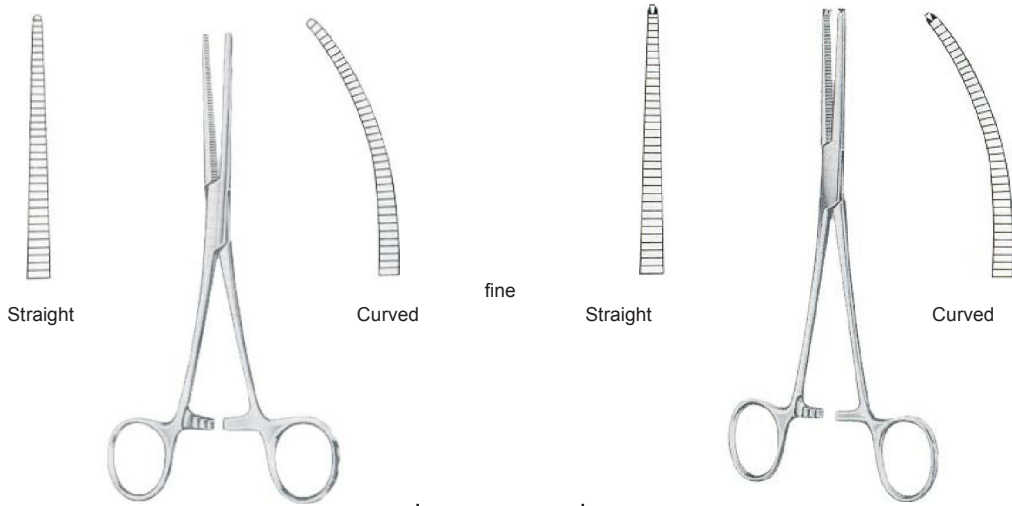

Rochester-Pean		cm	in	Ochsner-Kocher	
16-04382-13	16-04383-13	13.0	5"	16-04386-13	16-04387-13
16-04382-14	16-04383-14	14.0	5 1/2"	16-04386-14	16-04387-14
16-04382-16	16-04383-16	16.0	6 1/4"	16-04386-16	16-04387-16

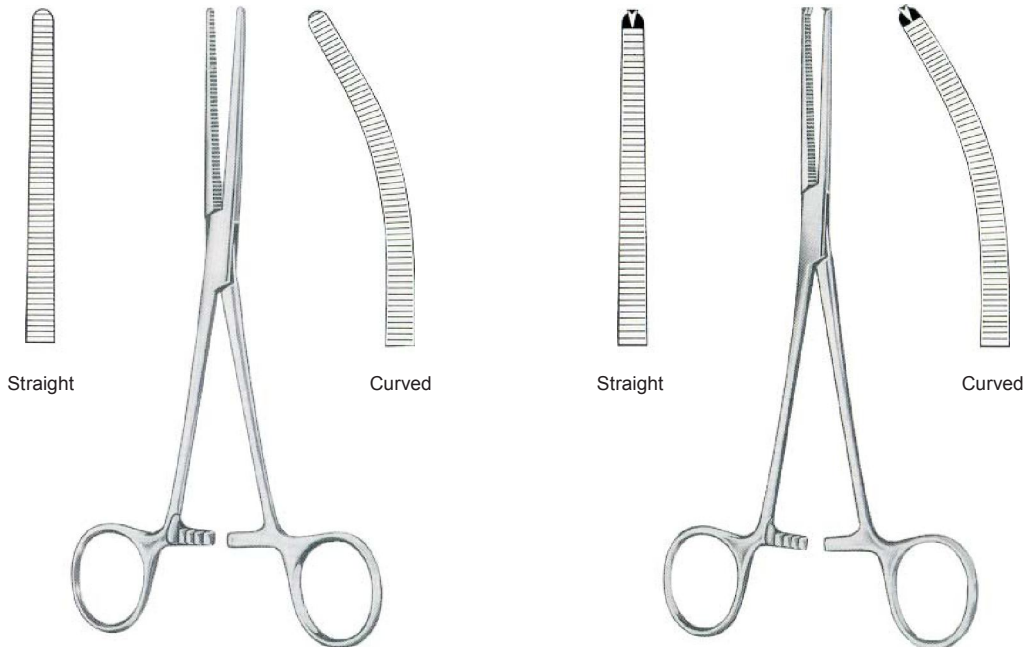

Rochester-Pean		cm	in	Ochsner-Kocher	
16-04390-13	16-04391-13	13.0	5"	16-04394-13	16-04395-13
16-04390-14	16-04391-14	14.0	5 1/2"	16-04394-14	16-04395-14
16-04390-16	16-04391-16	16.0	6 1/4"	16-04394-16	16-04395-16
16-04390-18	16-04391-18	18.0	7"	16-04394-18	16-04395-18
16-04390-20	16-04391-20	20.0	8"	16-04394-20	16-04395-20
16-04390-22	16-04391-22	22.0	8 3/4"	16-04394-22	16-04395-22
16-04390-24	16-04391-24	24.0	9 1/2"	16-04394-24	16-04395-24
16-04390-26	16-04391-26	26.0	10 1/4"	16-04394-26	16-04395-26
16-04390-30	16-04391-30	30.0	12"	16-04394-30	16-04395-30



Tendon Seizing Forceps

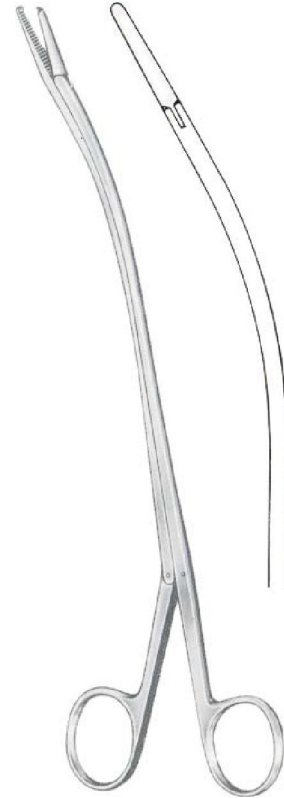

**Brand**  
16-04403-1515cm/6"  
16-04403-1919cm/7 1/2"  
16-04403-2424cm/9 1/2"

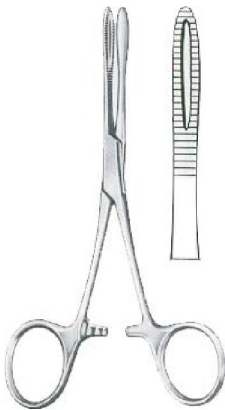

**Kronlein**  
16-04398-13  
13cm/5"

**Brand**  
16-04402-1515cm/6"  
16-04402-1919cm/7 1/2"  
16-04402-2424cm/9 1/2"

Lateral Curved

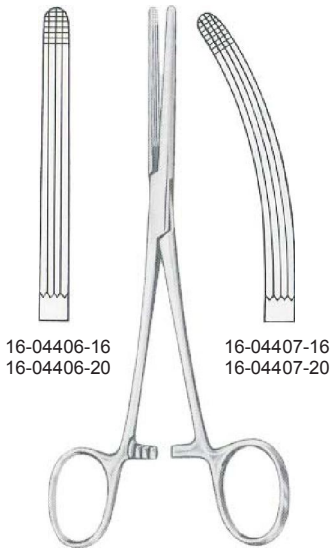

16-04406-16  
16-04406-20

16-04407-16  
16-04407-20

**Rochester-Carmalt**  
16cm/6 1/4"  
20cm/8"



16-04410-12

**Mosquito-Dandy**  
12cm/4 3/4"

16-04412-12



16-04415-14

**Dandy**  
14cm/5 1/2" 16-04416-14



**Lovelace**  
16-04420-15  
15.5cm/6"



**Dixon-Lovelace**  
16-04424-16  
16cm/6¼"



**Dixon-Lovelace**  
16-04426-16  
16cm/6¼"

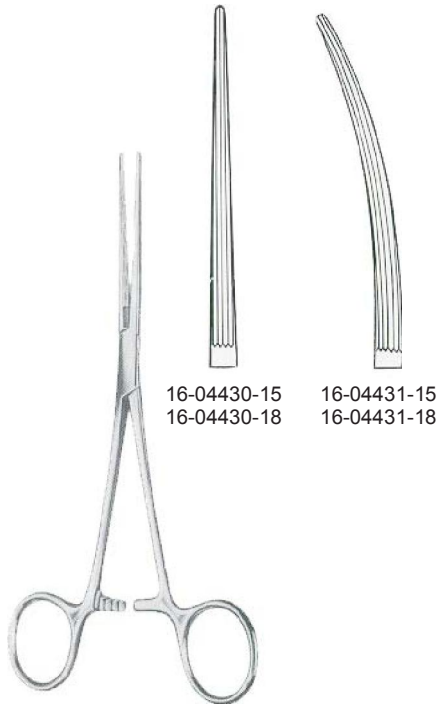

**Bainbridge**  
15cm/6"  
18cm/7"

16-04430-15  
16-04430-18

16-04431-15  
16-04431-18



**Fuchsig**  
16-04435-19  
19cm/7½"





**Adson**  
18.5cm/7¼"



16-04438-18



16-04439-18



16-04442-18



16-04443-18



**Nissen**  
16-04446-18 18.5cm/7 ¼"  
16-04446-22 22.0cm/8¾"



**Baby-Adson**



16-04449-14  
14cm/5½"



16-04451-18  
18cm/7"



**Jacobson-Adson**  
18cm/7"

VeryFine



16-04454-18



16-04455-18

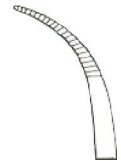

16-04457-18

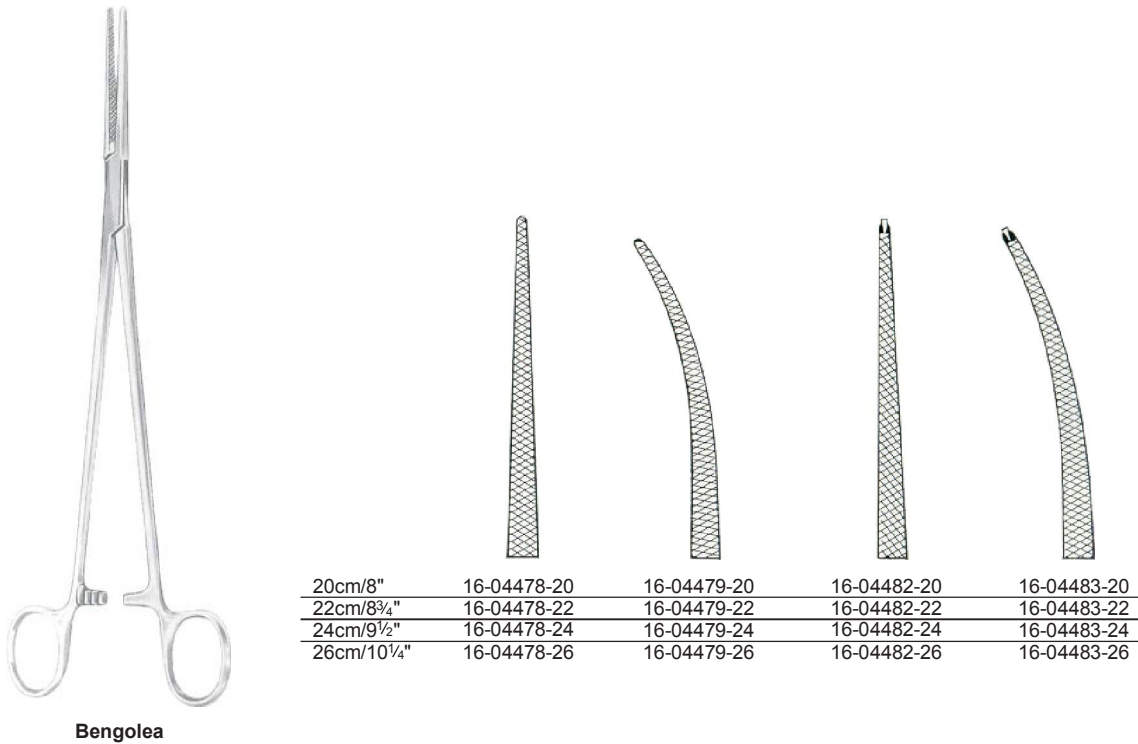
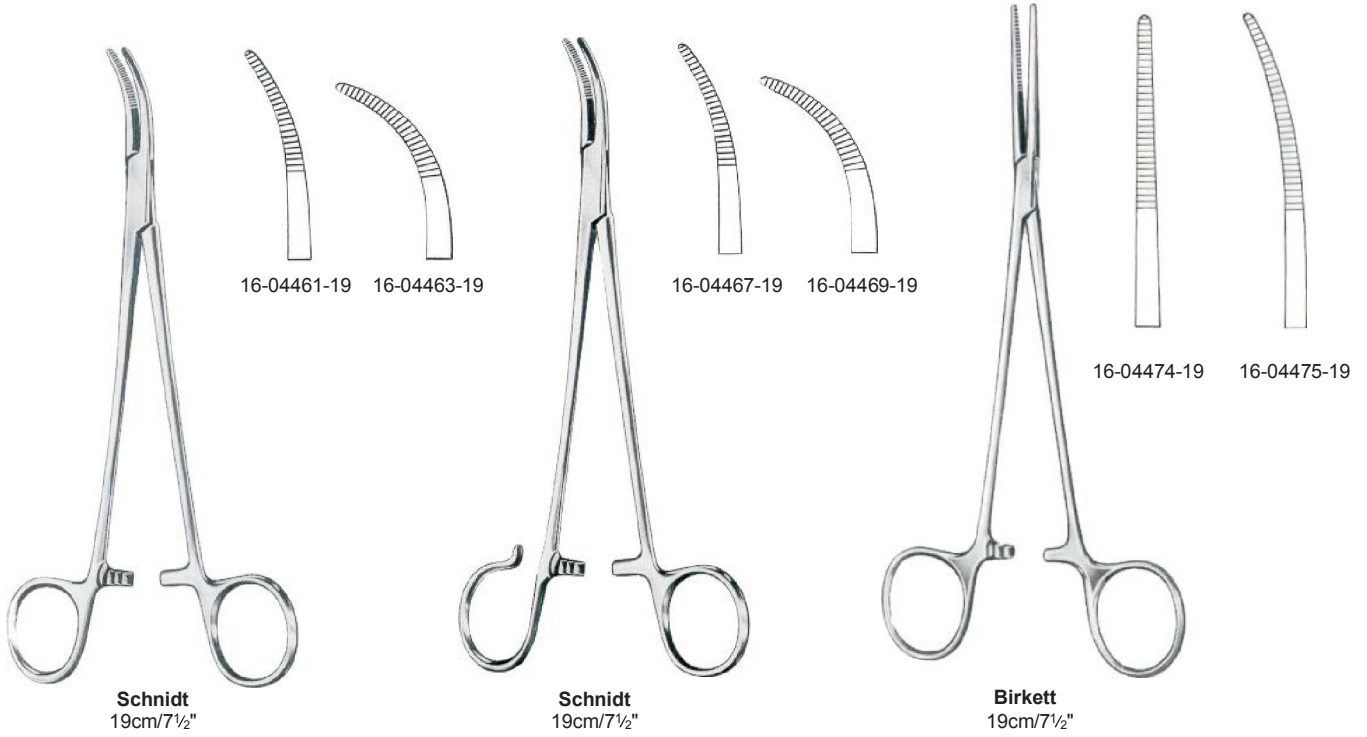



16-04486-27



16-04487-27

**Bridge**  
27cm/10½"



16-04490-22

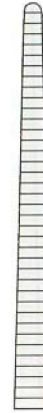

16-04491-22

**Roberts**  
22cm/8¾"



**Kelly**



19cm/7½"  
22cm/8¾"  
24cm/9½"

16-04495-19  
16-04495-22  
16-04495-24



16-04497-19  
16-04497-22  
16-04497-24



16-04499-19  
16-04499-22  
16-04499-24

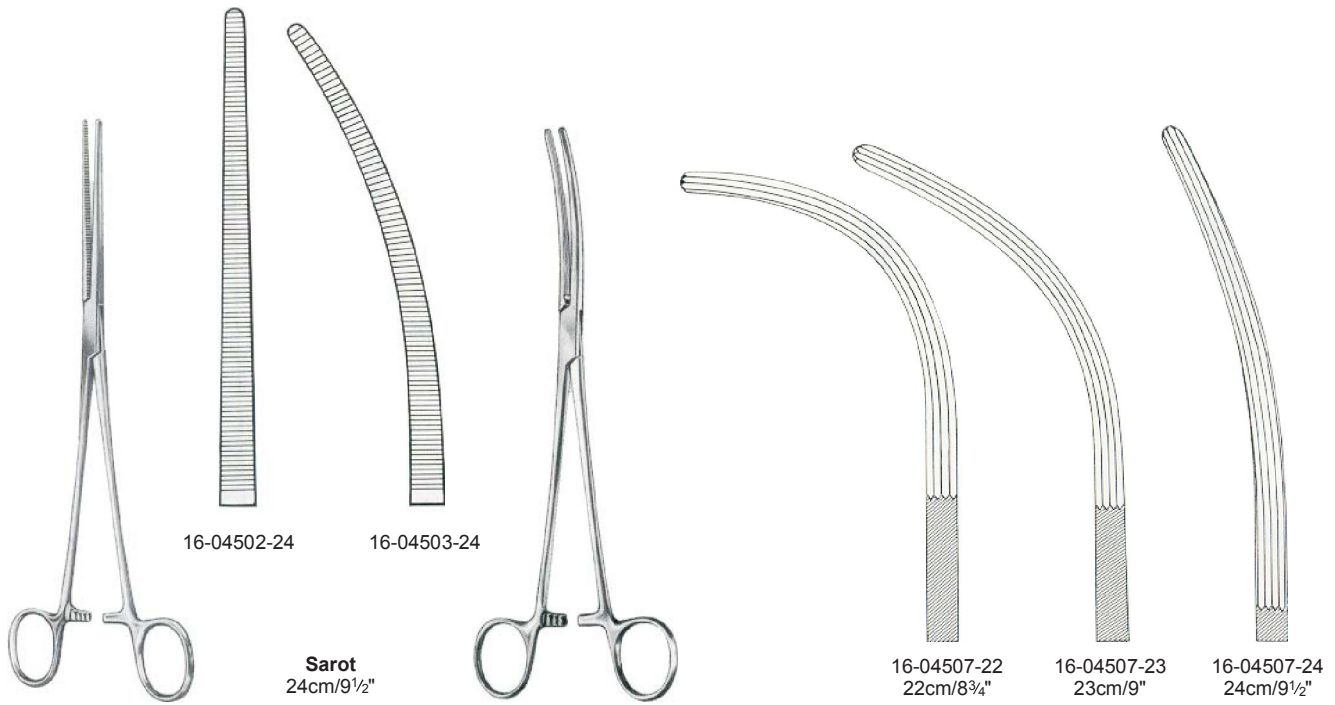

### Crafoord-Sellors

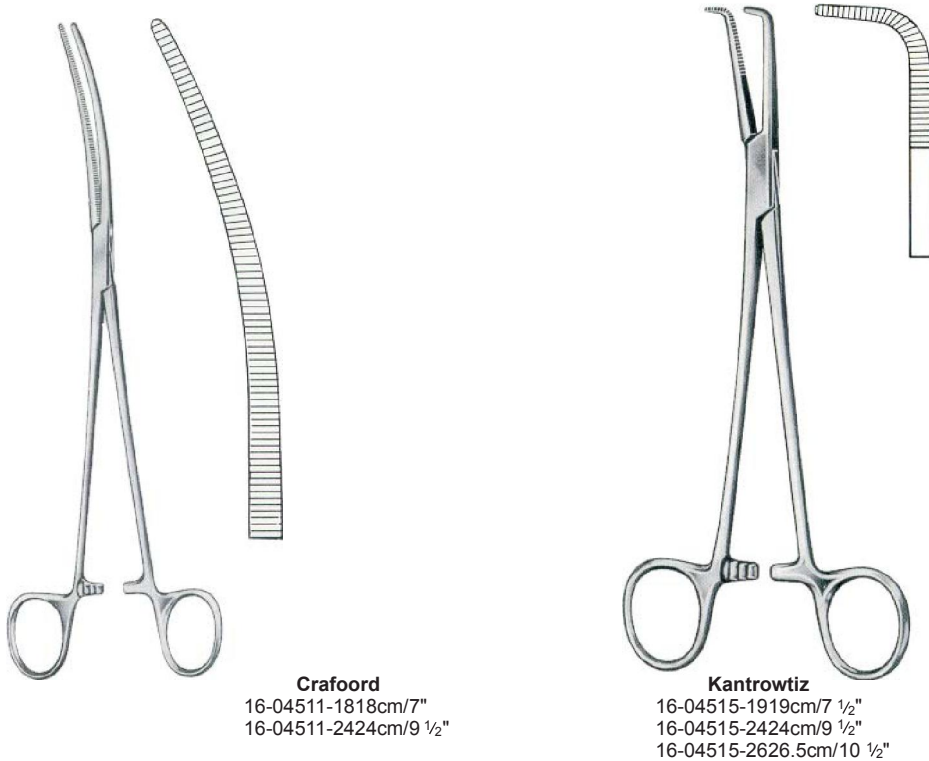



**Rumel**  
23cm/9"

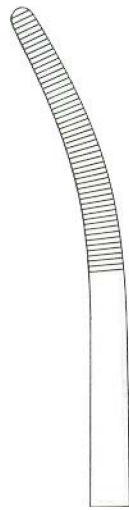

16-04519-23



16-04521-23



16-04523-23

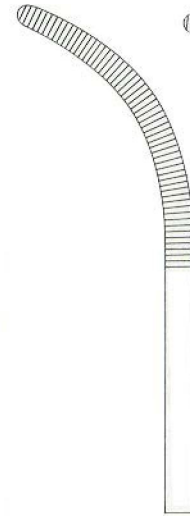

16-04525-23

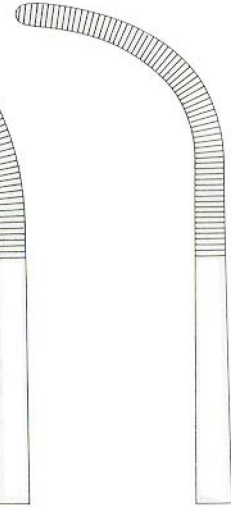

16-04527-23

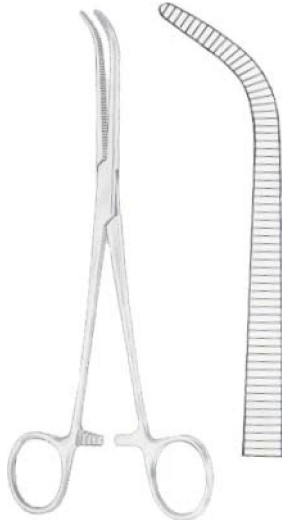

**Johns Hopkins**  
16-04531-20  
20cm/8"



**Zenker**  
29.5cm/11½"



16-04534-29



16-04535-29

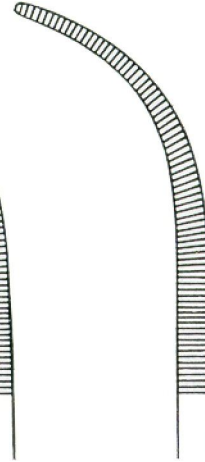

16-04537-29



**Baby-Overholt**  
16-04541-13  
13.5cm/5¼"



Overholt-Slim



16-04545-18  
18.5cm/7¼"

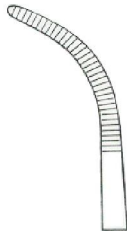

16-04547-20  
20.5cm/8"

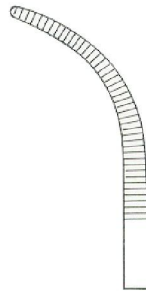

16-04549-21  
21cm/8¼"

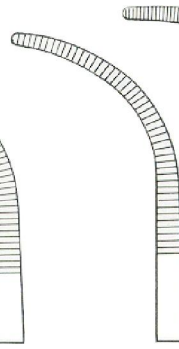

16-04551-21  
21.5cm/8½"

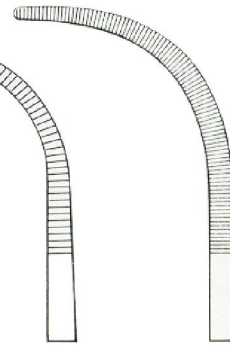

16-04553-24  
24cm/9½"



Overholt-Slim



16-04557-18  
18.5cm/7¼"



16-04559-20  
20.5cm/8"



16-04561-21  
21cm/8¼"

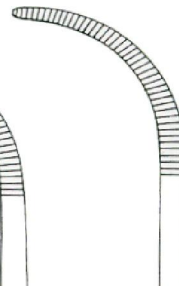

16-04563-21  
21.5cm/8¼"







**Overholt-Geissendorfer**  
21cm/8¼"  
27cm/10½"

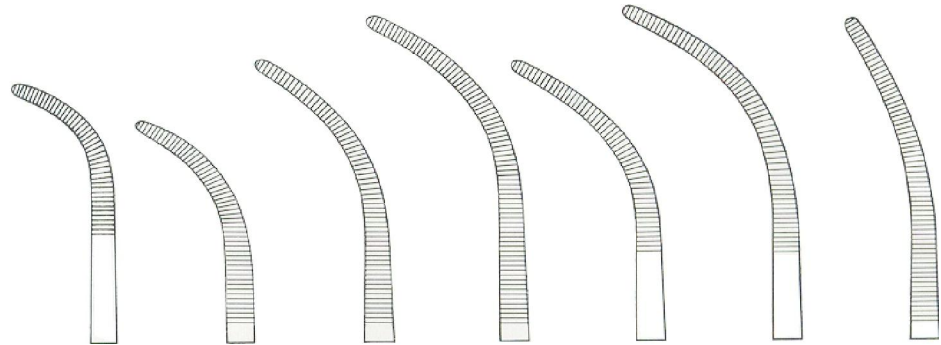

16-04567-21 16-04569-21 16-04571-21 16-04573-21 16-04575-21 16-04577-21 16-04579-21  
16-04567-27 16-04569-27 16-04571-27 16-04573-27 16-04575-27 16-04577-27 16-04579-27



**Overholt-Mixer**  
16-04581-21  
21cm/8¼"

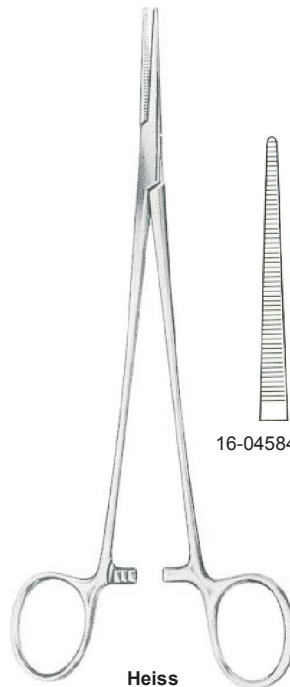

**Heiss**  
20cm/8"

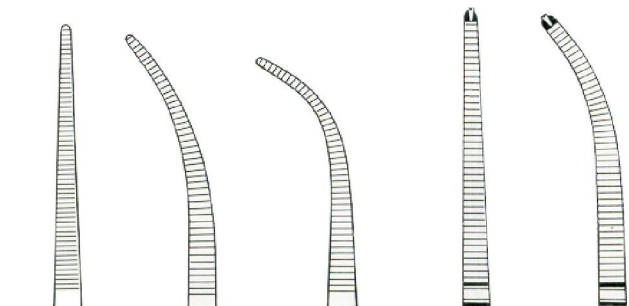

16-04584-20 16-04585-20 16-04587-20 16-04589-20 16-04591-20

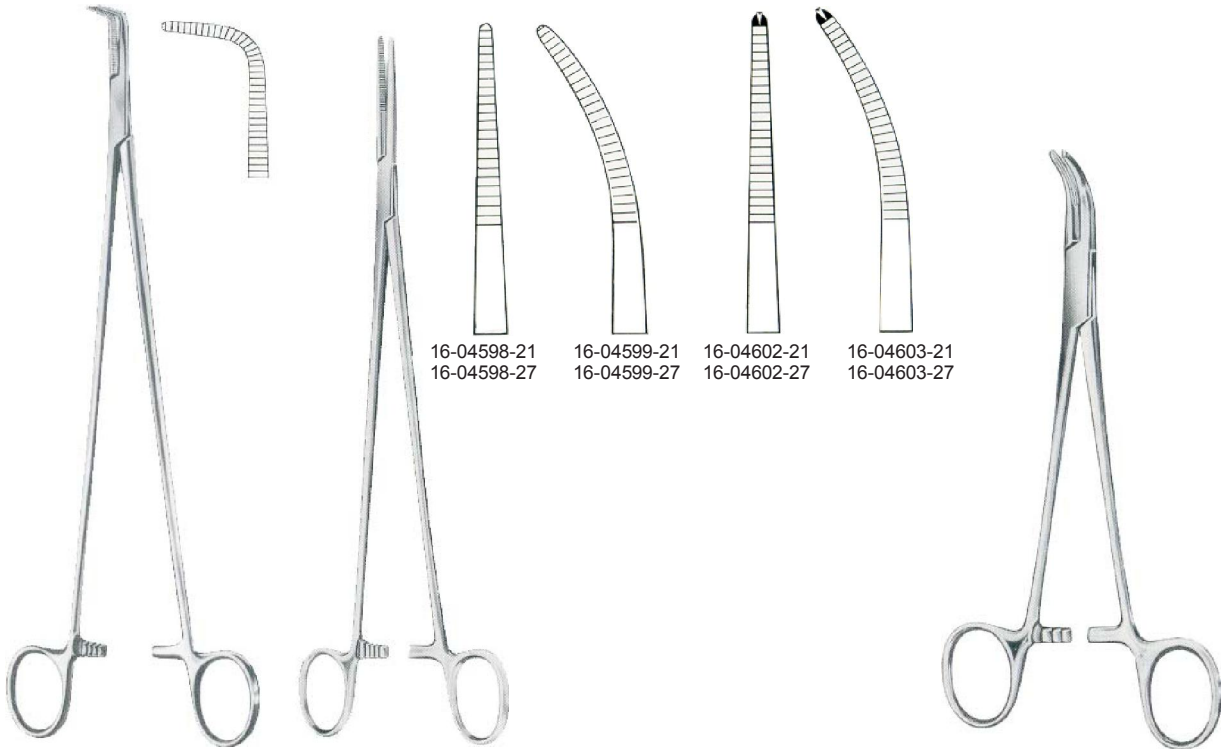

**Meeker**  
16-04595-27  
27cm/10 ½"

**Toennis**  
21cm/8 ¼"  
26cm/10 ¼"

**Lower**  
16-04607-18  
18cm/7"

16-04598-21  
16-04598-27

16-04599-21  
16-04599-27

16-04602-21  
16-04602-27

16-04603-21  
16-04603-27



**Gemini**

16-04611-13  
13cm/5"

16-04611-18  
18cm/7"

16-04611-20  
20cm/8"

16-04611-23  
23cm/9"

16-04611-25  
25cm/10"

16-04611-27  
27cm/10 ½"



**Mini-Gemini**

16-04615-18  
18cm/7"

16-04615-22  
22cm/8 3/4"

16-04615-25  
25cm/10"

16-04615-28  
28cm/11"

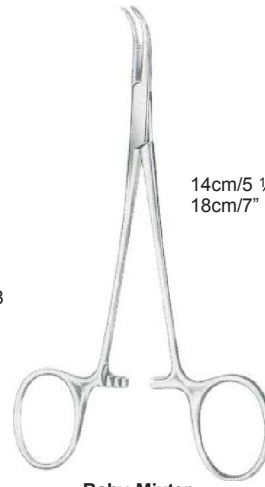

**Baby-Mixer**

14cm/5 1/2"  
18cm/7"

16-04619-14  
16-04619-18

16-04621-14  
16-04621-18



**Mixer**

16-04625-15 15cm/6"  
16-04625-19 19cm/7 1/2"



**Mixer-O'Shaugnessy**

16-04629-15 15.5cm/6"  
16-04629-19 19.0cm/7 1/2"

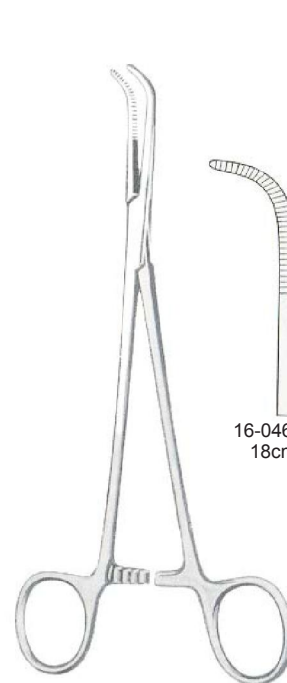

**Mixer-Slim**

16-04633-18  
18cm/7"

16-04633-23  
23cm/9"



16-04637-22  
22cm/8 3/4"

16-04637-25  
25cm/10"

16-04637-28  
28cm/11"

**Mixer**



**Mixer**  
16-04641-22  
22cm/8 3/4"



**Wickstroem**  
16-04645-20  
20cm/8"



**Finocchietto**  
16-04649-24  
24cm/9 1/2"



**McQuigg-Mixer**  
16-04653-22  
22cm/8 3/4"



**Lawrence**  
16-04657-27  
27.5cm/10 3/4"



**Lahey(Sweet)**

16-04661-19  
19cm/7 1/2"

16-04663-23  
23cm/9"



**Spencer-Wells**

16-04664-13	13cm/5"	16-04665-13
16-04664-15	15cm/6"	16-04665-15
16-04664-18	18cm/7"	16-04665-18
16-04664-20	20cm/8"	16-04665-20
16-04664-23	23cm/9"	16-04665-23



**Spencer-Wells**

16-04668-13	13cm/5"	16-04669-13
16-04668-14	14cm/5 1/2"	16-04669-14
16-04668-15	15cm/6"	16-04669-15
16-04668-18	18cm/7"	16-04669-18
16-04668-20	20cm/8"	16-04669-20
16-04668-23	23cm/9"	16-04669-23

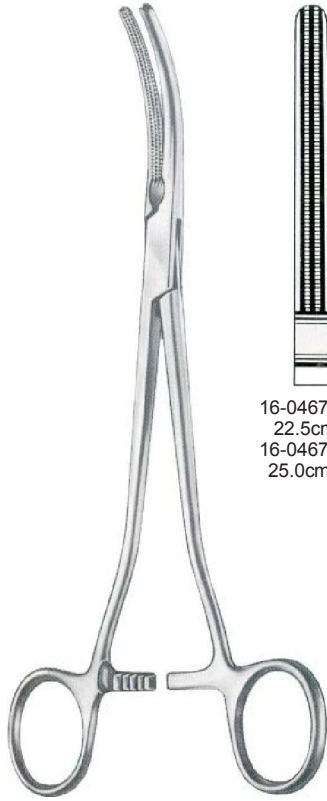

Rogers

16-04672-22  
22.5cm/9"  
16-04672-25  
25.0cm/10"

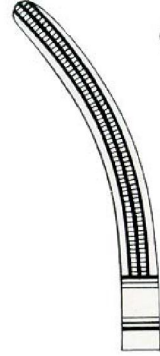

16-04673-22  
22.0cm/8 3/4"  
16-04673-24  
24.5cm/9 3/4"

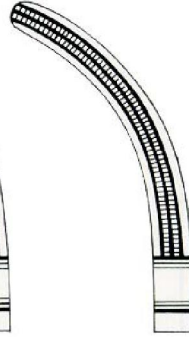

16-04675-21  
21.5cm/8 1/2"  
16-04675-24  
24.0cm/9 1/2"

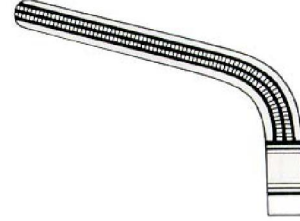

16-04679-20  
20.5cm/8"  
16-04679-23  
23.5cm/9"



Heaney

19.5cm/7 1/2"  
21.5cm/8 1/4"  
23.5cm/9"



16-04683-19  
16-04683-21  
16-04683-23



16-04685-19  
16-04685-21  
16-04685-23



Heaney-Slim  
16-04687-21  
21cm/8 1/4"





**Ballentine**  
16-04690-21  
21cm/8¼"



**Heaney-Ballentine**  
16-04691-21  
21cm/8¼"



Tonsil Forceps

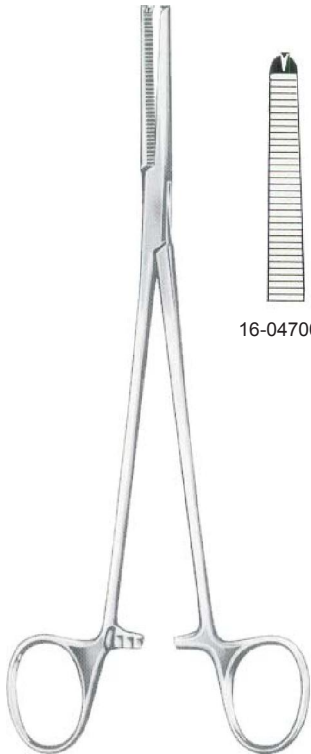

Fig. 1



Fig. 2

**Negus**  
16-04695-19 19cm/7½" 16-04697-19



**Phaneuf**  
21.5cm/8½"



16-04700-21



16-04701-21

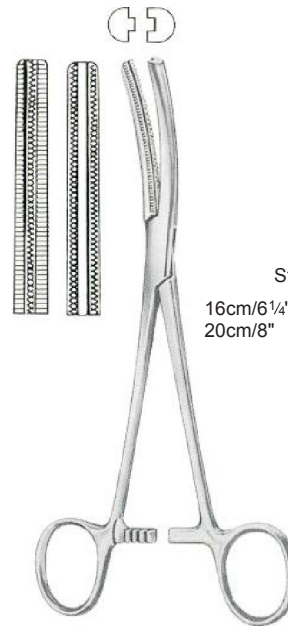

**Fergusson**

Haemorrhoidal Clamps



	<b>Straight</b>		<b>Curved</b>
16cm/6¼"	16-04704-16	16-04705-16	
20cm/8"	16-04704-20	16-04705-20	

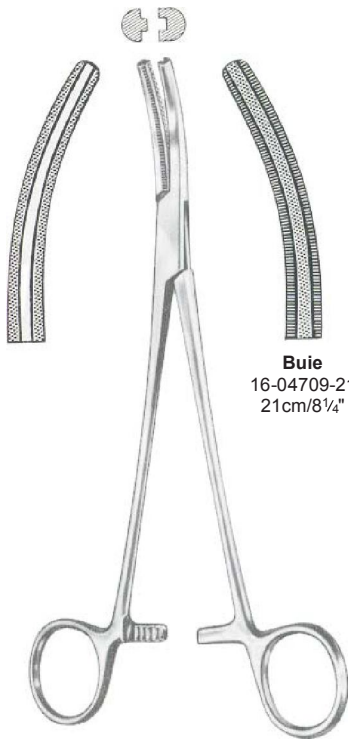

**Buie**  
16-04709-21  
21cm/8¼"

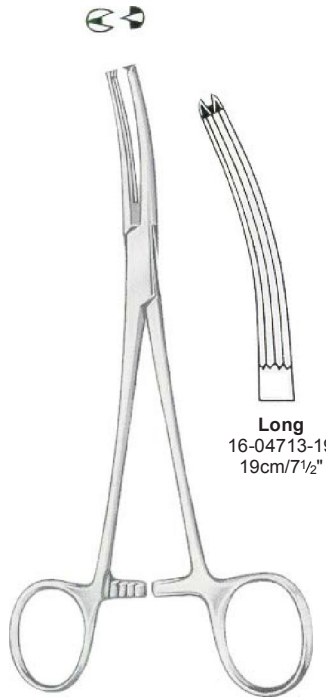

**Long**  
16-04713-19  
19cm/7½"



**Garland**  
16-04717-21  
21cm/8¼"

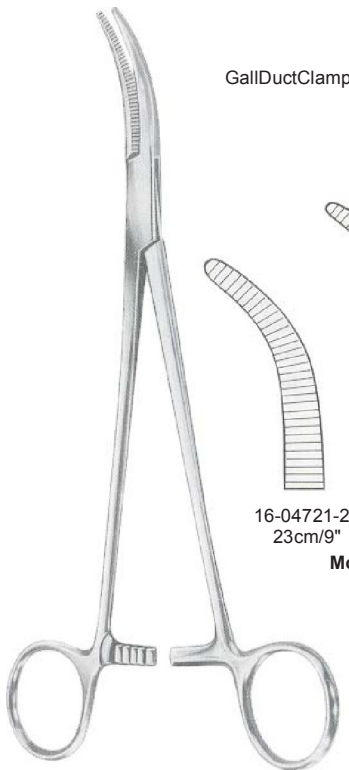

GallDuctClamps

16-04721-23 23cm/9"  
16-04723-24 24cm/9½"  
**Moynihan**



HysterectomyForceps

16-04726-23 16-04727-23  
**Hozlback**  
23.5cm/9¼"



PressureClamps

**Zweifel**  
16-04730-17  
17.5cm/7"

ScalpFlapForceps



**Martel**  
16-04733-14  
14cm/5½"

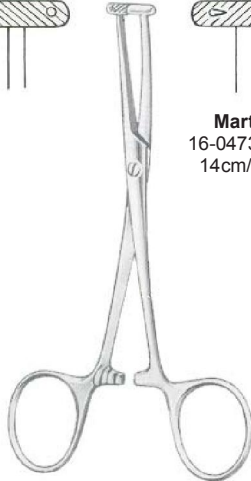

**Wertheim**  
16-04736-25  
25cm/10"



ExtraStrong



**Wertheim-Cullen**  
16-04739-21  
21.5cm/8½"



**Wertheim**  
16-04743-24  
24cm/9½"

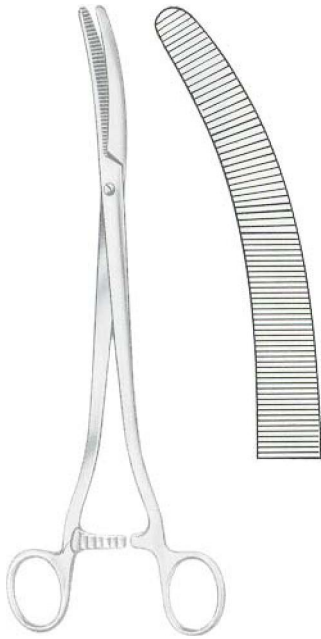

**Faure**  
16-04747-25  
25cm/10"



23cm/9"

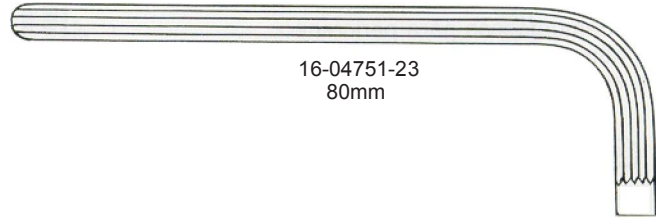

16-04751-23  
80mm

60mm

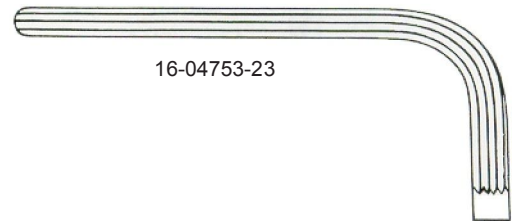

16-04753-23



**Wertheim**  
22cm/8¾"



SlightlyCurved  
16-04755-22



MoreCurved  
16-04757-22

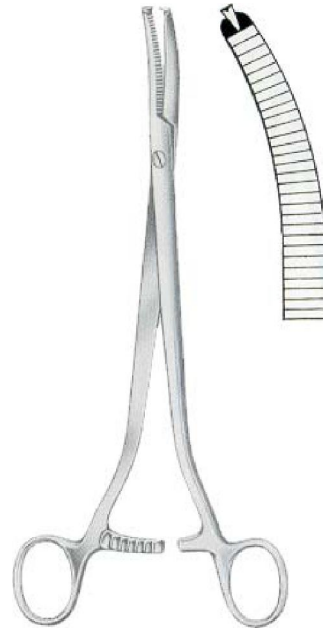

**Wertheim**  
16-04761-22  
22cm/8¾"

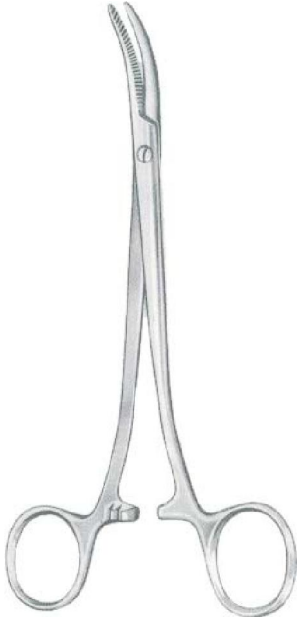

**Wertheim**  
16-04765-18  
18cm/7"

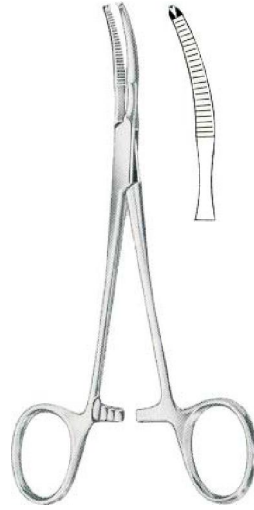

**Baby-Mikulicz**  
16-04769-14  
14cm/5 1/2"

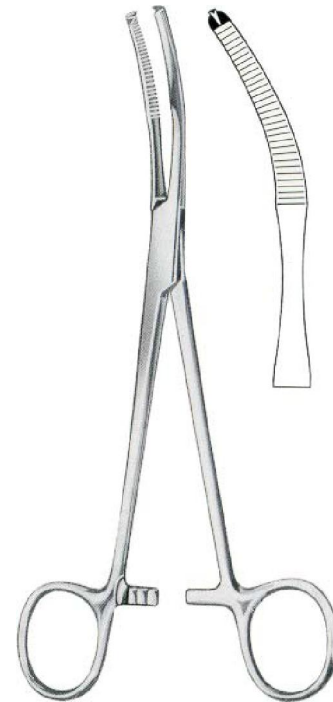

**Mikulicz**  
16-04773-18 18cm/7"  
16-04773-20 20cm/8"



**Mikulicz**  
16-04777-20  
20cm/8"

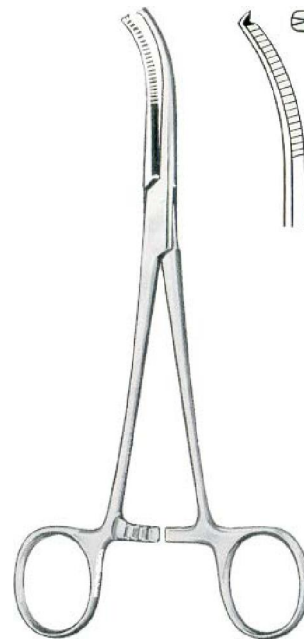

**Mikulicz**  
16-04781-18  
18.5cm/7 1/4"

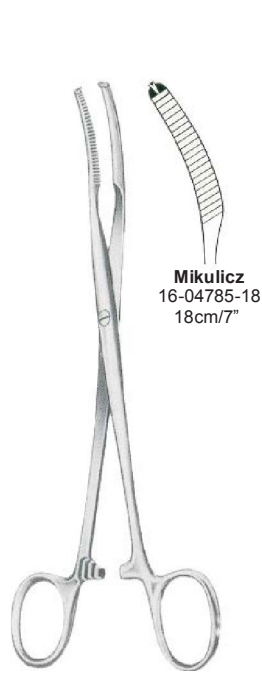

**Mikulicz**  
16-04785-18  
18cm/7"

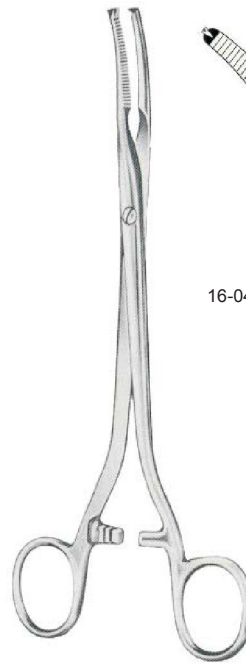

**Mikulicz**  
16-04789-20 20cm/8" 16-04791-20



**Segond-Landau**  
16-04794-24  
24cm/9 1/2"



**Segond**  
16-04795-24  
24cm/9 1/2"



**Faure**  
16-04799-20 20cm/8" 16-04801-20

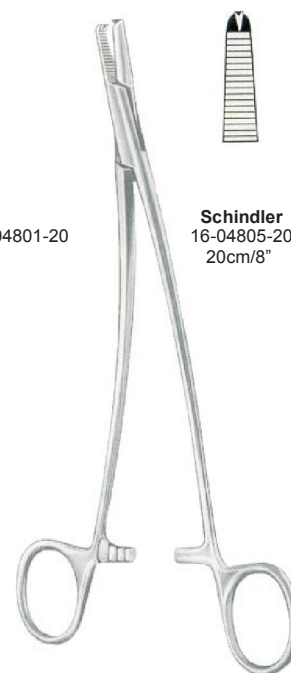

**Schindler**  
16-04805-20  
20cm/8"





**Schadel**  
16-04808-09 9cm/3 1/2"



**Jones**  
16-04812-055cm/2"  
16-04812-099cm/3 1/2"



**Engl-Modell**  
16-04816-09 9cm/3 1/2"



**Backhaus**  
16-04820-09 9cm/3 1/2"  
16-04820-1111cm/4 1/2"  
16-04820-1313cm/5"  
16-04820-1515cm/6"

WithclipforTubingorCable



16-04824-1111cm/4 1/2"  
16-04824-1313cm/5"



**Peers-Bertram**  
16-04828-14 14.5cm/5 3/4"



**Tohoku**  
16-04832-1010cm/4"  
16-04832-1313cm/5"



**Roder**  
16-04836-13 13cm/5"  
16-04836-15 15cm/6"



**Lorna**  
16-04840-10 10cm/4"  
16-04840-13 13cm/5"



**Bernhard**  
16-04844-16 16.5cm/6 1/2"



**Lane**  
16-04848-20  
20cm/8"



**Doyen**  
16-04852-18  
18cm/7"



16-04856-14 14cm/5 1/2"  
 16-04856-15 15cm/6"  
 16-04856-18 18cm/7"  
 16-04856-20 20cm/8"



16-04860-14  
 14.5cm/5 3/4"



16-04864-16 16.5cm/6 1/2"  
 16-04864-18 18.0cm/7"



16-04868-15 15cm/6"  
 16-04868-18 18cm/7"  
 16-04868-20 20cm/8"



**Mohr**  
 16-04872-50 50mm  
 16-04872-60 60mm  
 16-04872-70 70mm  
 16-04872-80 80mm

Sizes  
 mm  
 13  
 17  
 20  
 25  
 30

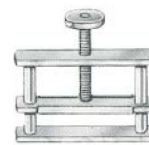

**Hoffmann**  
 16-04876-13  
 16-04876-17  
 16-04876-20  
 16-04876-25  
 16-04876-30



**Hoffmann**  
 16-04880-13  
 16-04880-17  
 16-04880-20  
 16-04880-25  
 16-04880-30



**Ulrich**

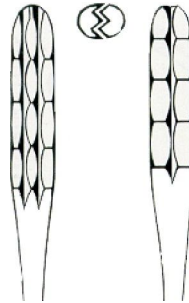

Straight

16-04884-22  
16-04884-25  
16-04884-27

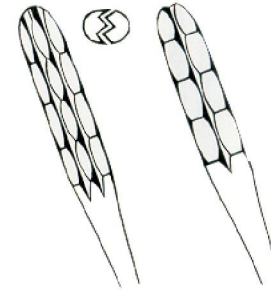

Curved

22cm/8 3/4"  
25cm/10"  
27cm/10 1/2"

16-04885-22  
16-04885-25  
16-04885-27



**Lister**

16-04888-13	13cm/5"	16-04890-13
16-04888-15	15cm/6"	16-04890-15
16-04888-18	18cm/7"	16-04890-18



**Bryant**

16-04894-13  
13cm/5"

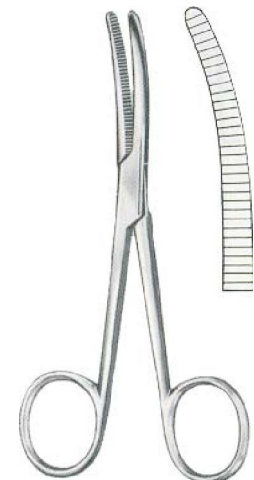

**Bryant**

16-04896-13  
13cm/5"



**Gross-Maier**



Straight

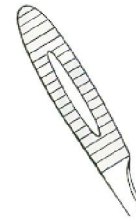

Curved

With Ratchet

16-04900-20  
16-04900-25

20cm/8"  
25cm/10"

16-04901-20  
16-04901-25

Without Ratchet

16-04904-20  
16-04904-25

20cm/8"  
25cm/10"

16-04905-20  
16-04905-25



**Pelkman**  
25cm/10"



16-04908-25



16-04909-25

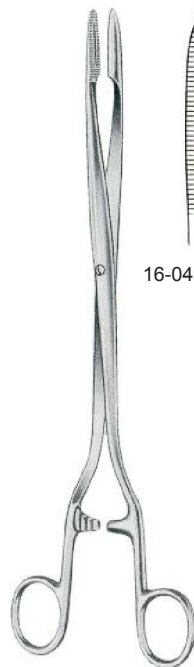

**Sims-Maier**  
28cm/11"



16-04912-28



16-04913-28



**Duplay**  
20cm/8"



16-04916-20



16-04917-20

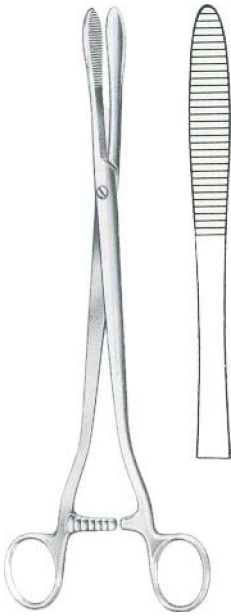

**Collin**  
16-04920-25  
25cm/10"

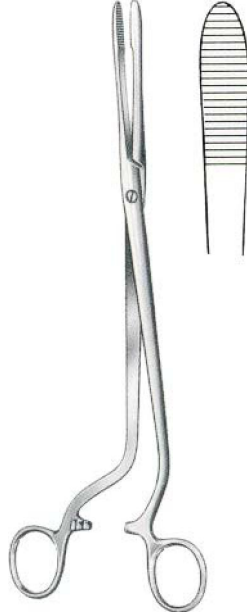

**Cheron**  
16-04924-25  
25cm/10"



**Emmet**  
16-04928-21  
21cm/8¼"



**Bozemann**  
16-04932-26  
26cm/10¼"



**Bozemann**  
26cm/10¼"



16-04935-26



16-04937-26

Smooth





**Bozemann-Douglas**  
16-04941-26  
26cm/10 1/4"

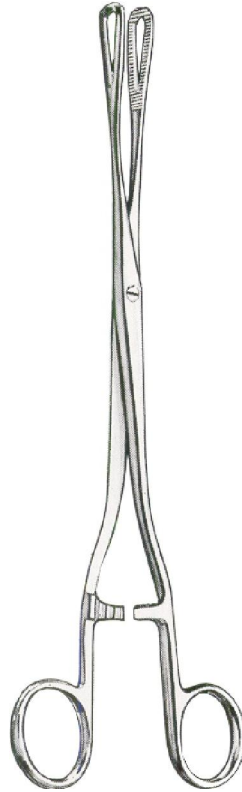

**Rampley**  
16-04944-1818cm/7"  
16-04944-2424cm/9 1/2"



**Rampley**  
16-04946-1818cm/7"  
16-04946-2424cm/9 1/2"



**Foerster**

18cm/7"  
20cm/8"  
24cm/9 1/2"  
25cm/10"



16-04950-18  
16-04950-20  
16-04950-24  
16-04950-25

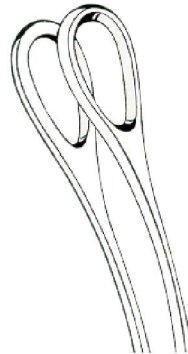

16-04951-18  
16-04951-20  
16-04951-24  
16-04951-25



16-04954-18  
16-04954-20  
16-04954-24  
16-04954-25

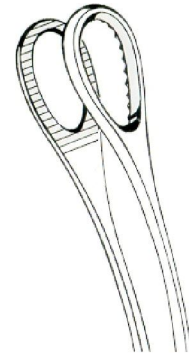

16-04955-18  
16-04955-20  
16-04955-24  
16-04955-25



**Schwartz**  
16-04959-19  
19cm/7½"



16-04962-01



16-04962-02



16-04962-03

Applying Forceps



16-04966-23  
23cm/9"



**Diethrich**

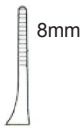

16-04970-08



16-04970-12



16-04970-20



16-04971-08

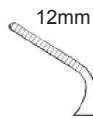

16-04971-12



16-04971-20

**Atrauma**



16-04974-10



16-04974-14



16-04974-20



16-04975-10



16-04975-14



16-04975-20

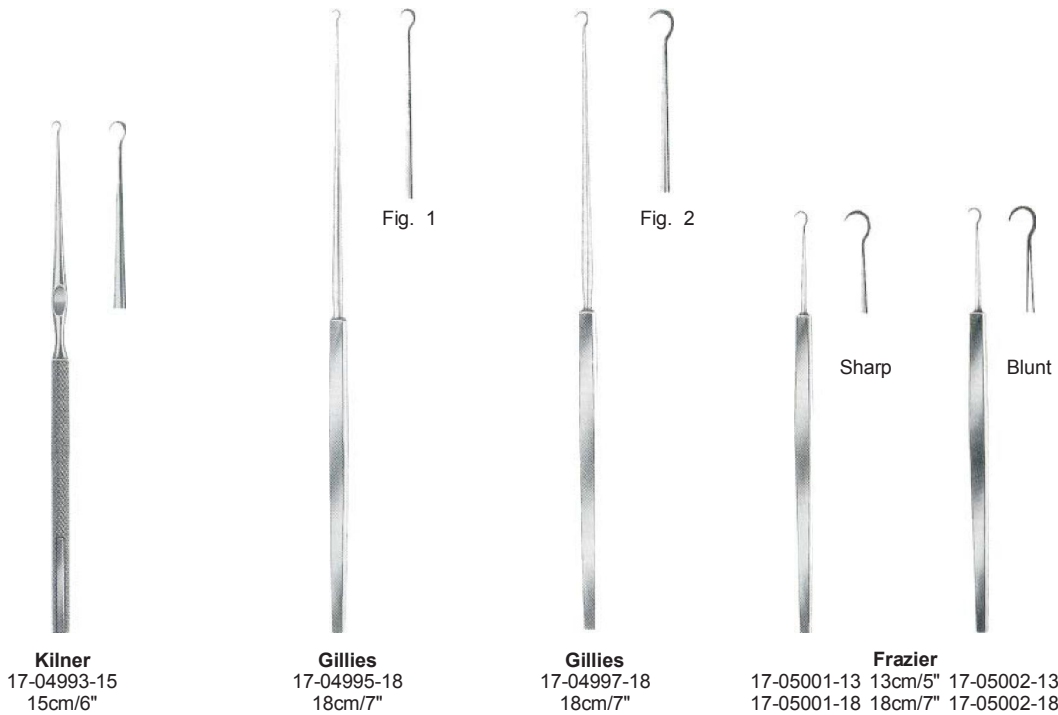
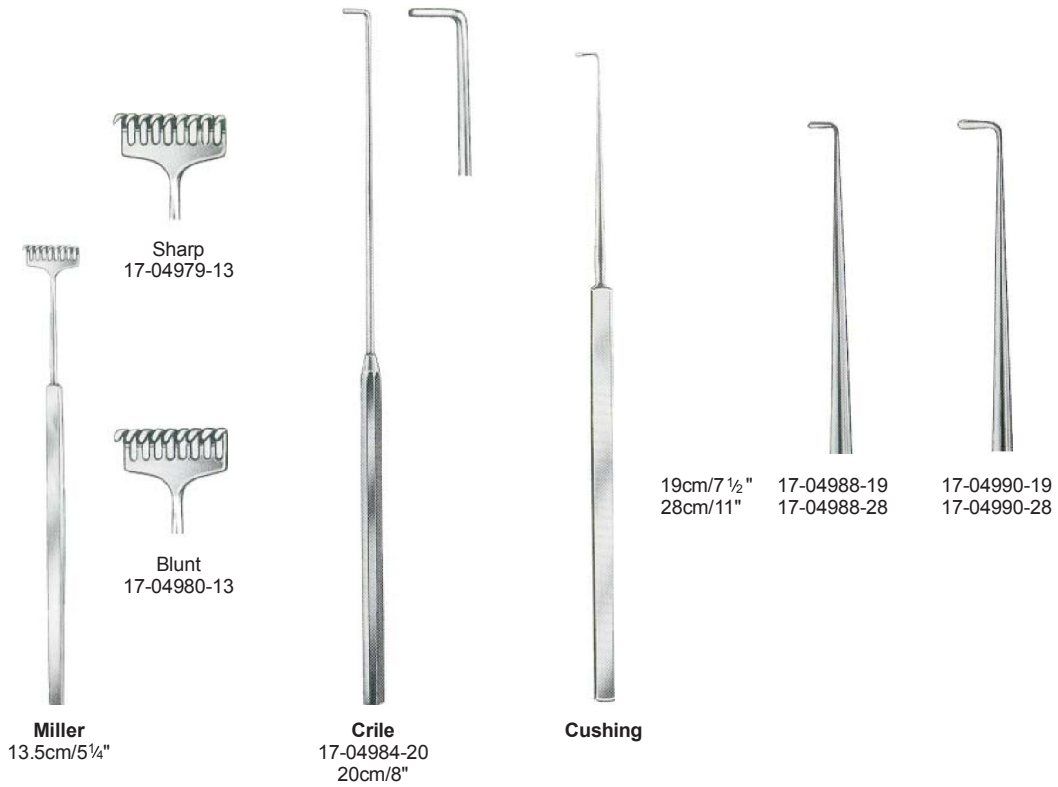

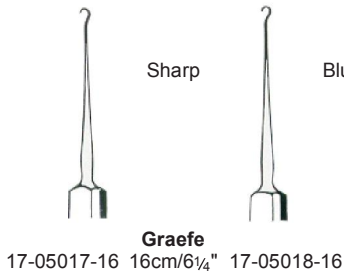
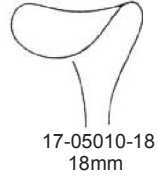
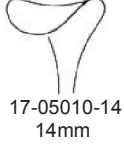
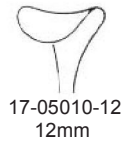
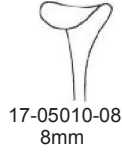

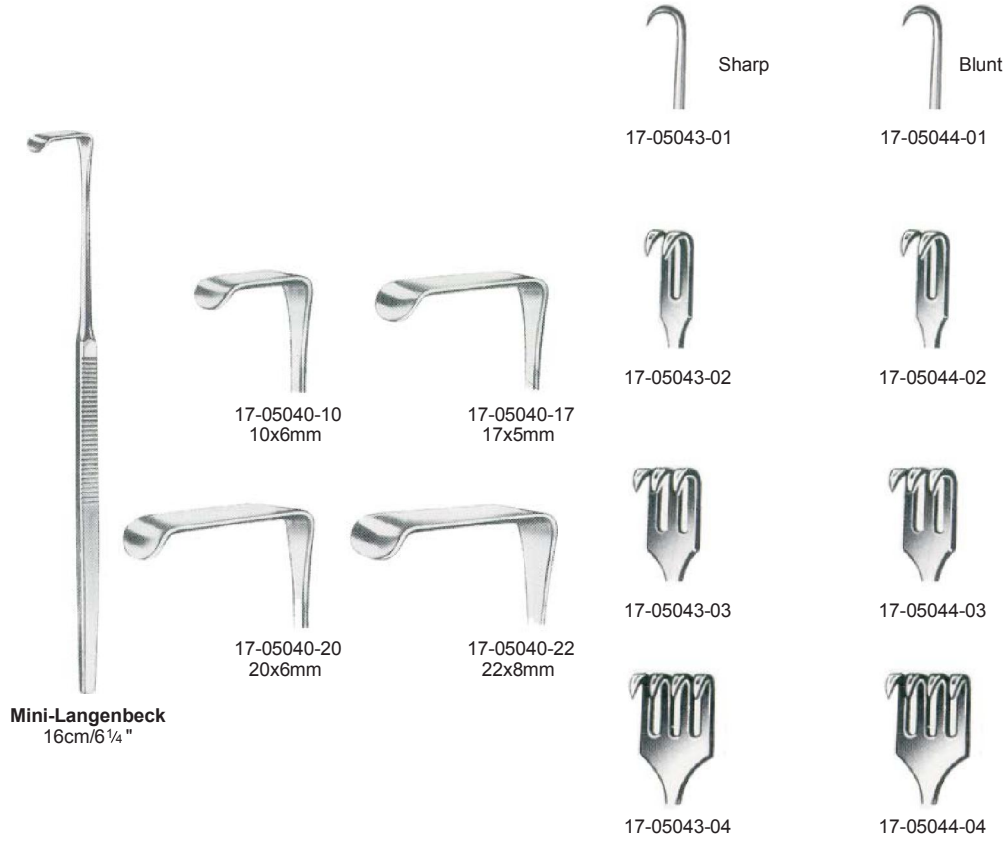

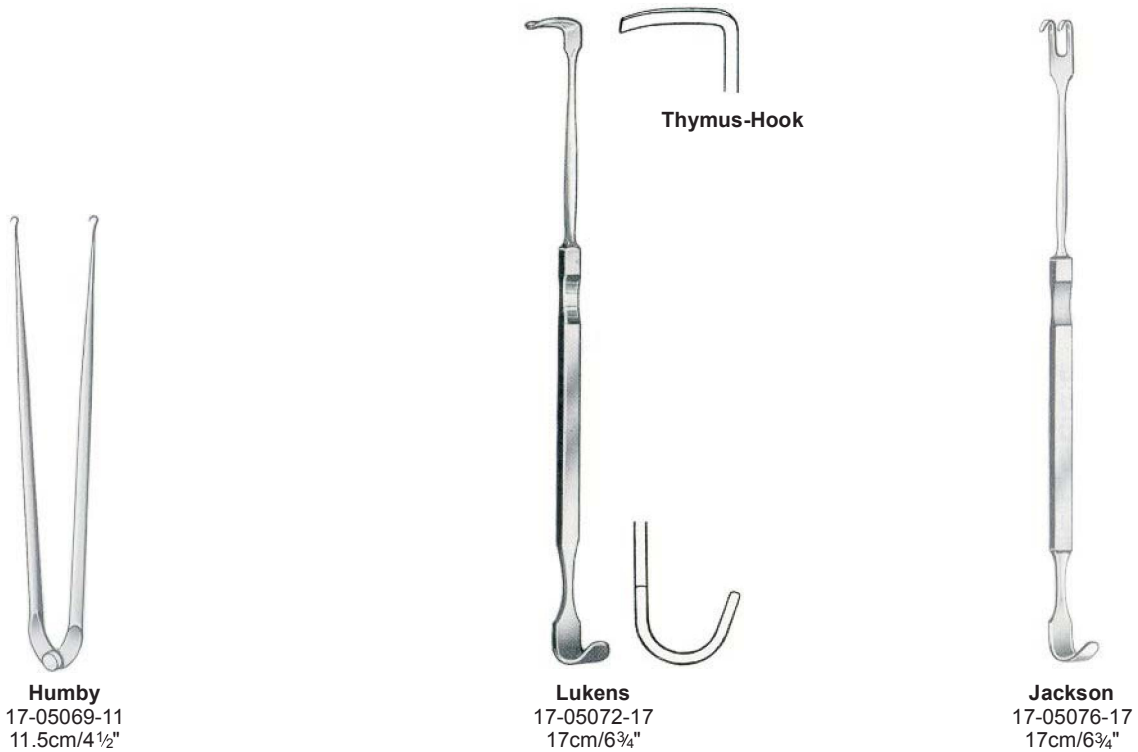
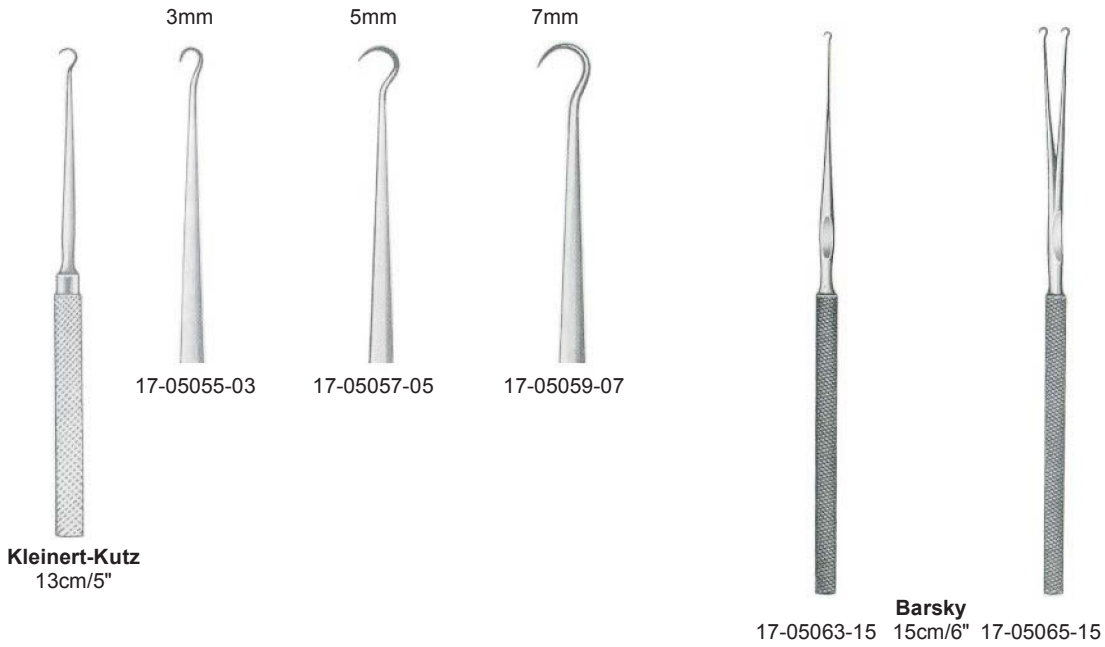



Malleable



**Gil-Vernet**  
24cm/9½"

08mm17-05080-08	17-05082-08
11mm17-05080-11	17-05082-11
15mm17-05080-15	17-05082-15
17mm17-05080-17	17-05082-17
20mm17-05080-20	17-05082-20
23mm17-05080-23	17-05082-23

Malleable



24cm/9½"

12x14mm



**Little**  
17-05085-20  
20cm/8"



**Love-(Morse)**  
25cm/10"

10mm17-05086-10  
15mm17-05086-15  
20mm17-05086-20  
30mm17-05086-30  
40mm17-05086-40  
50mm17-05086-50

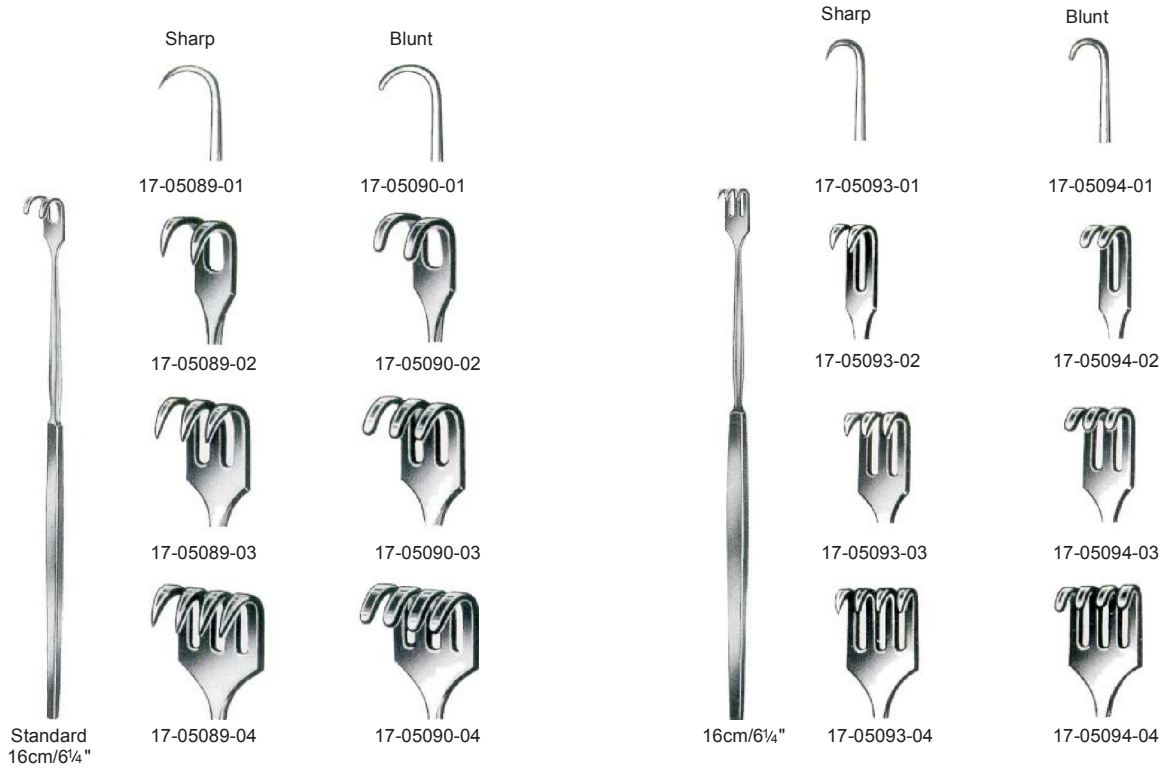



17-05106-02  
13.5cm/5¼"



**Jackson**  
17-05109-13  
13cm/5"



**Bergmann**  
17-05113-14  
14cm/5½"



**Iterson**  
16cm/6¼"



17-05117-16



17-05119-16



**Meyerding**  
18cm/7"



17-05122-18  
18x7mm



17-05128-18  
16x5mm



17-05124-18  
7x4mm



17-05130-18  
10x3mm



17-05126-18  
7x4mm



17-05132-18



**Volkmann**  
11.5cm/4½"



Sharp  
17-05135-02



Blunt  
17-05136-02



17-05135-03



17-05136-03



17-05135-04



17-05136-04



17-05135-06



17-05136-06

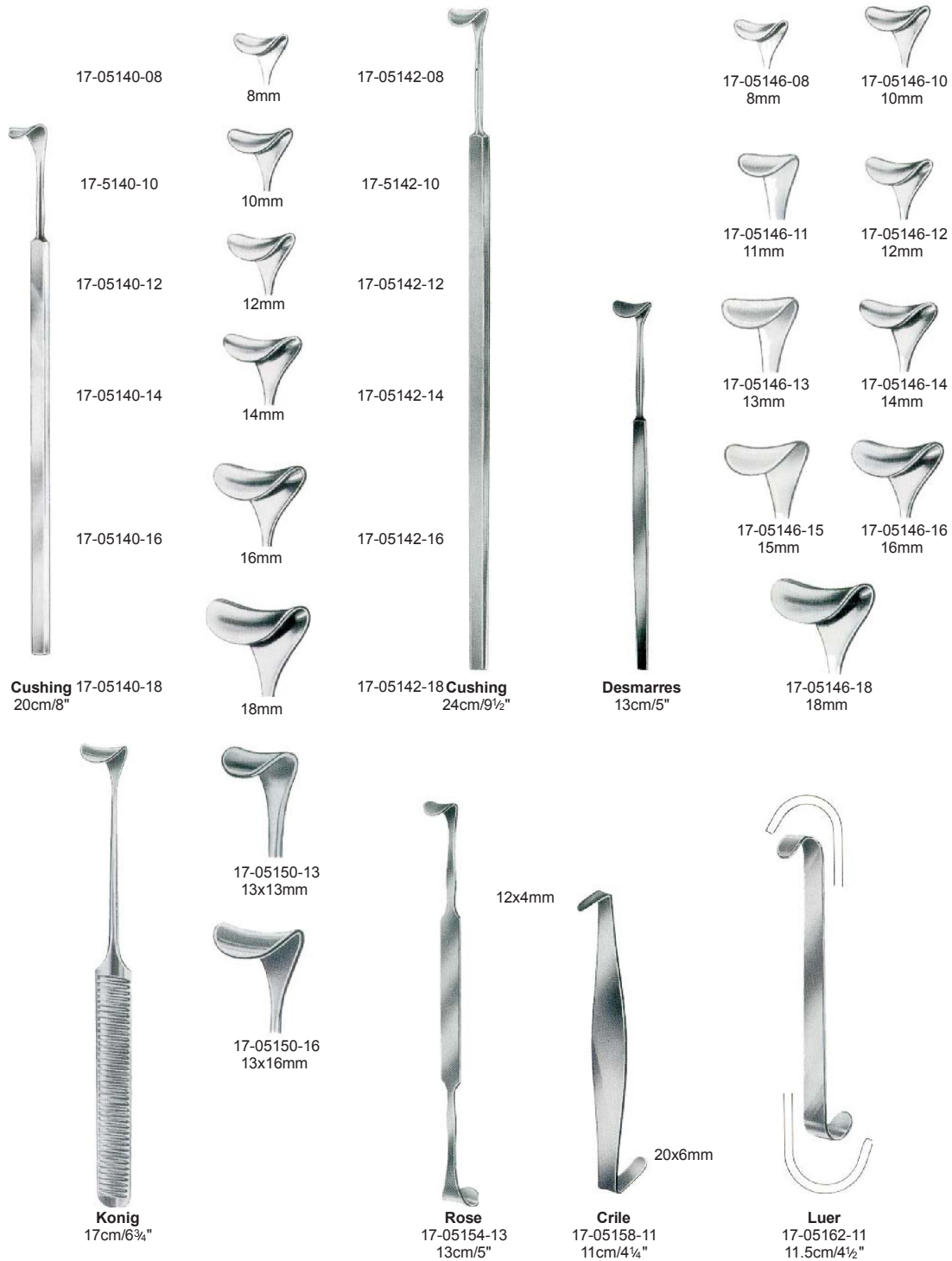



**Cushing-Kocher**  
17-05166-18  
18cm/7"

10x10mm



**Langenbeck-Green**  
17cm/6¾"

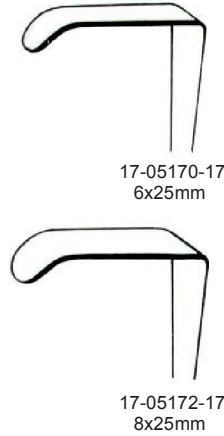

17-05170-17  
6x25mm

17-05172-17  
8x25mm



**Strandell-Stillé**  
19cm/7½"

TendonSheathHook



17-05176-19



toothed

17-05178-19

TendonSheathHook



**Klapp**  
17.5cm/7"



17-05182-02



17-05182-03



17-05182-04

DecompressionHook



**Cushing**  
17-05186-20  
20cm/8"

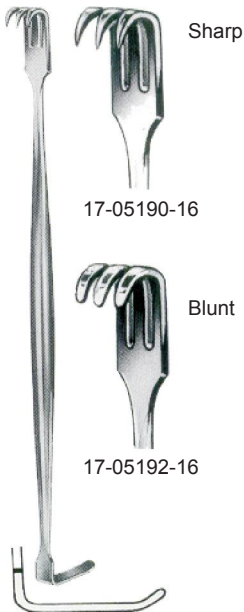

**Senn-Miller**  
16cm/6¼"

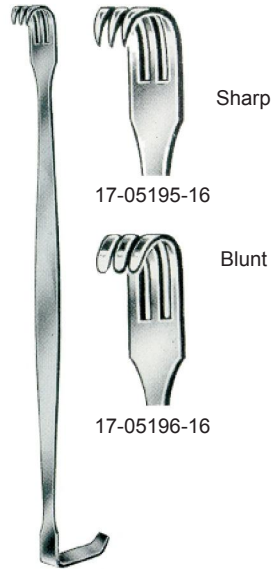

**Baby-Senn-Miller**  
16cm/6¼"



**Rangell-Davis**  
17-05200-14  
14cm/5½"



**Senn-Green**  
15cm/6"



**Langenbeck-Green**  
16cm/6¼"



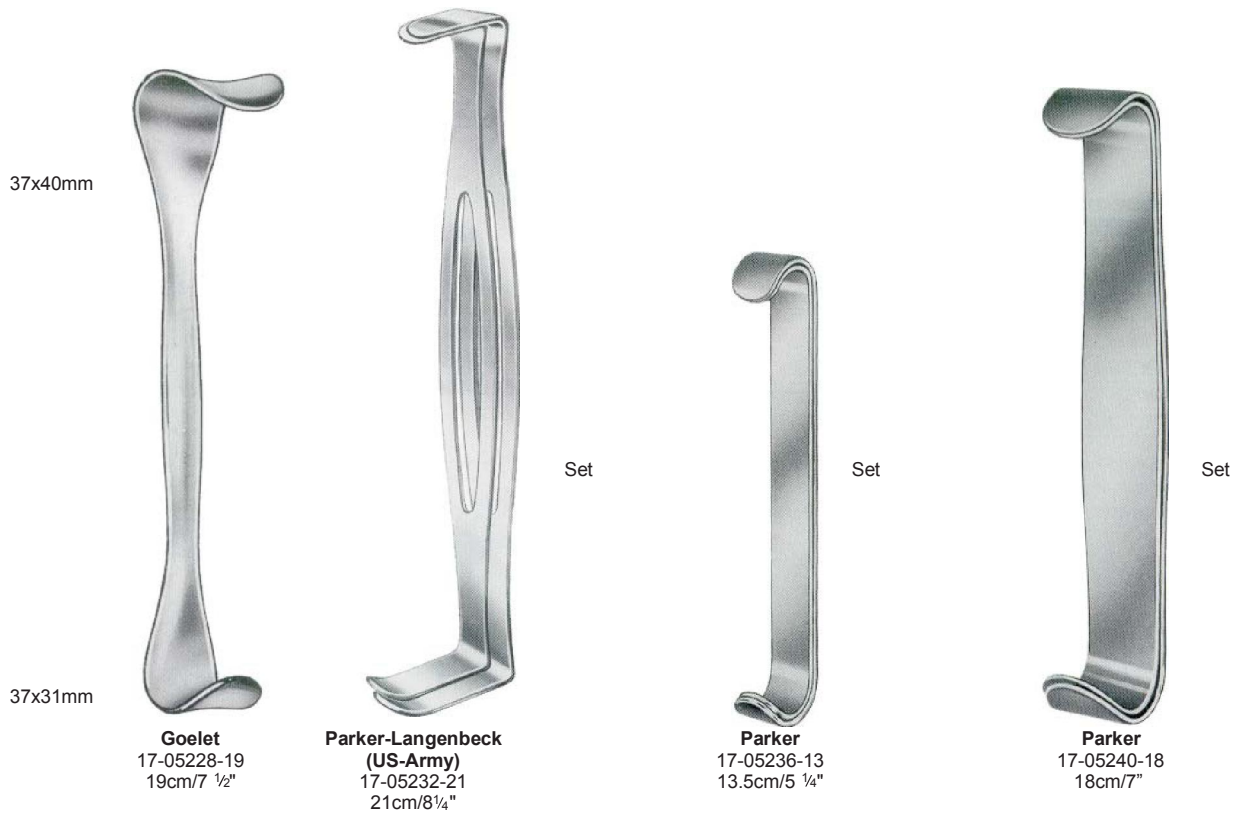
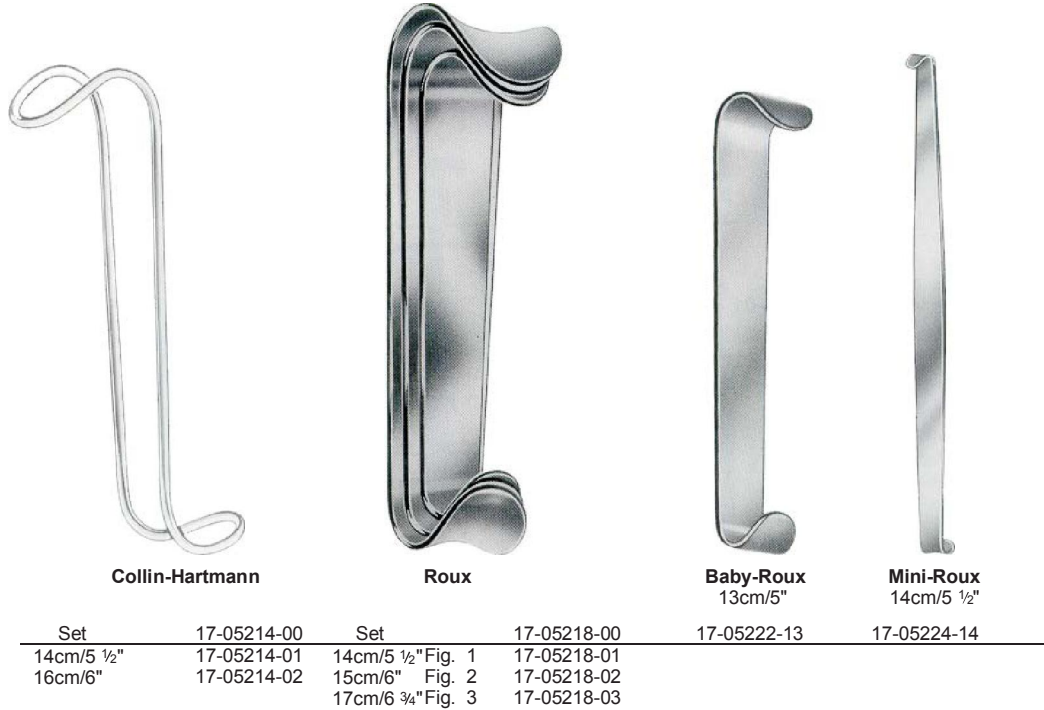



Set

**Parker-Mott**  
17-05244-16  
16cm/6 ¼"



Set

**Farabeuf**  
17-05248-12  
12cm/4 ¾"



Set

**Farabeuf**  
17-05250-15  
15cm/6"

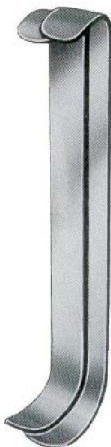

Set

**Collin**  
17-05254-16  
16.5cm/6 ½"



Set

**Mayo-Collin**  
17-05256-15  
15cm/6"



Set

**Mathieu**  
17-05260-19  
19cm/7 ½"

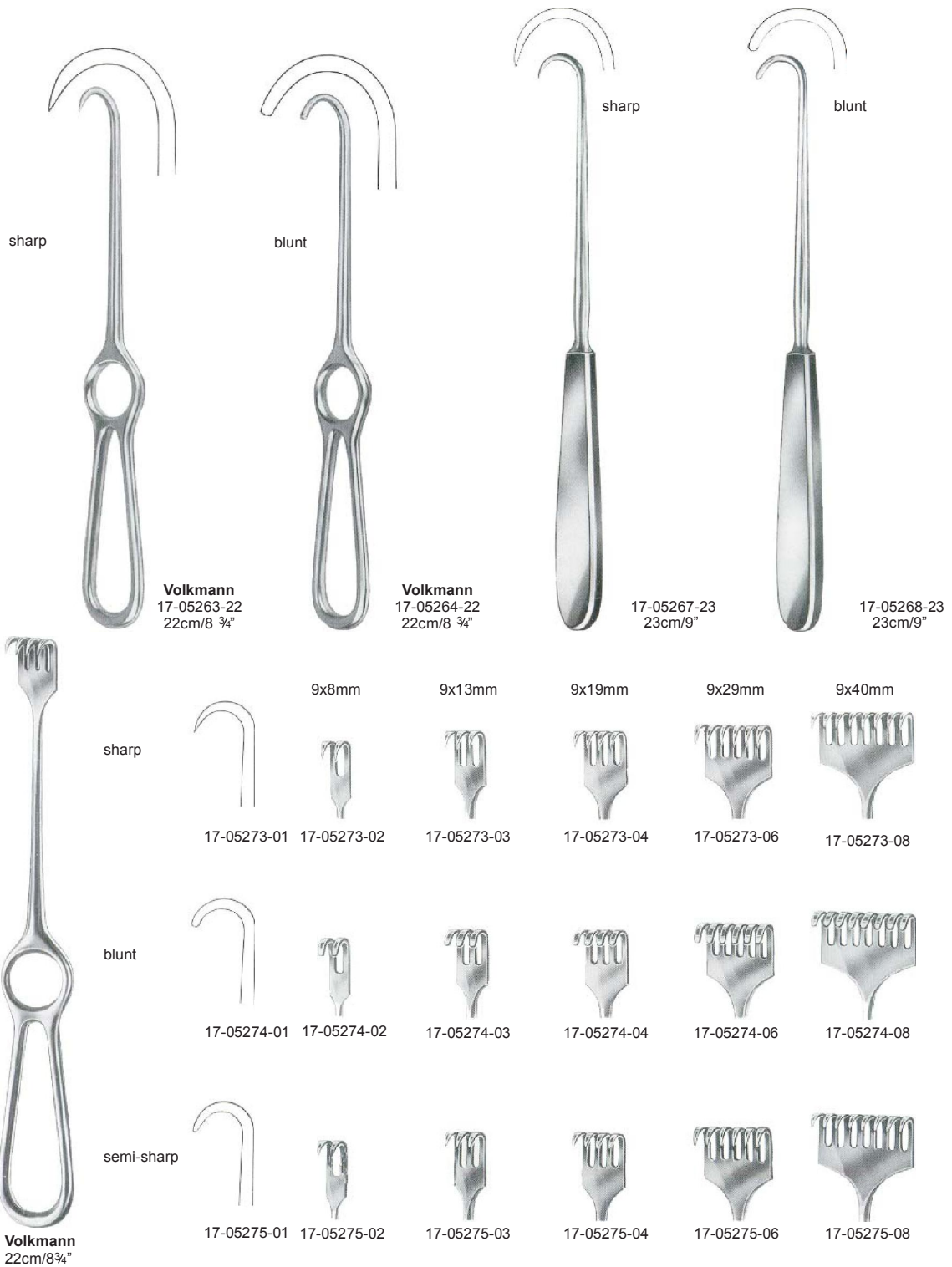



**Volkmann**  
23cm/9"



9x8mm



9x13mm



9x19mm



9x29mm

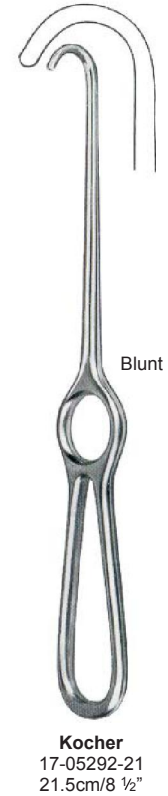
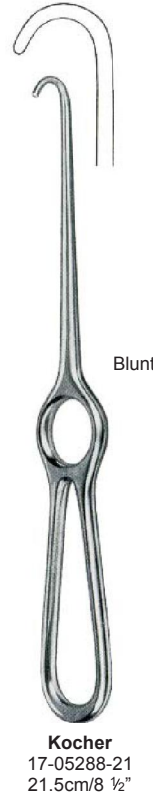
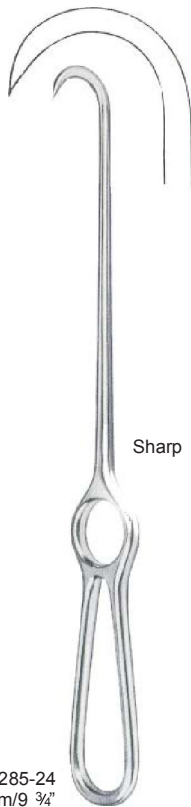
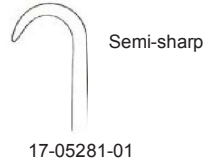

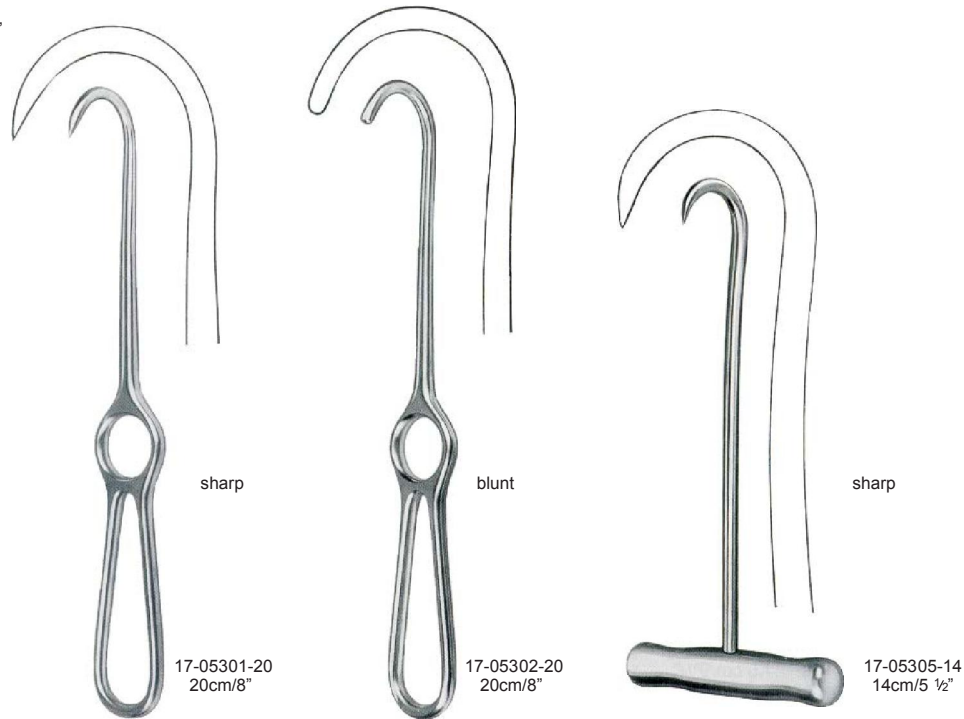



17-05308-03  
36x30mm



17-05308-04  
36x60mm

**Ollier**  
22.5cm/9"



**Murphy**  
19.5cm/7 3/4"

Sharp



17-05311-02



17-05311-03



17-05311-04



17-05311-06

blunt

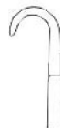

17-05312-02



17-05312-03



17-05312-04



17-05312-06



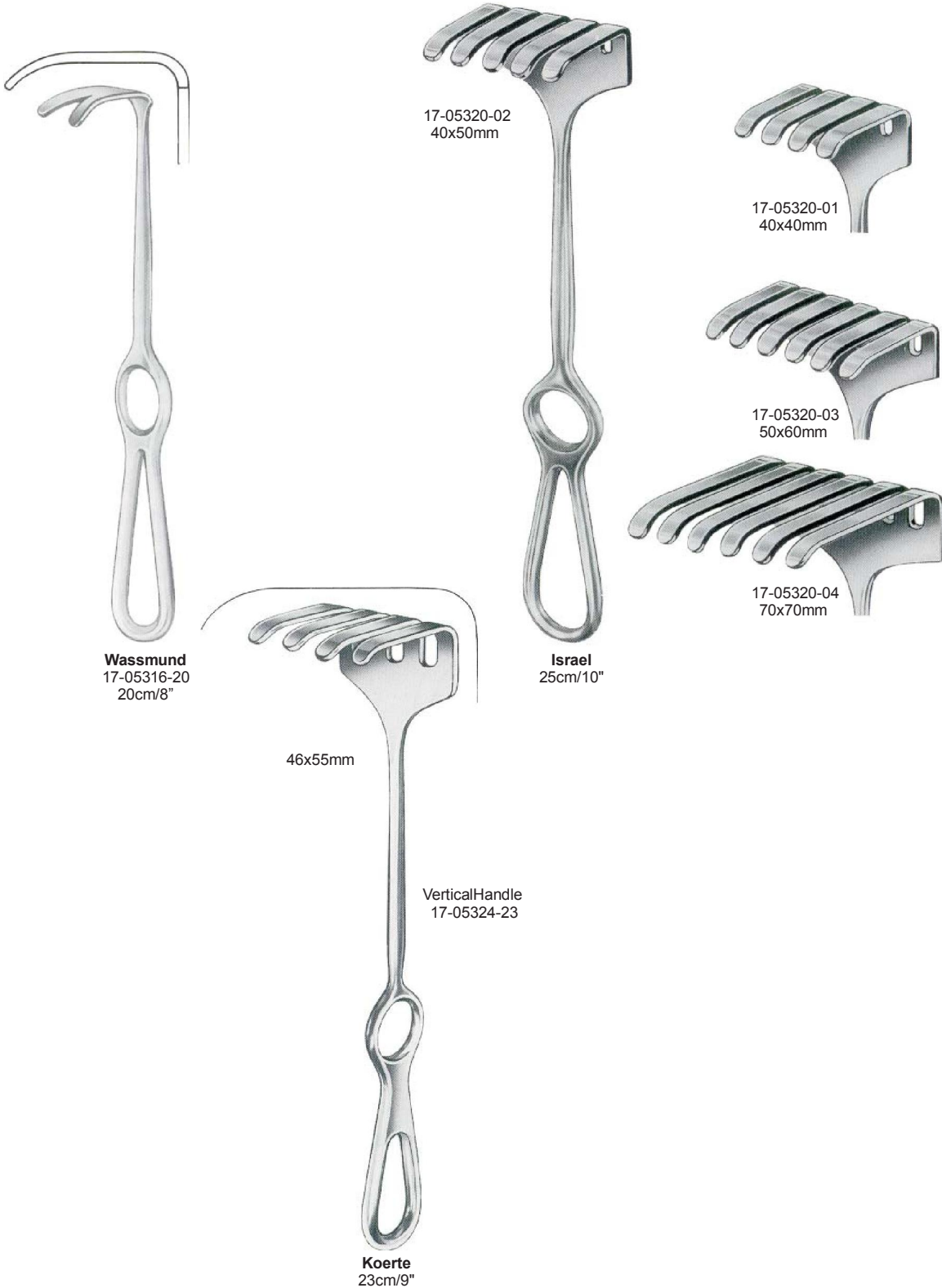



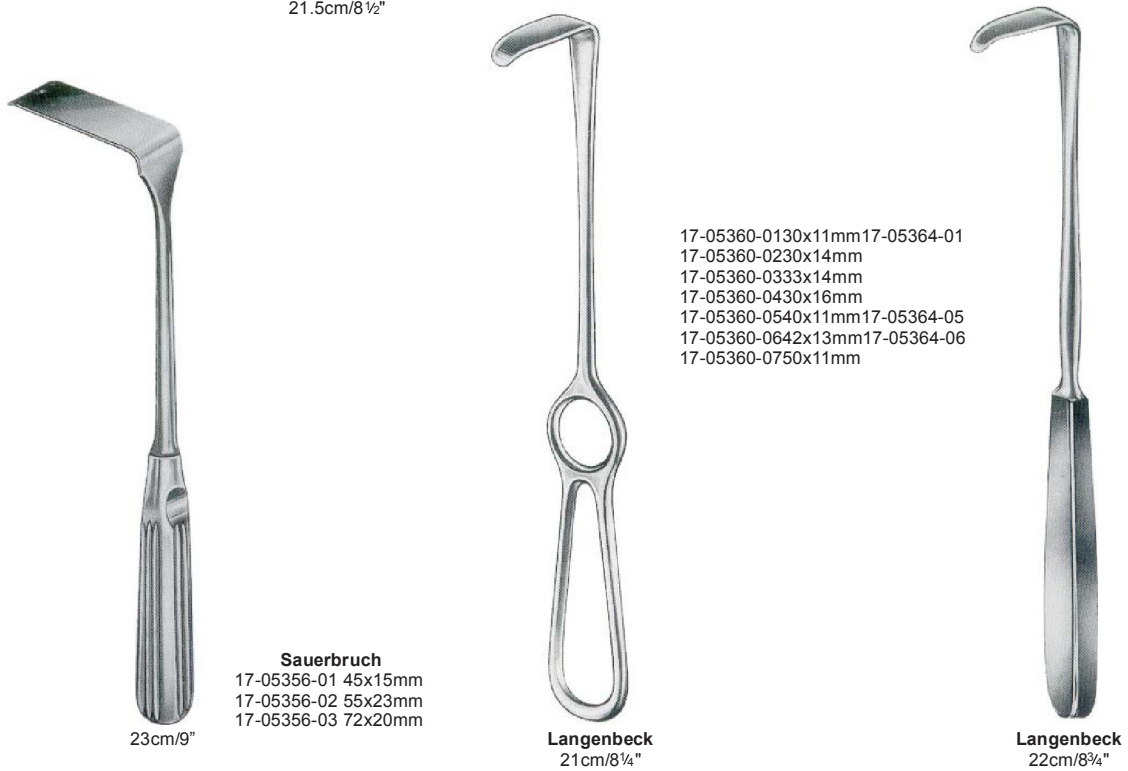
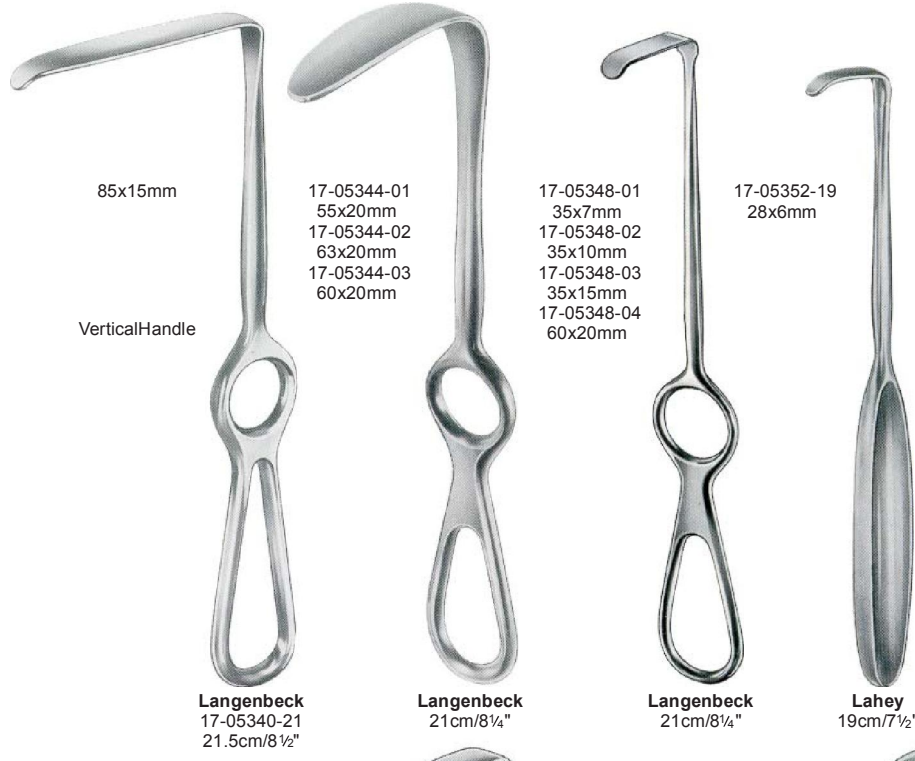



38x20mm

**Kocher**  
17-05368-22  
22cm/8¾"

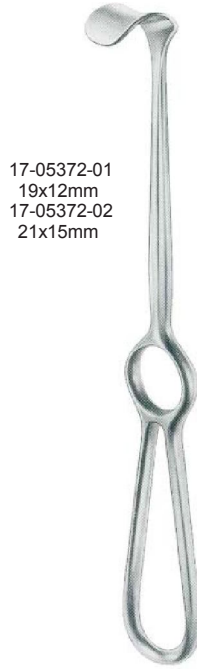

17-05372-01  
19x12mm  
17-05372-02  
21x15mm

**Kocher**  
19cm/7½"

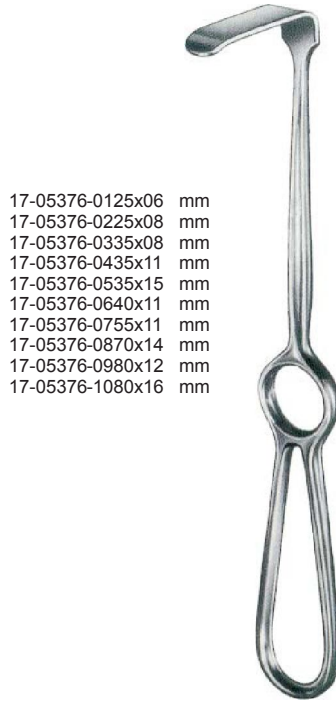

17-05376-0125x06 mm  
17-05376-0225x08 mm  
17-05376-0335x08 mm  
17-05376-0435x11 mm  
17-05376-0535x15 mm  
17-05376-0640x11 mm  
17-05376-0755x11 mm  
17-05376-0870x14 mm  
17-05376-0980x12 mm  
17-05376-1080x16 mm

**Kocher-Langenbeck**  
21.5cm/8½"



67x17cm

**Casper**  
17-05380-21  
21.5cm/8½"

17-05388-01  
22x15mm



17-05388-02  
38x20mm



17-05388-03  
67x25mm



17-05388-04  
100x35mm



17-05384-01  
40x18mm  
17-05384-02  
60x20mm  
17-05384-03  
60x25mm  
17-05384-04  
75x30mm  
17-05384-05  
75x40mm

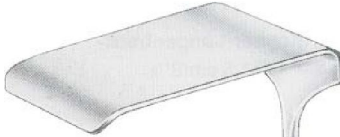

**Kocher**  
23cm/9"



**Kocher-Wagner**  
28cm/11"



17-05392-01  
60x20mm  
17-05392-02  
80x30mm  
17-05392-03  
100x30mm  
17-05392-04  
120x30mm  
17-05392-05  
140x30mm  
17-05392-06  
140x40mm



**Heosel**  
25cm/10"





130x60mm

**St.Marks**  
17-05396-29  
29cm/11½"

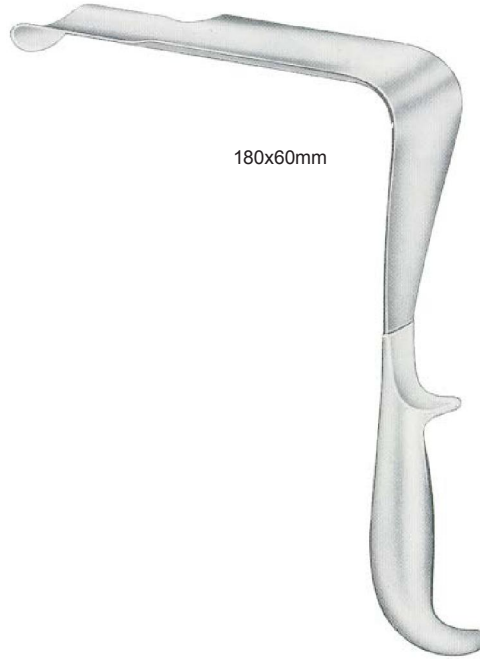

180x60mm

**St.Marks**  
17-05396-32  
32.5cm/12¾"



180x60mm

**St.Marks**  
17-05396-33  
33cm/13"



17-05400-01  
70x40mm  
17-05400-02  
70x50mm  
17-05400-03  
70x65mm

**Morris**  
21cm/8¼"



17-05402-01  
32x50mm/38x50mm  
17-05402-02  
45x50mm/50x50mm  
17-05402-03  
65x50mm/38x50mm

**Morris**  
24cm/9½"



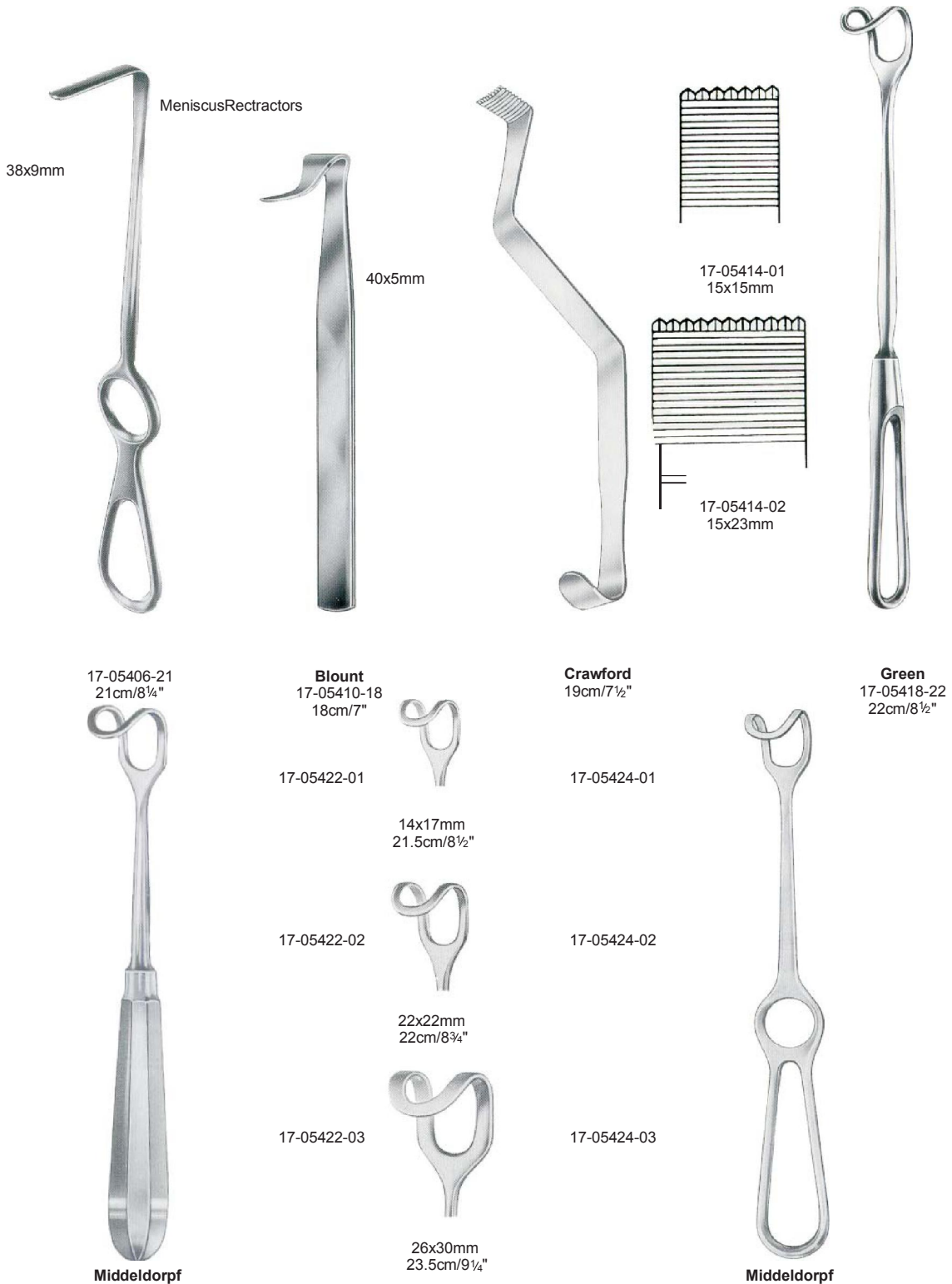



17-05426-01  
45x45mm

**Middeldorpf**  
25.5cm/10"

- 17-05426-01  
45x45mm
- 17-05426-02  
45x50mm
- 17-05426-03  
55x70mm



**Richardson**  
26cm/10¼"



17-05430-01  
28x20mm

17-05430-02  
30x28mm

17-05430-03  
38x37mm

17-05430-04  
52x22mm

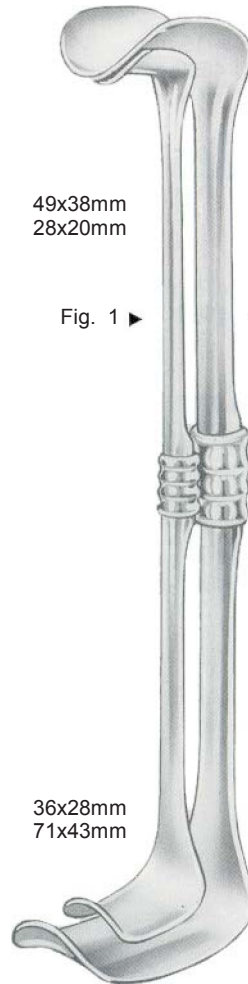

49x38mm  
28x20mm

Fig. 1 ▶

36x28mm  
71x43mm

**Richardson-Eastman**

Set 17-05434-00

Fig. 1  
26cm/10¼" 17-05434-01

Fig. 2  
28cm/11" 17-05434-02



**Kelly**  
26cm/10¼"

- 17-05438-01  
40x50mm
- 17-05438-02  
50x65mm
- 17-05438-03  
65x75mm
- 17-05438-04  
75x90mm

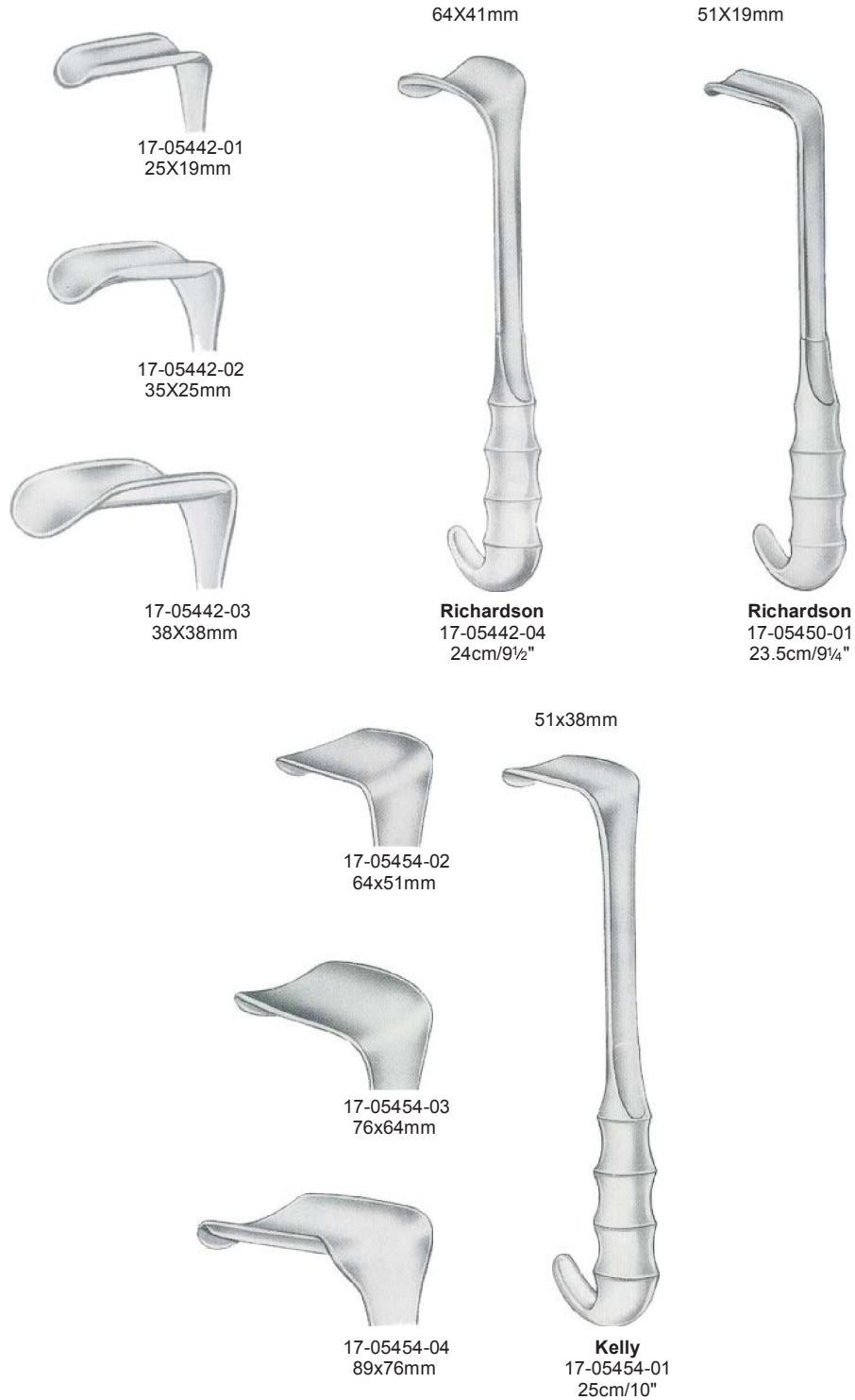



17-05458-01  
45x40mm  
17-05458-02  
45x50mm  
17-05458-03  
45x60mm  
17-05458-04  
45x75mm  
17-05458-05  
65x85mm

**Fritsch**  
24cm/9½"

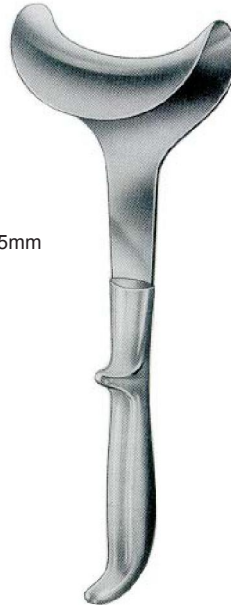

50x85mm

**Doyen**  
17-05462-25  
25cm/10"



17-05466-01  
15x90mm  
17-05466-02  
20x90mm  
17-05466-03  
30x90mm  
17-05466-04  
35x110mm  
17-05466-05  
40x110mm  
17-05466-06  
55x120mm

**Doyen-Stille**  
24cm/9½"



70x25mm

**Kocher**  
17-05470-22  
22.5cm/9"

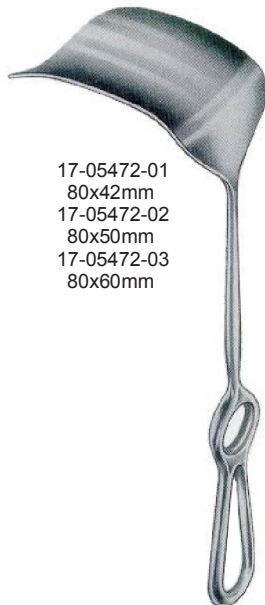

17-05472-01  
80x42mm  
17-05472-02  
80x50mm  
17-05472-03  
80x60mm

**Kocher**  
25cm/10"



60x60mm

**Tuffier**  
17-05476-23  
23cm/9"



17-05480-01  
115x22mm  
17-05480-02  
115x27mm

**Simon**  
28cm/11"

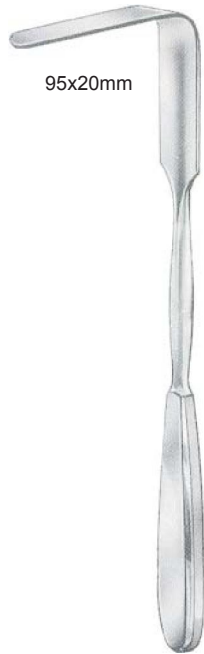

95x20mm

**Tubingen**  
17-05484-28  
28cm/11"



105x27mm

**Martin**  
17-05488-26  
26cm/10¼"



17-05492-01  
80x20mm  
17-05492-02  
100x25mm  
17-05492-03  
120x25mm  
17-05492-04  
130x30mm  
17-05492-05  
140x20mm  
17-05492-06  
160x30mm  
17-05492-07  
180x30mm

**Brunner**  
25cm/10"

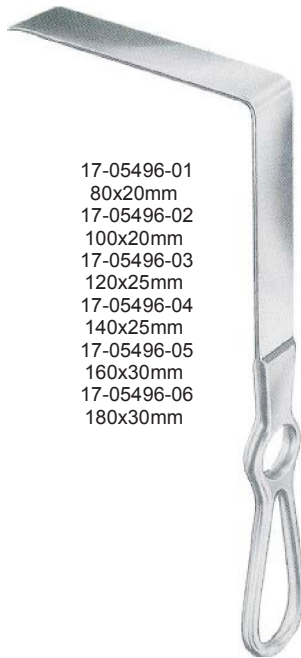

17-05496-01  
80x20mm  
17-05496-02  
100x20mm  
17-05496-03  
120x25mm  
17-05496-04  
140x25mm  
17-05496-05  
160x30mm  
17-05496-06  
180x30mm

**Brunner**  
25cm/10"



17-05500-01  
85x35mm  
17-05500-02  
120x50mm  
17-05500-03  
155x50mm

**Mikulicz**  
26cm/10¼"



90x50mm

**Mikulicz**  
17-05502-26  
26cm/10¼"



17-05506-01  
160x38mm  
17-05506-02  
160x57mm  
17-05508-01  
190x38mm  
17-05508-02  
190x57mm

**Kelly**  
27cm/10½"



**Polloson**  
17-05510-27  
27cm/10½"



**Polloson**  
17-05512-27  
27cm/10½"



17-05516-03  
115x65mm

17-05516-02  
115x38mm

17-05516-01  
82x20mm

**Coryllos**  
23.0cm/9"

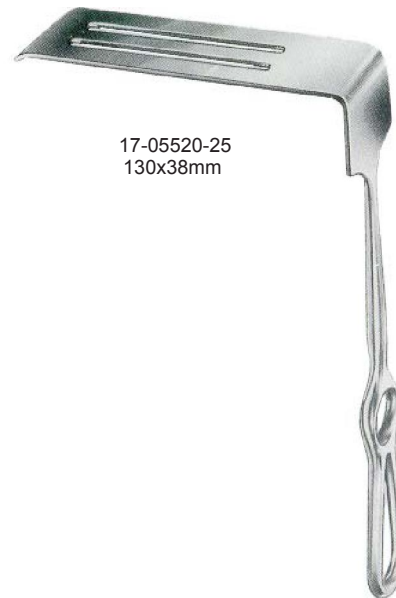

17-05520-25  
130x38mm

**Sauerbruch**  
25cm/10"



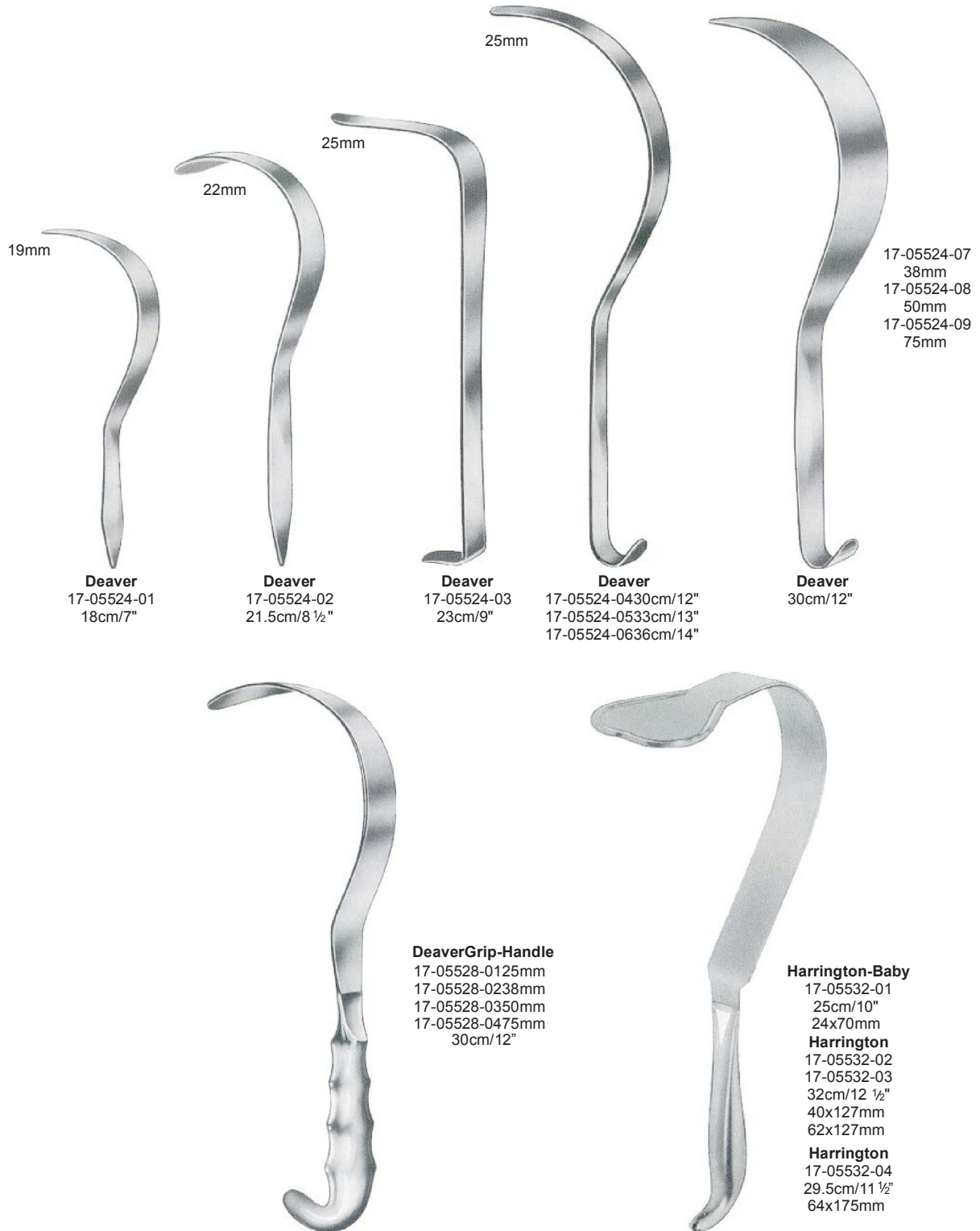



17-05536-01  
50x16mm  
17-05536-02  
75x25mm  
17-05536-03  
90x50mm

**Meyerding**  
22.5cm/9"



**Zenker**

17-05540-01 25cm/10" 35x08mm  
17-05540-02 26cm10¼" 60x12mm  
17-05540-03 27.5cm/10¾" 75x12mm

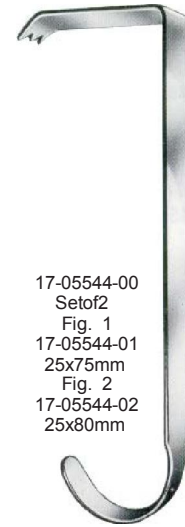

17-05544-00  
Setof2  
Fig. 1  
17-05544-01  
25x75mm  
Fig. 2  
17-05544-02  
25x80mm

**Hibbs**  
24cm/9½"

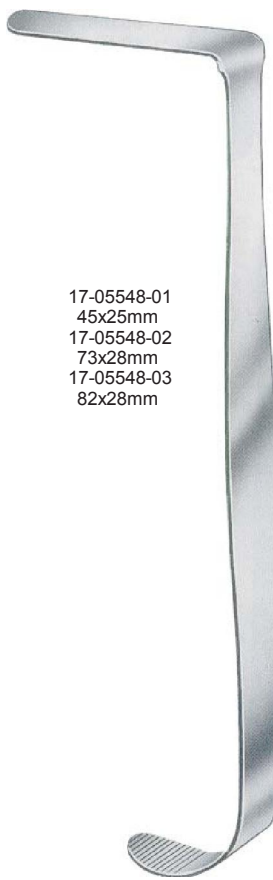

17-05548-01  
45x25mm  
17-05548-02  
73x28mm  
17-05548-03  
82x28mm

**Heaney**  
27cm/10½"

46mm



**Kuemmel**  
17-05552-33  
33cm/13"



100x45mm

rigid

**Koerte**  
17-05556-28  
28cm/11"

17-05560-20  
20mm  
17-05560-30  
30mm  
17-05560-40  
40mm



**Kader**  
27cm/10½"



17-05564-01  
25.5cm/10"  
45mm  
17-05564-02  
27.5cm/10¾"  
60mm

**Leriche**



**Malleable**  
17-05568-01 20mm  
17-05568-02 25mm  
17-05568-03 30mm  
17-05568-04 35mm  
17-05568-05 40mm  
17-05568-06 45mm  
17-05568-07 50mm  
17-05568-08 64mm  
17-05568-09 76mm  
17-05568-10/102mm  
33cm/13"

Malleable



**Tuffier**  
17-05570-20  
20cm/8"  
17x25mm

Malleable

17-05572-01  
200x6mm  
17-05572-02  
200x8mm  
17-05572-03  
200x10mm  
17-05572-04  
200x12mm  
17-05572-05  
200x17mm  
17-05572-06  
200x20mm  
17-05572-07  
200x25mm  
17-05572-08  
250x25mm



20cm/8"

Malleable

17-05574-01  
280x25/30mm  
17-05574-02  
300x37/45mm  
17-05574-03  
300x40/50mm



**Haberer**  
21cm/8¼"



**Reverdin**  
17-05578-28  
28cm/11"



**Davidson**  
16cm/6¼"  
75x50mm  
75x90mm  
17-05582-01  
17-05582-02

**Cooley**  
17-05586-01  
21.5cm/8½"

**Cooley**  
17-05586-02  
21.5cm/8½"

**Cooley**  
17-05586-03  
23cm/9"



**Ross**  
27cm/10½"

- Fig. 1 17-05590-01 13x13mm
- Fig. 2 17-05590-02 14x12mm
- Fig. 3 17-05590-03 18x18mm
- Fig. 4 17-05590-04 20x20mm
- Fig. 5 17-05590-05 22x18mm
- Fig. 6 17-05590-06 26x24mm

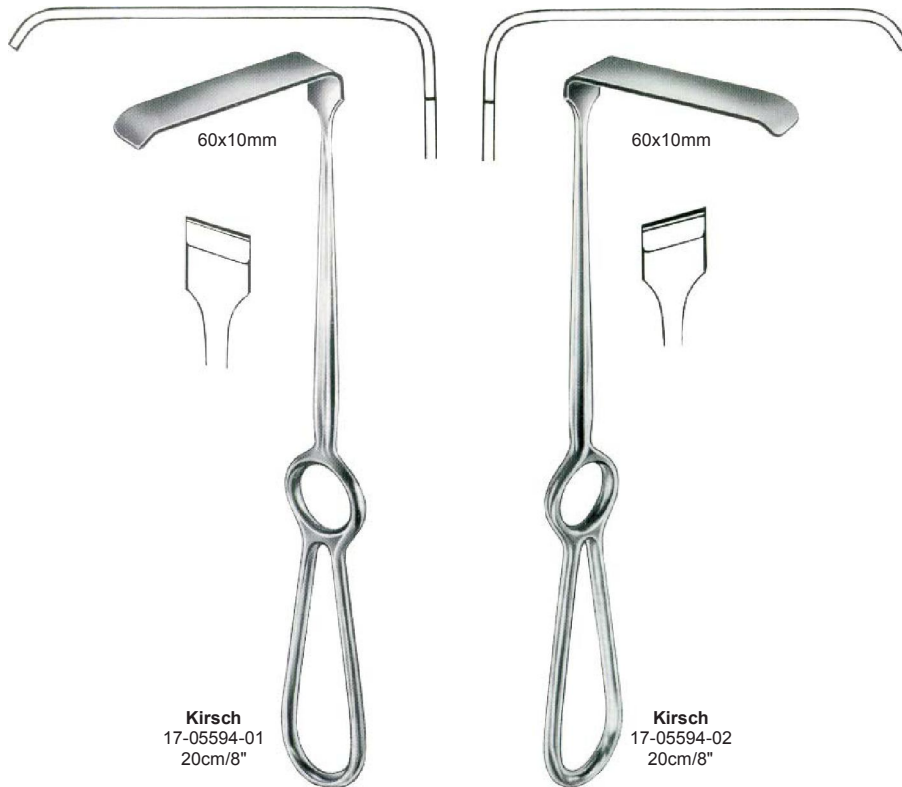



22cm/8¾"



17-05608-01  
25x7mm



17-05608-02  
31x10mm

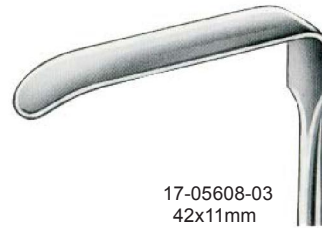

17-05608-03  
42x11mm



17-05608-04  
55x12mm



17-05608-05  
70x14mm

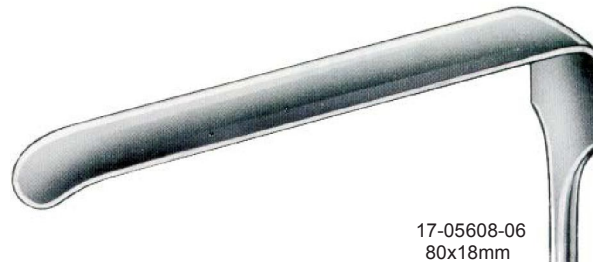

17-05608-06  
80x18mm





22cm/8¾"



17-05612-01  
42x13mm



17-05612-02  
60x12mm



17-05612-03  
80x16mm



**Spina-Nasalis**  
17-05616-01  
22cm/8 3/4"

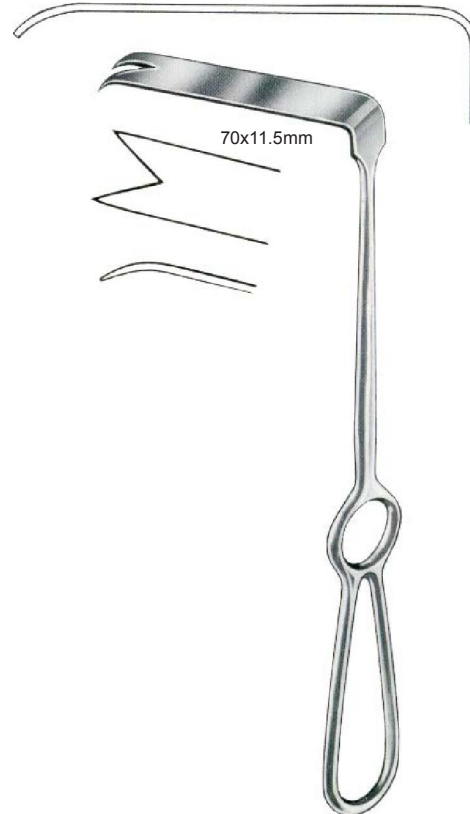

**Ramus**  
17-05616-02  
22cm/8 3/4"



17-05620-15  
15.5cm/6"



17-05624-16  
16cm/6 1/4"



17-05627-10 10mm  
17-05627-20 20mm  
19cm/7½"



**Dingman**  
17-05629-17  
17.5cm/7"



**Soeresen-Hein**  
17-05632-17  
17.5cm/7"



**Dingman**  
17-05636-21  
21cm/8¼"



17-05640-18  
18.5cm/7¼"

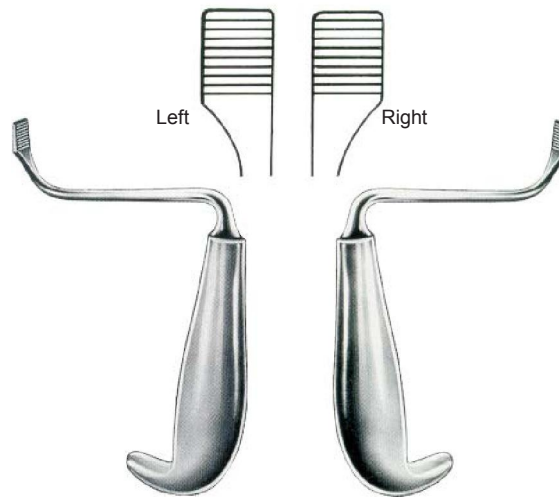

**Tessier**  
17-05644-01  
15cm/6"

**Tessier**  
17-05646-02  
15cm/6"



**Dingman**  
17-05648-00

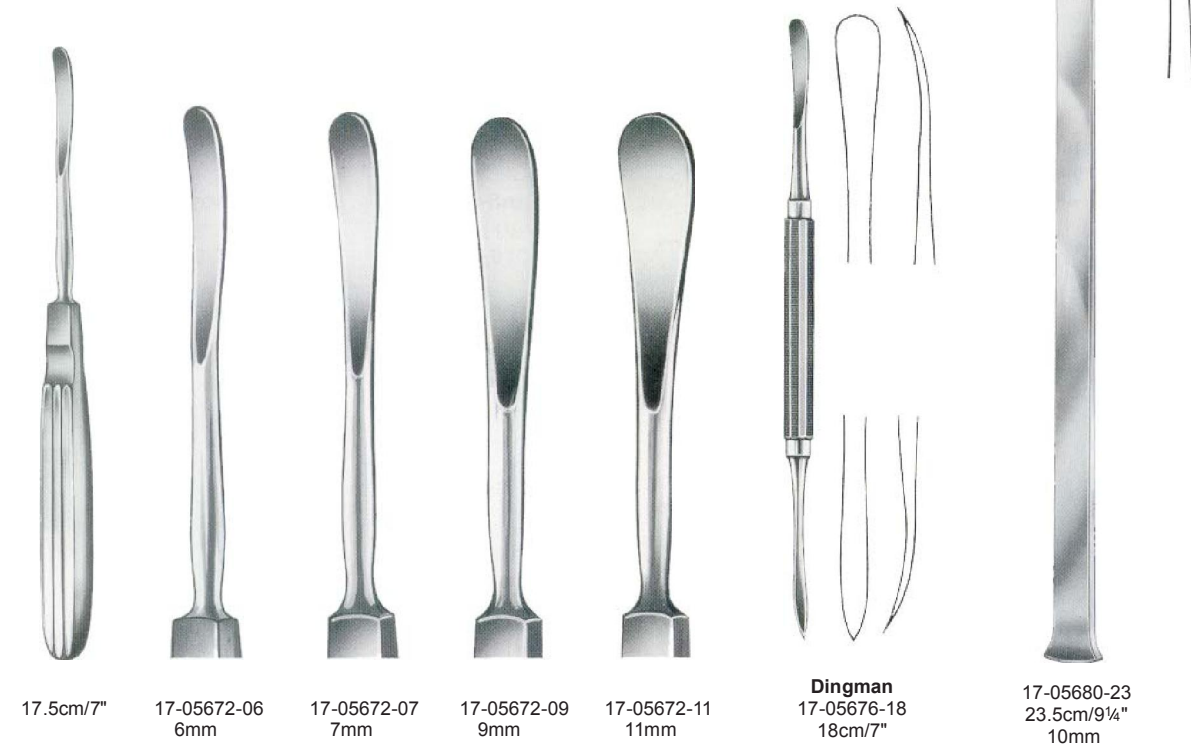
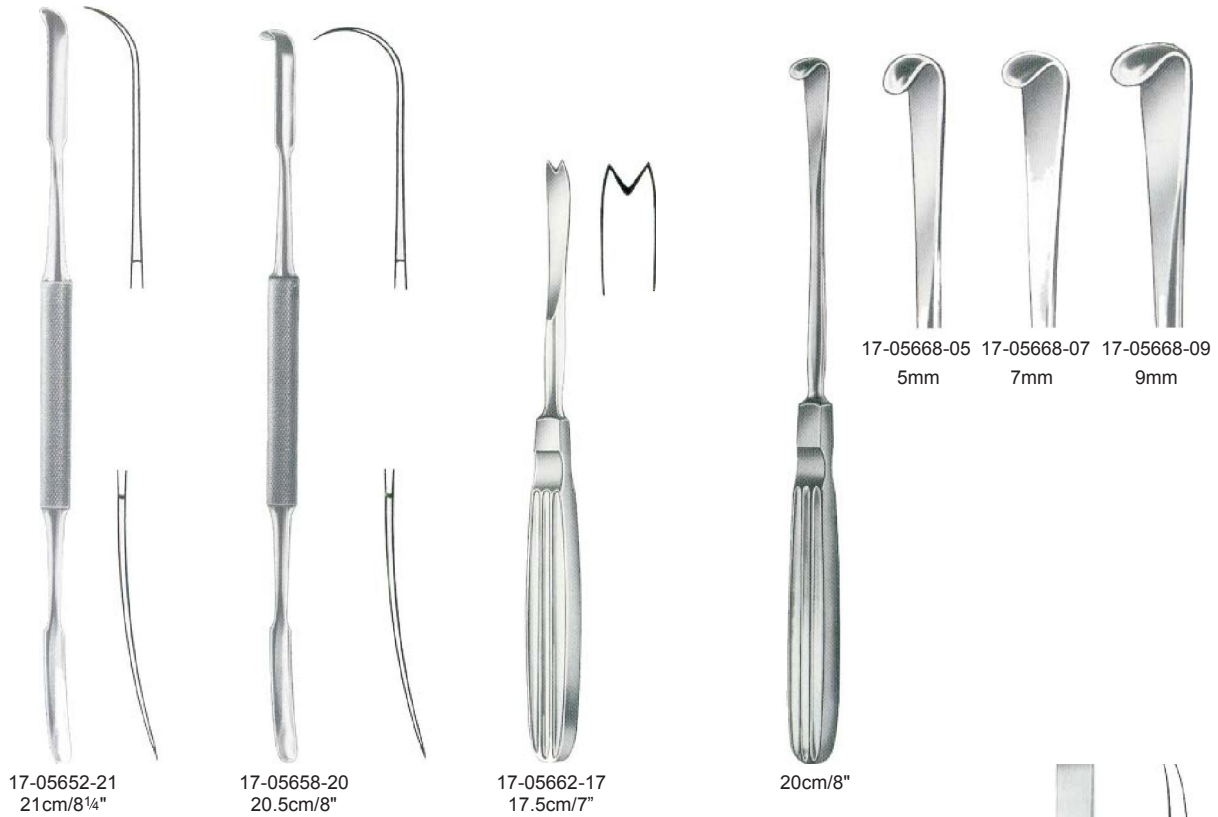



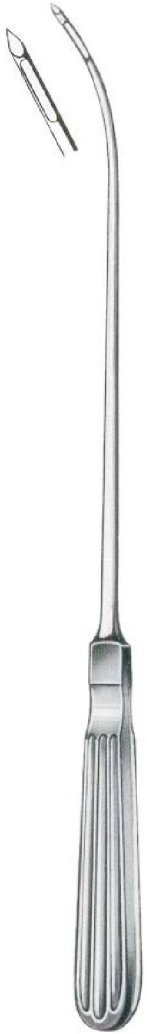

**Sanders-Brown**  
17-05712-30  
30cm/12"



**Sanders-Brown**  
17-05716-29  
29cm/11½"



17-05720-14  
14cm/5½"



17-05722-23  
23cm/9"



17-05724-18  
18cm/7"



**Kelsey-Fry**  
17-05726-15  
15cm/6"



**Kelsey-Fry**  
17-05728-18  
18cm/7"



**Mershon**  
17-05732-14  
14.5cm/5½"





**Bose**



**Finsen**

Sharp



**Finsen**

Blunt

Sharp

cm	in				
5	2		17-05739-05		17-05740-05
7	2¾"	17-05736-07	17-05739-07	17-05740-07	17-05743-07

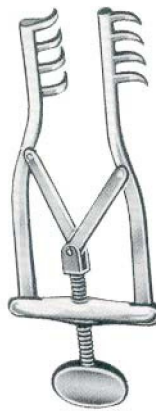

**Allport**

17-05750-09  
9.5cm/3¾"

Sharp



**Alm**

Blunt

cm	in		cm	in		
8.5	3 ½"	17-05746-08	7	2¾"	17-05753-07	17-05756-07
11.5	4 ½"	17-05746-11	10	4	17-05753-10	17-05756-10



**Holzheimer**  
 Sharp 17-05759-10 10cm/4"  
 blunt 17-05760-10



**Jansen**  
 Sharp 17-05763-10 10.5cm/4 1/4"  
 blunt 17-05764-10



**Jansen-Deep**  
 Sharp 17-05767-10 10.5cm/4 1/4"  
 blunt 17-05768-10



**Plester**  
 17-05772-11  
 11.5cm/4 1/2"



**Plester**  
 17-05774-11  
 11.5cm/4 1/2"



Sharp 17-05777-13 **Plester**  
 blunt 17-05778-13



**Weitlaner**

Sharp Blunt

10.5cm/4 1/4"	17-05781-10	17-05782-10
13.0cm/5"	17-05781-13	17-05782-13
14.0cm/5 1/2"	17-05781-14	17-05782-14
16.5cm/6 1/2"	17-05781-16	17-05782-16



**Weitlaner**

Sharp Blunt

17-05785-13	17-05786-13
17-05785-14	17-05786-14
17-05785-16	17-05786-16



**Weitlaner-Wullstein**

Sharp Blunt

17-05789-13	17-05790-13
17-05789-14	17-05790-14
17-05789-16	17-05790-16



**Mollison**  
17-05793-15  
15cm/6"



**Tuebinger-Modell**  
17-05796-16  
16cm/6 1/4"



**Henner(Lempert)**  
17-05800-12  
12cm/4 1/2"

Completerwith2pairs of bladesandcentreblade

Completo with 3 Central blades

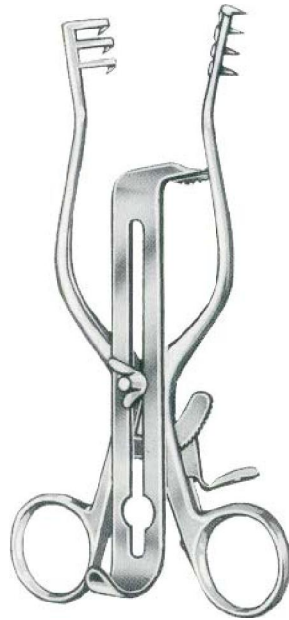

**Henley**

Sharp		Blunt
17-05803-16	16.5cm/6 1/2"	17-05804-16

Central blades, only



17-05805-19	17-05805-25	17-05805-32
16x19mm	16x25mm	16x32mm



**Weitlaner-Baby**

13cm/5"	17-05808-13
16cm/6 1/4"	



**Milligan**

Sharp	Blunt
17-05811-13	17-05812-13



**Cone (Adson-Baby)**

Sharp	Blunt
17-05815-13	17-05816-13
17-05815-16	17-05816-16



**Weitlaner**



3x4Teeth



5x6Teeth

	Sharp	Blunt	Sharp	Blunt
20cm/8"	17-05819-20	17-05820-20		
25cm/10"	17-05819-25	17-05820-25	17-05821-25	17-05822-25



**Adson**



**Anderson-Adson**



**Cone**

	Sharp	Blunt	Sharp	Blunt	Sharp	Blunt
20cm/8"	17-05823-20	17-05824-20	17-05827-20	17-05828-20	17-05831-20	17-05832-20
26cm/10 1/4"	17-05823-26	17-05824-26			17-05831-26	17-05832-26





**Travers**  
17-05836-21  
21cm/8 1/4"

**JawsDepth**

25mm	17-05839-01
44mm	17-05839-02



**Beckmann-Adson**  
31cm/12 1/4"

Sharp	17-05840-01	Blunt	17-05840-02
-------	-------------	-------	-------------



**Adson**  
27cm/10 1/2"

Sharp 17-05843-27  
Blunt 17-05844-27



5x6Teeth



**Adson**

Sharp 17-05847-27 27cm/10½"  
Blunt 17-05848-27



**Beckmann-Adson  
(Standard)**

Sharp 17-05851-31 31cm/12¼"  
Blunt 17-05852-31



**Adson**

17-05856-33 33cm/13"

Hemilaminectomy Retractor



17-05861-27  
27cm/10½"



**Beckmann-Eaton**  
17-05864-33  
33cm/13"

Retractor Only  
17-05868-01

Lateral Blades  
17-05868-02



**Collin**  
17-05868-00  
20cm/8"



**Baby-Collin**  
17-05872-00

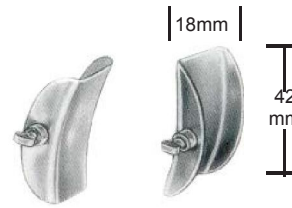

17-05872-01



**Collin**  
20cm/8"

	Fig. 1	Fig. 2	Fig. 3
Retractors Complete	17-05876-00	17-05878-00	17-05880-00
Retractors Only	17-05876-01	17-05878-01	17-05880-01
Lateral Blades	17-05876-02 38x62mm	17-05878-02 38x80mm	17-05880-02 38x100mm
Central Blades	17-05876-03 55x55mm		17-05880-03 55x75mm

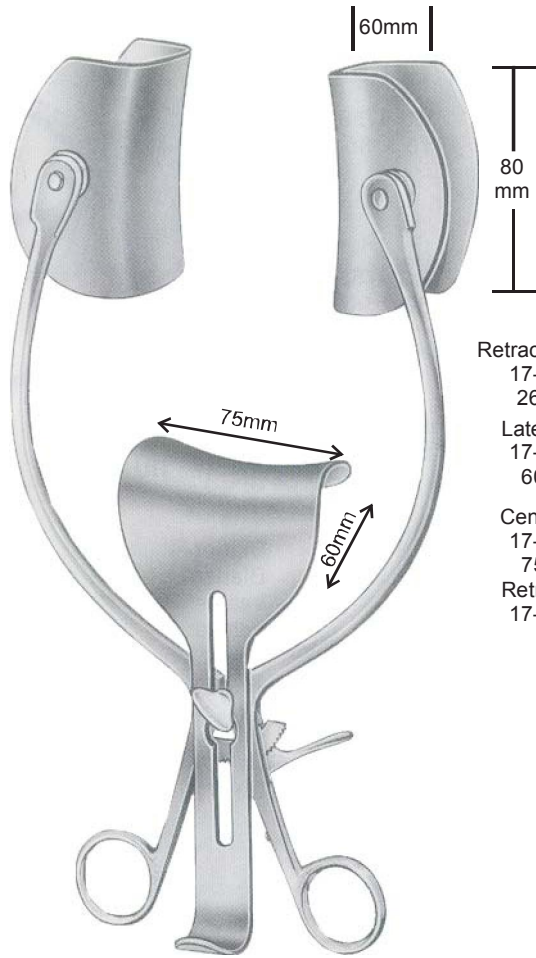

**Collin**

- Retractor Complete  
17-05884-00  
26cm/10½"
- Lateral Blades  
17-05884-01  
60X80mm
- Central Blades  
17-05884-02  
75X60mm
- Retractor Only  
17-05884-03



**Mayo-Adams**  
17-05886-01  
17cm/6¾"

**Mayo-Adams**  
17-05886-02  
17cm/6¾"

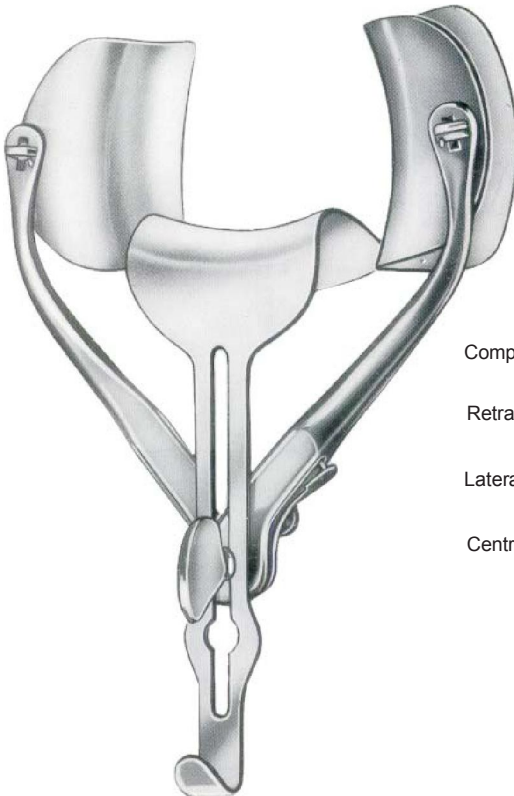

**Ricard**  
17-05890-00 28cm/11"  
17-05894-00 30cm/12"

Complete	Fig. 1 17-05890-00	Fig. 2 17-05894-00
RetractorsOnly	17-05890-01	17-05894-01
LateralBlades	17-05890-02 60x80mm	17-05894-02 75x85mm
CentralOnly	17-05890-03 53x70mm	17-05894-03 80x90mm

VulvalRetractor



**Richter**  
17-05898-16  
16.5cm/6 1/2"



**Gelpi**  
17-05902-09 9cm/3 1/2"  
17-05902-11 11cm/4 1/2"  
17-05902-13 13cm/5"  
17-05902-19 19cm/7 1/2"



**Gelpi**  
17-05904-19  
19cm/7 1/2"



**Meyerding**  
Fig. 117-05908-01  
Fig. 217-05908-02  
Fig. 317-05908-03  
Fig. 417-05908-04  
18cm/7"

Blades

- Fig. 1 1 3/4"x1"
- Fig. 2 2 1/8"x1"
- Fig. 3 2 3/8"x1 3/4"
- Fig. 4 2 3/8"x1"





**Markham-Meyering**

17-05912-18 18cm/7" 17-05914-18

**Rigby**

17-05918-19  
19cm/7½"

**DeBakey**

17-05922-12 12cm/4¾"  
17-05922-17 17cm/6¾"

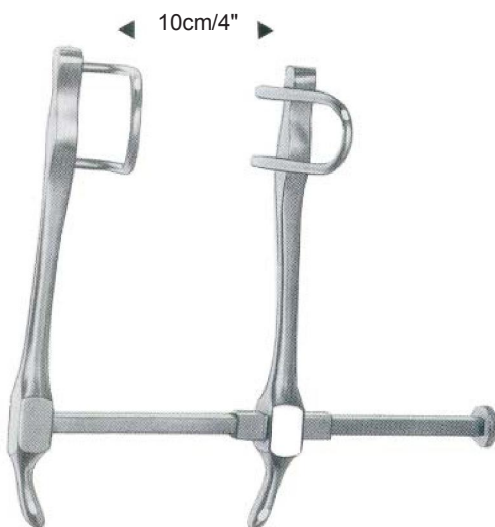

**Gosset**  
17-05926-00

Fig.1 ◀ 10cm/4" ▶  
Fig.2 ◀ 14cm/5½" ▶



**Gosset**  
Fig.1 17-05928-01  
Fig.2 17-05928-02





Retractors Only  
17-05932-01

Central Blade  
17-05932-02  
56X60mm

**Gosset**  
17-05932-00

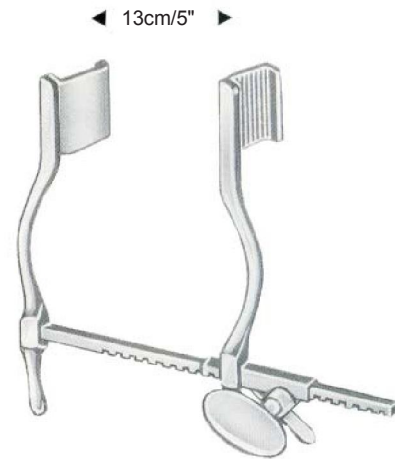

**Hertzer**  
17-05936-00

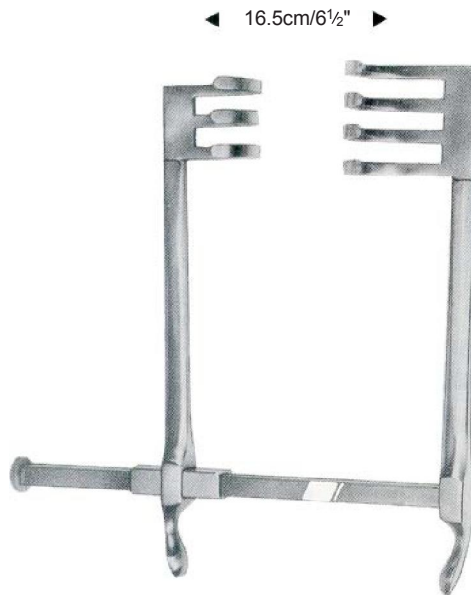

**Frazier**  
17-05940-00

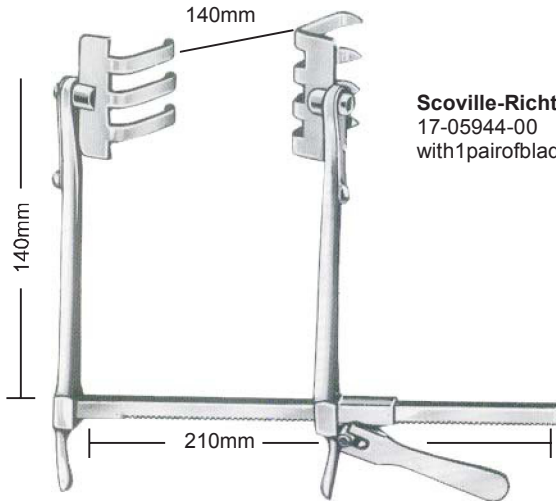

**Scoville-Richter**  
17-05944-00  
with 1 pair of blades 17-05944-01

the blades are available by pairs

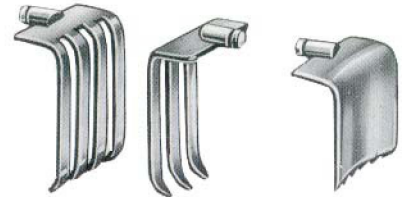

17-05944-01  
60x50mm

17-05944-02  
48x50mm



17-05944-03  
28x40mm



17-05944-04  
38x62mm

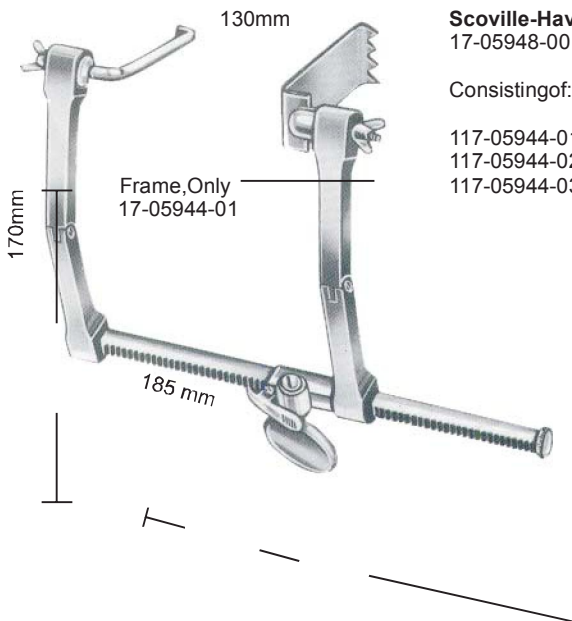

**Scoville-Haverfield**  
17-05948-00

Consisting of:

- 117-05944-01
- 117-05944-02
- 117-05944-03

Frame, Only  
17-05944-01



**Scoville**  
17-05948-02  
51mm



**Scoville**  
17-05948-03 63x25mm  
17-05948-04 63x51mm  
17-05948-05 67x32mm  
17-05948-06 89x25mm



**Taylor**  
17-05948-07  
48x38mm



**Taylor**  
17-05948-08 63x51mm  
17-05948-09 79x57mm

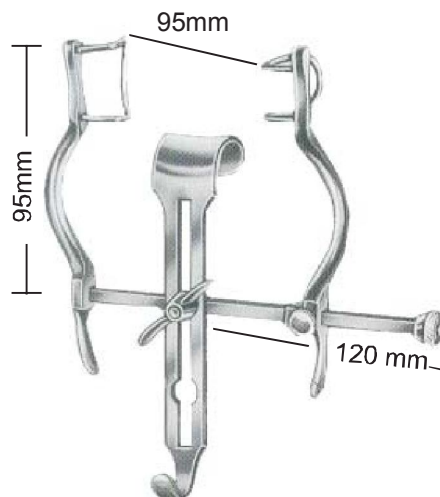

**Baby-Balfour**  
17-05952-00

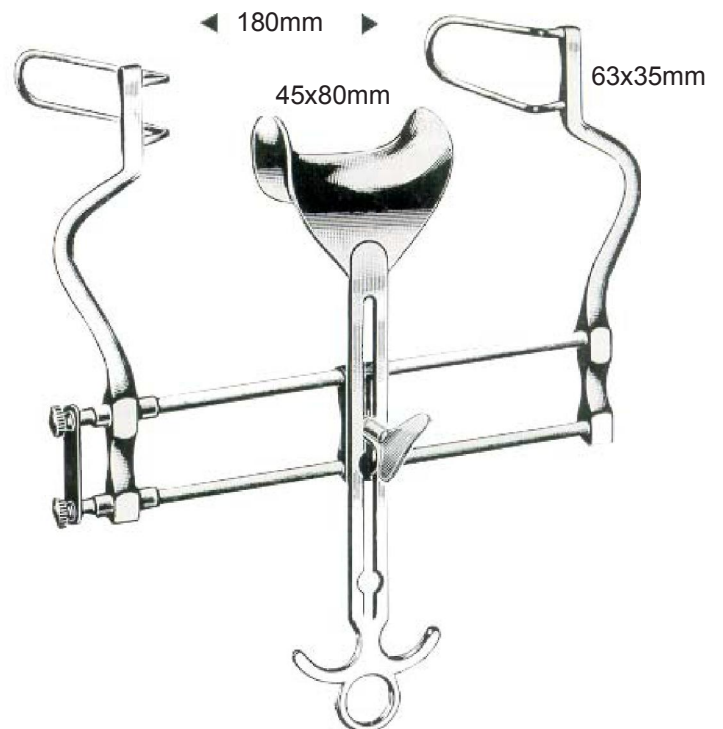

**Balfour**  
17-05956-00

RetractorComplete

RetractorOnly

CentralBladeOnly

17-05952-01

17-05952-02

17-05956-01

17-05956-02



RetractorComplete  
17-05960-00

RetractorOnly  
17-05960-01

CentralBladeOnly  
17-05960-02

Retractor,Complete  
17-05964-00

RetractorOnly  
17-05964-01

CentralBladeOnly  
17-05964-02

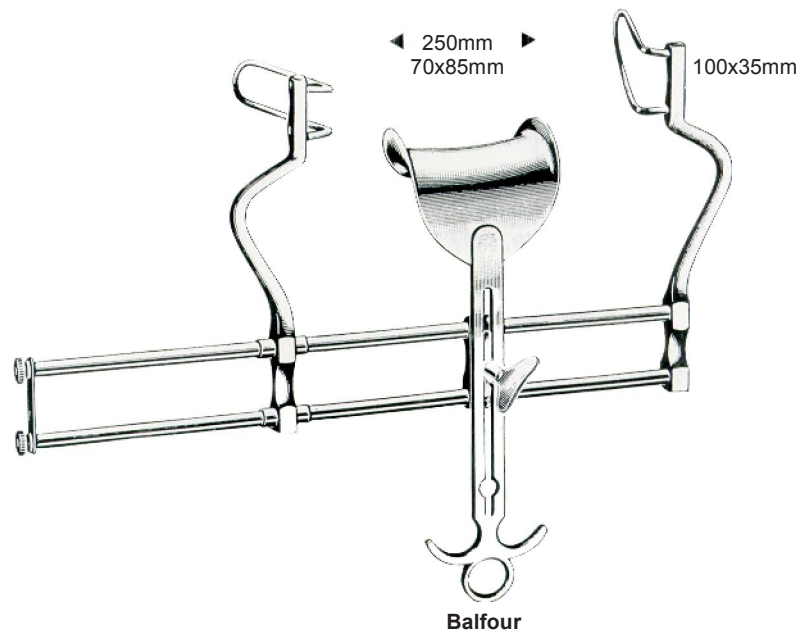



**Balfour**

- Retractor, complete  
17-05968-00
- Retractor, only  
17-05968-01
- Centralblade, only  
17-05968-02

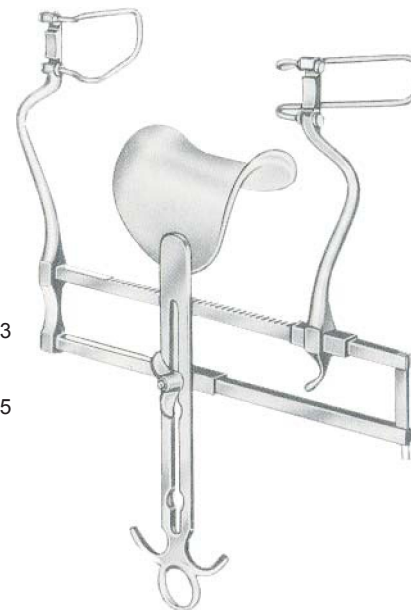

**BalfourUSA-Modell**

Retractor, complete  
17-05972-00

Retractor, only  
17-05972-01

Centralblade, only  
17-05972-02  
45x68mm

Lateralblades, only  
17-05972-04  
60mm

17-05972-03  
68x85mm

17-05972-05  
80mm

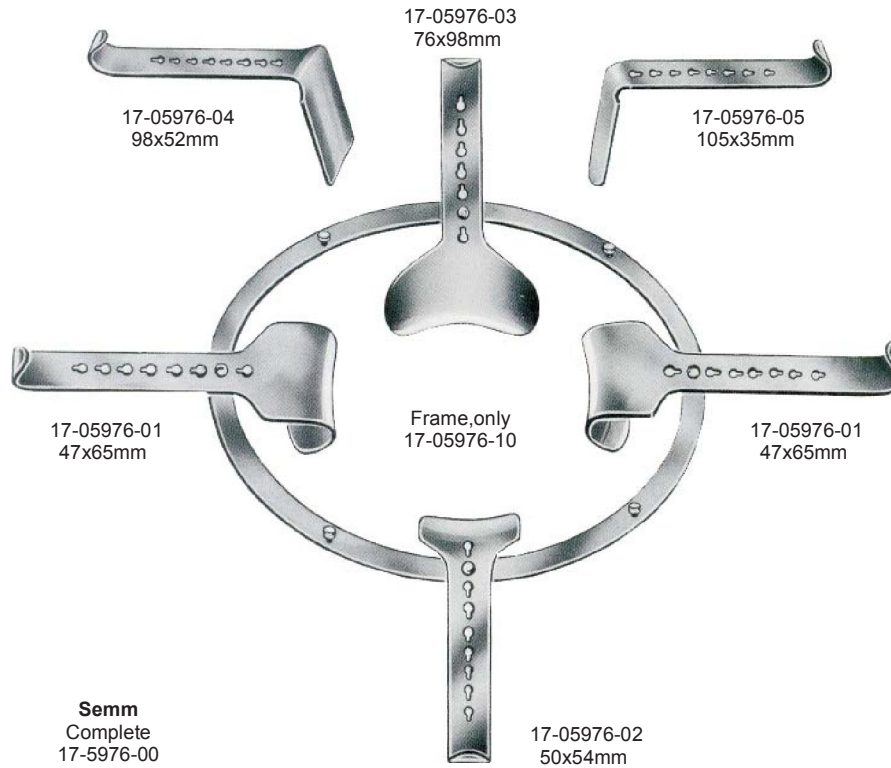



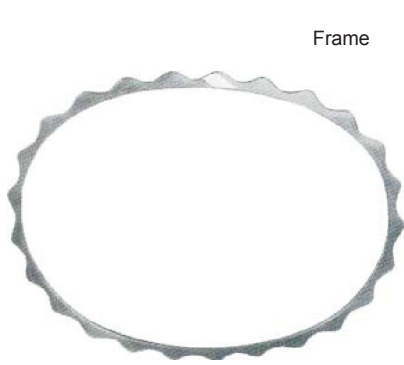

Frame

17-05988-10 178x140mm  
17-05990-20 255x178mm



Fig.1 17-05988-01 38x38mm  
Fig.2 17-05988-02 38x25mm

Complete  
17-05988-00  
17-05990-00

**Denis-Brown**  
Consisting of

1x 17-05988-10  
1x 17-05990-20

2x 17-05988-01  
2x 17-05988-01

2x 17-05988-02  
2x 17-05988-02



110x70mm

**O'Sullivan-O'Connor**  
Complete  
17-05994-00



17-05994-01  
80x45mm



17-05994-02  
80x45mm



17-05994-03  
110x70mm

17-05998-01 38x60mm  
17-05998-02 45x80mm

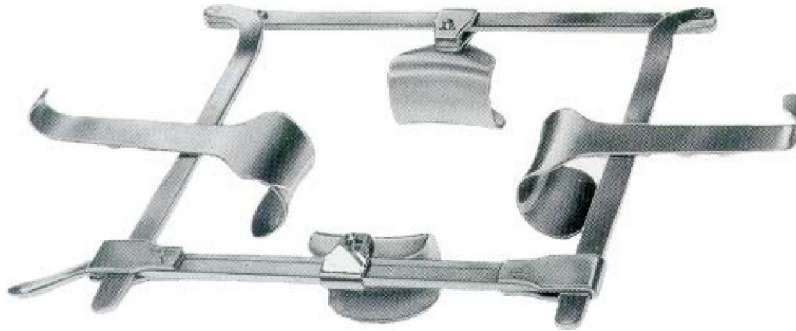

17-05998-03 50x65mm  
17-05998-04 60x85mm

FoldableFrame  
17-05998-10

### Franz

Completo with 4 valves  
17-5998-00

With con  
17-05998-10 1x  
17-05998-01 2x  
1705998-03 2x

Completo with 8 valves  
17-5999-00

With con  
17-05998-10 1x  
17-05998-01 2x  
1705998-02 2x  
17-05998-03 2x  
17-05998-04 2x



17-06002-01 48x90mm  
17-06002-02 48x105mm  
17-06002-03 48x120mm  
17-06002-04 48x135mm

**Doyen**  
28cm/11"



cm	In	1.0mm Ø	1.5mm Ø	2.0mm Ø	2.0mm Ø	Watson-Cheyne	Fish
11.5	4 1/2"	18-06004-11	18-06006-11	18-06008-11			
13	5"	18-06004-13	18-06006-13	18-06008-13			
14.5	5 3/4"	18-06004-14	18-06006-14	18-06008-14	18-06010-14	18-06012-14	18-06020-14
16	6 1/4"	18-06004-16	18-06006-16	18-06008-16	18-06010-16	18-06012-16	
18	7"	18-06004-18	18-06006-18	18-06008-18		18-06012-18	18-06020-18
20	8"	18-06004-20	18-06006-20	18-06008-20		18-06012-20	
25	10"	18-06004-25	18-06006-25	18-06008-25			



cm	In				Nelaton	Stacke 1.0mm Ø	Brodie
10.5	4 1/4"					18-06036-10	
11.5	4 1/2"	18-06024-11					
13	5"	18-06024-13		18-06028-13	18-06032-13		
14.5	5 3/4"	18-06024-14	18-06025-14	18-06028-14	18-06032-14		
16	6 1/4"	18-06024-16		18-06028-16	18-06032-16	18-06033-16	18-06040-16
18	7"	18-06024-18		18-06028-18			
20	8"	18-06024-20			18-06032-20		

Oftin



18-06044-25 25cm/10"  
18-06044-30 30cm/12"  
18-06044-40 40cm/15 3/4"

Plasterspatulas



18-06048-13 13cm/5"  
18-06048-14 14cm/5 1/2"

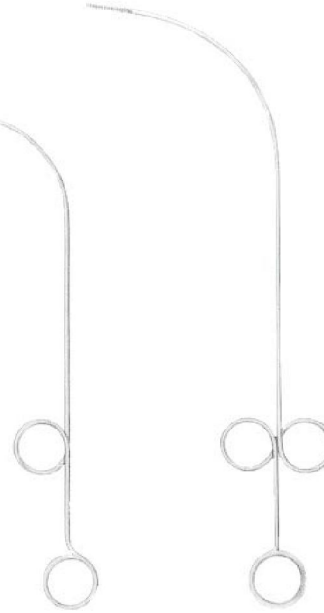

**Pelteson**  
18-06052-23  
23cm/9"

**Fein**  
18-06054-28  
28cm/11"



**Buie**  
18-06058-16  
16cm/6 1/4"

Fistulaprobes



**Lockhart-Mummary**  
16.5cm/6 1/2"



Fig.1  
18-6062-01



Fig.2  
18-6062-02

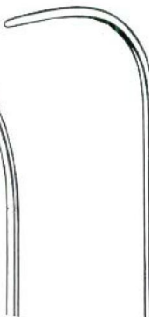

Fig.3  
18-6062-03



Fig.4  
18-6062-04



**Pratt**  
21cm/8 1/4"



18-06070-01



18-06070-02



18-06070-03



**Universal**

cm	in	1.2mm Ø	1.5mm Ø	1.7mm Ø
12.5	5"	18-06074-12		
16	6¼"	18-06074-16		
18	7"	18-06074-18	18-06075-18	18-06076-18



**Uckermann**  
18-06078-16  
16cm/6 ¼"



**Jobson-Horne**  
18-06080-1313cm/5"  
18-06080-1818cm/7"



Round      Triangular

**Farrell  
(Farrell-Lathbury)**

cm	in	0.9mm Ø	1.1mm Ø	1.2mm Ø	1.5mm Ø
12	4¾"				
14	5½"			18-06084-14	18-06086-14
16	6¼"			18-06084-16	18-06086-16
18	7"				



Round      Triangular

1.2mm Ø	1.5mm Ø	1.5mm Ø
18-06090-12	18-06092-12	18-06094-12
18-06090-14	18-06092-14	18-06094-14
18-06090-16	18-06092-16	18-06094-16
18-06090-18	18-06092-18	18-06094-18

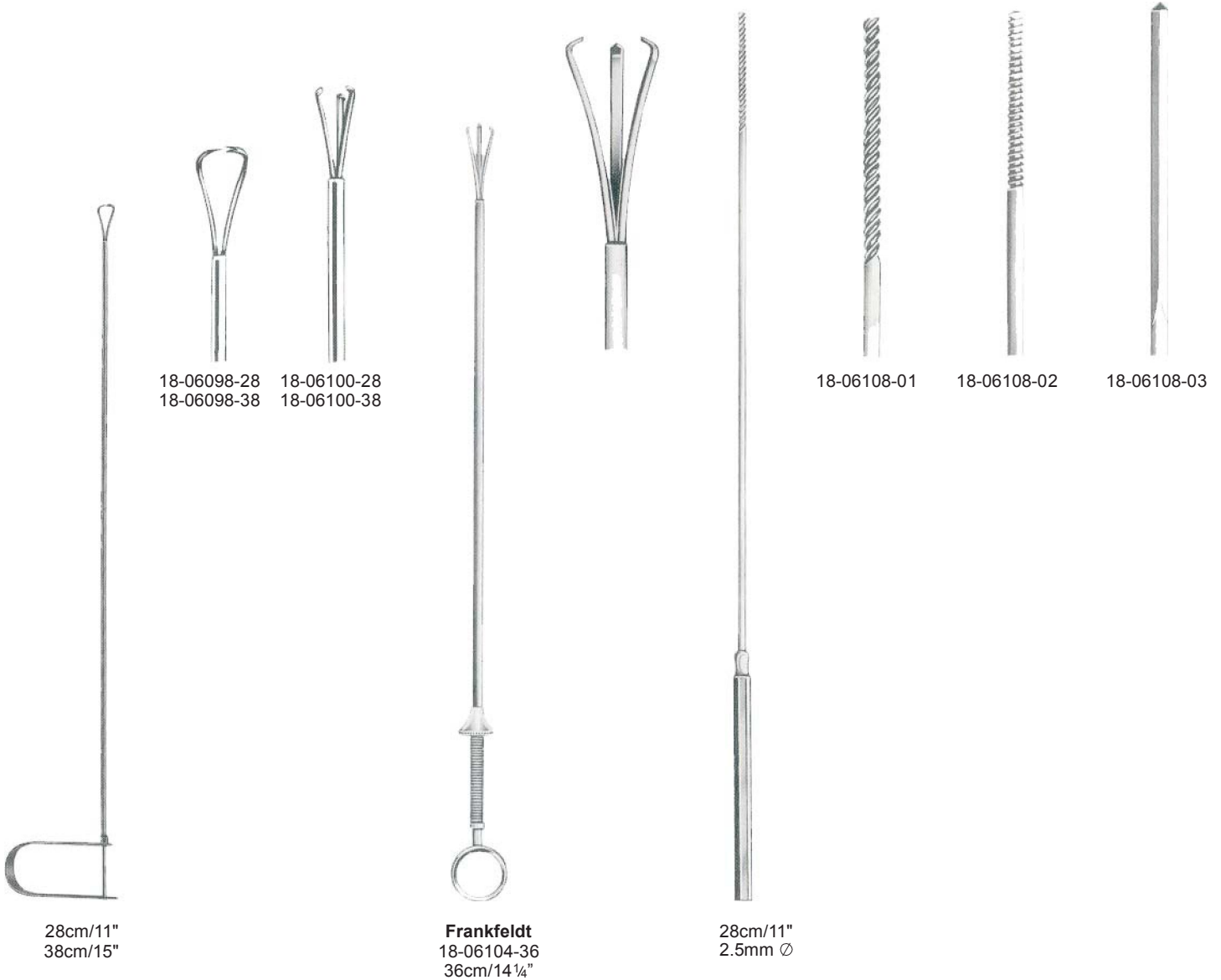





**Nabatoff**  
18-06112-00  
135x100x25mm

Sterilizable

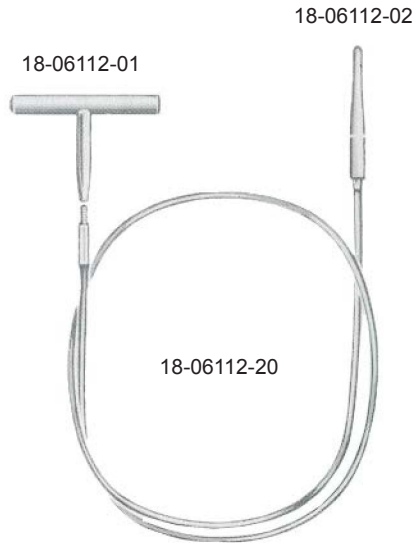

18-06112-01

18-06112-02

18-06112-20



18-06112-03  
3mm Ø

18-06112-06  
6mm Ø

18-06112-09  
9mm Ø

18-06112-12  
12mm Ø

18-06112-15  
15mm Ø

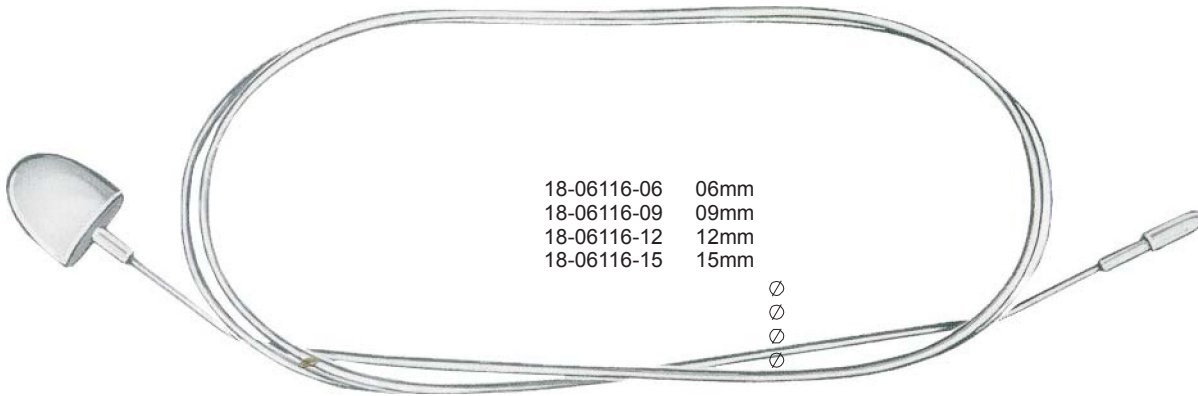

18-06116-06 06mm  
18-06116-09 09mm  
18-06116-12 12mm  
18-06116-15 15mm

Myers

### Strippers



55cm/21½"

	mm Ø
18-06120-02	2.0
18-06120-03	3.0
18-06120-04	4.0
18-06120-06	6.0
18-06120-07	7.0
18-06120-08	8.5
18-06120-10	10.0
18-06120-12	12.0
18-06120-14	14.0



Handlefor  
18-06120-00

### ProbesforVaricoseVeins



Babcock

Malleable

cm	in	
40	13½"	18-06124-40
50	20"	18-06124-50
65	26"	18-06124-65
80	32"	18-06124-80

### VessellrigatingsCannulas



Schmid



18-06128-03  
3mm Ø



18-06128-04  
4mm Ø



18-06128-05  
5mmØ



18-06128-06  
6mmØ

### Spatulas

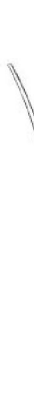

3mm  
Blunt

18-06132-18 18.0cm/7"  
18-06132-21 21.5cm/8 ½"



Schmid



18-06136-14  
14cm/5 ½"  
5mm



18-06136-24  
24cm/9 ¼"

7mm



**Castroviejo**  
14cm/5 1/2"

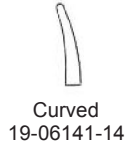

**Castroviejo**

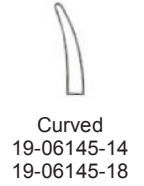

**Castroviejo**  
9cm/3 1/2"

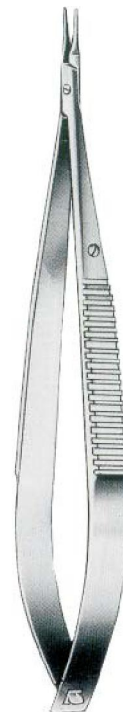

**Castroviejo**  
14cm/5 1/2"





**Castroviejo**  
9cm/3 1/2"



Straight  
19-06156-09



Curved  
19-06157-09



**Paton**  
19-06164-11  
11.5cm/4 1/2"

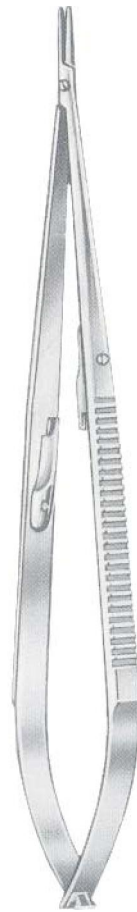

**Jacobson**

cm	in	Without ratchet	With ratchet
18	7"	19-06168-18	19-06170-18
21	8 1/4"	19-06168-21	19-06170-21



Straight  
19-06160-14



Curved  
19-06161-14



**Castroviejo**  
14cm/5 1/2"



Yasargil



Straight

- 19-06174-20 20.0cm/8"
- 19-06174-22 22.5cm/9"



Curved

- 19-06175-16 16.5cm/6 1/2"
- 19-06175-20 20.0cm/9"
- 19-06175-22 22.5cm/9"
- 19-06175-24 24.5cm/9 3/4"



Straight

- 19-06178-16 16.0cm/6 1/4"
- 19-06178-18 18.5cm/7 1/4"



Curved

- 19-06179-16 16.0cm/6 1/4"
- 19-06179-18 18.5cm/7 1/4"





Straight  
19-06182-15  
15cm/6"

Curved  
19-06183-15  
15cm/6"

Straight  
19-06186-18  
18cm/7"

Curved  
19-06187-18  
18cm/7"

Straight  
19-06190-18  
18cm/7"



Straight

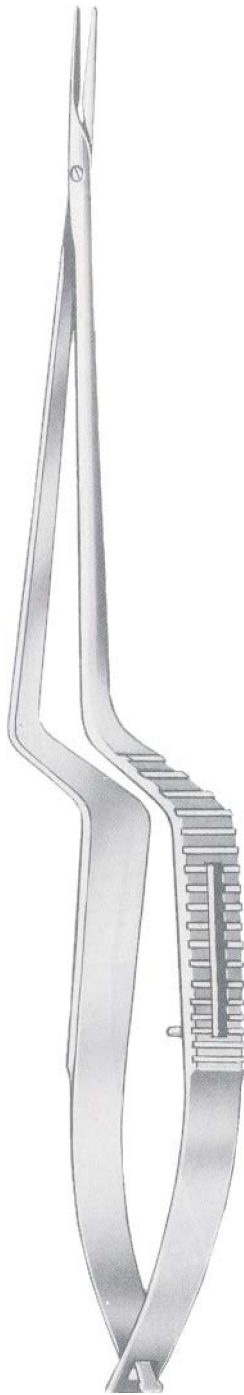

19-06194-18  
19-06194-22

Curved

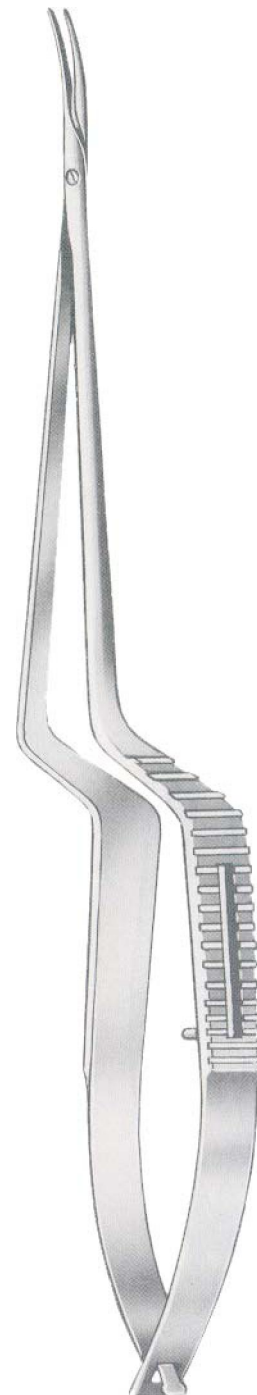

19-06195-18  
19-06195-22

**Yasargil**  
18.0cm/7"  
22.5cm/8 3/4"



Straight  
19-06198-15  
15cm/6"



Curved  
19-06199-15  
15cm/6"



Straight  
19-06206-15  
15cm/6"



Curved  
19-06207-15  
15cm/6"



Straight  
 19-06210-18  
 18.5cm/7 1/4"



Curved  
 19-06211-18  
 18.5cm/7 1/4"



Straight  
 19-06214-18  
 18.5cm/7 1/4"

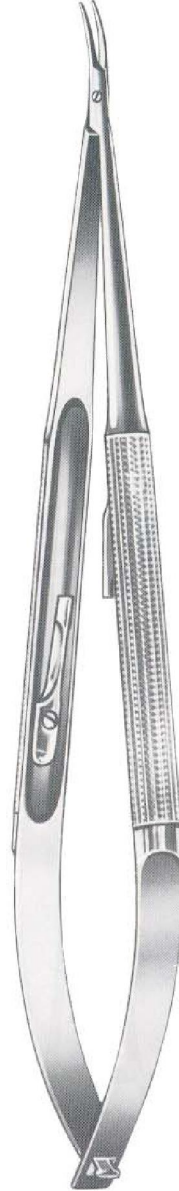

Curved  
 19-06215-18  
 18.5cm/7 1/4"



Straight  
 19-06218-23

Curved  
 19-06219-23

23cm/9"

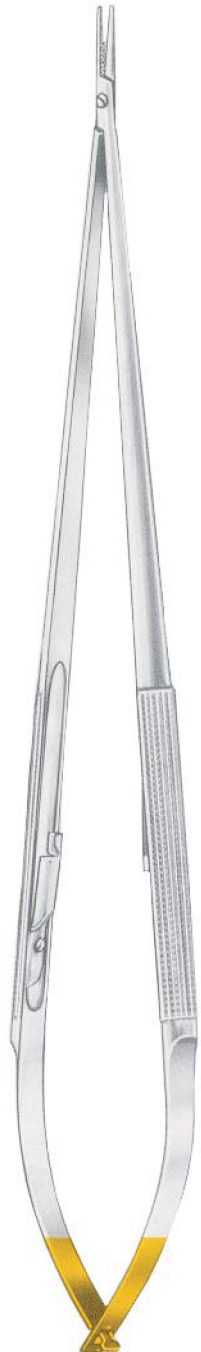

3:1  
**PinsmedTC**



Straight



Curved

19-06222-18 18cm/7"  
 19-06222-21 21cm/8 ¼"  
 19-06222-23 23cm/9 ¼"

Withratchet

19-06223-18 18cm/7"  
 19-06223-21 21cm/8 ¼"  
 19-06223-23 23cm/9 ¼"

Withoutratchet



Straight  
19-06226-12  
12cm/4 3/4"



Curved  
19-06227-12  
12cm/4 3/4"



Angled  
19-06229-12  
12cm/4 3/4"

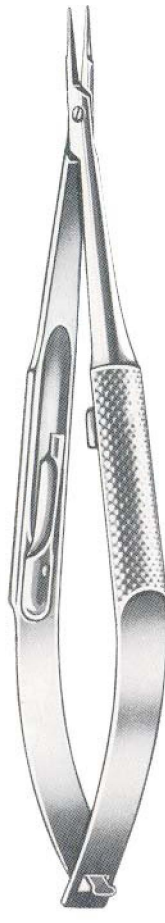

Straight  
19-06232-12  
12cm/4 3/4"



Curved  
19-06233-12  
12cm/4 3/4"



Angled  
19-06235-12  
12cm/4 3/4"





**Arruga**  
 14cm/5"



**Straight**  
 19-06238-14



**Curved**  
 19-06239-14



**Stevens**  
 19-06242-13 13cm/5"  
 19-06242-15 15cm/6"



**Kalt**  
 19-06246-14  
 14cm/5 1/2"



**Castroviejo-Kalt**  
 19-06248-13  
 13.5cm/5 1/4"



**Kalt-Arruga**  
 19-06250-14  
 14cm/5 1/2"





Straight  
19-06254-12



Curved  
19-06255-12



Straight  
19-06258-12



Curved  
19-06259-12

**Castroviejo**  
12cm/4 3/4"

**Castroviejo**  
12cm/4 3/4"



**Castroviejo**  
19-06262-13  
13cm/5"



**Boynton**  
19-06266-12  
12cm/4 3/4"



**Arruga**  
16cm/6 1/4"

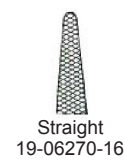

Straight  
19-06270-16



Curved  
19-06271-16



**Castroviejo**

14cm/5 1/2"  
 18cm/7"  
 21cm/8 1/4"

**PinsmedTC**

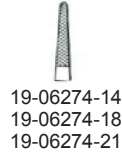

19-06274-14  
 19-06274-18  
 19-06274-21

**Smooth**



19-06278-14  
 19-06278-18  
 19-06278-21



19-06275-14  
 19-06275-18  
 19-06275-21



19-06279-14  
 19-06279-18  
 19-06279-21



**Kalt**  
 14cm/5 1/2"



19-06282-14



19-06284-14



**Barraquer**  
 19-06288-14  
 14cm/5 1/2"



**Castroviejo**  
 19-06292-13  
 13cm/5"



19-06296-18



19-06298-18

Smooth



**Hepp-Schiedel**  
 18cm/7"

## PinsmedTC



**Arruga**  
14cm/5½"

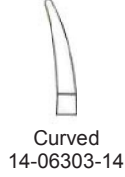

**Jacobson**  
 19-06306-1818cm/7"  
 19-06306-2020cm/8"  
 19-06306-2323cm/8 ¾"



**Diethrich**

Straight		Curved
19-06310-16	16cm/6¼"	19-06311-16
19-06310-18	18cm/7"	19-06311-18
19-06310-20	20cm/8"	19-06311-20
19-06310-23	23cm/9"	19-06311-23
19-06310-25	25cm/10"	19-06311-25



19-06314-13



19-06315-13

Smooth



**Halsey**  
13cm/5"



19-06318-13

Smooth

**Webster**  
13cm/5"



**Derf**  
19-06322-12  
12cm/4¾"



**Derf**  
19-06324-12  
12.5cm/5"



**Collier**  
19-06326-12  
12.5cm/5"



**Hegar-Baumgartner**  
19-06330-14  
14cm/5½"



**Brown**  
19-06334-13 13cm/5"  
19-06334-18 18cm/7"



**New Orleans**  
19-06338-18  
18cm/7"



**Mayo-Hegar**

- |           |             |             |
|-----------|-------------|-------------|
| 13cm/5"   | 19-06342-13 |             |
| 14cm/5½"  | 19-06342-14 |             |
| 16cm/6¼"  | 19-06342-16 | 19-06343-16 |
| 18cm/7"   | 19-06342-18 | 19-06343-18 |
| 20cm/8"   | 19-06342-20 | 19-06343-20 |
| 24cm/9½"  | 19-06342-24 | 19-06343-24 |
| 26cm/10¼" | 19-06342-26 | 19-06343-26 |
| 30cm/12"  | 19-06342-30 | 19-06343-30 |



**Heaney**  
 19-06347-21  
 21cm/8¼"

DelicatePattern



**Mayo-Hegar**  
 19-06350-16 16cm/6 ¼"  
 19-06350-18 18cm/7"  
 19-06350-20 20cm/8"

HeavyPattern



**Hegar**  
 19-6354-16 16cm/6¼"  
 19-6354-18 18cm/7"  
 19-6354-20 20cm/8"





**M.G.H**  
 (Mass.-General-Hospital)  
 19-06358-17  
 17cm/6 ¾"



**Sarot**  
 19-06362-18 18.5cm/7 ¼"  
 19-06362-26 26.0cm/10 ¼"



**Finocchietto**  
 19-06365-27  
 27cm/10 ½"



**Masson**  
 19-06368-27  
 27cm/10 ½"



**Jameson**  
 19-06372-23  
 23.5cm/9 ¼"



**Wangensteen**  
 19-06376-27  
 27cm/10 ½"





**Crile-Wood**  
 19-06380-15  
 15cm/6"



**Crile-Murray**  
 19-06384-15  
 15cm/6"



**Adson**  
 19-06388-18  
 18cm/7"



**Ermold**  
 19-06392-17 17cm/6 ¾"  
 19-06392-20 20cm/8"

Needleholderswithscissors



**Baby-Olsen-Hegar**  
 11.5cm/4 ½"



**Smooth**  
 19-06396-11



**Olsen-Hegar**  
 19-06398-14 14cm/5 ½"  
 19-06398-18 18cm/7"



**Olsen-Hegar**  
 19-06400-17  
 17cm/6 ¾"



**Olsen-Hegar**  
 19-06404-14  
 14cm/5 1/2"



**Gillies**  
 19-06406-16  
 16cm/6 1/4"



**GilliesSlim**  
 19-06408-14  
 14cm/5 1/2"



**Crile**  
 19-06412-15  
 15cm/6"



**Axhausen**  
 19-06416-18  
 18.5cm/7 1/4"



**Lichtenberg**  
 19-06420-20  
 20cm/8"



**Toennis**  
 19-06424-18  
 18cm/7"



**Mathieu**



19-06428-14  
 19-06428-17  
 19-06428-20

14cm/5 1/2"  
 17cm/6 3/4"  
 20cm/8"



19-06430-14  
 19-06430-17  
 19-06430-20



**Mathieu**

19-06434-14 14cm/5 1/2"  
 19-06434-17 17cm/6 3/4"  
 19-06434-20 20cm/8"

Tworingsangled

*PinsmedTC*



**Neivert**  
 19-06438-13  
 13cm/5"



**Neivert**  
 19-06440-13  
 13cm/5"



**Webster**  
 19-06444-13  
 13cm/5"

Smooth



**Derf**  
 19-06448-12  
 12.5cm/5"



**NewOrleans**  
 19-06452-18  
 18cm/7"



**Bozemann**  
 19-06456-20 20cm/8"  
 19-06452-24 24cm/9 1/2"  
 19-06452-26 26cm/10 1/2"



**Mayo-Hegar**

**PinsmedTC**



- 19-06460-16
- 19-06460-18
- 19-06460-20
- 19-06460-24
- 19-06460-26
- 19-06460-30

- 19-06461-20
- 19-06461-24
- 19-06461-26

- 16cm/6¼"
- 18cm/7"
- 20cm/8"
- 24cm/9½"
- 26cm/10½"
- 30cm/12"



**Hegar-Baumgartner**  
 19-06464-14  
 14cm/5½"



**HeavyPattern**

- Mayo-Hegar**  
 19-06470-2020cm/8"  
 19-06470-2424cm/9 ½"



- DeBakey**  
 19-06474-18  
 19-06474-20  
 19-06474-23  
 19-06474-26  
 19-06474-31
- 18cm/7"
  - 20cm/8"
  - 23cm/9"
  - 26cm/10¼"
  - 31cm/12¼"



- DeBakey-Fine**  
 19-06476-18  
 19-06476-20  
 19-06476-23  
 19-06476-26  
 19-06476-31

## PinsmedTC



**Baby-Crile-Wood**  
 19-06480-15  
 15cm/6"



**Crile-Wood**  
 15cm/6"



**Crile-Wood**

	cm	in
19-06492-18	18	7"
19-06492-20	20	8"
19-06492-23	23	9"
19-06492-26	26	10¼"
19-06492-31	31	12¼"

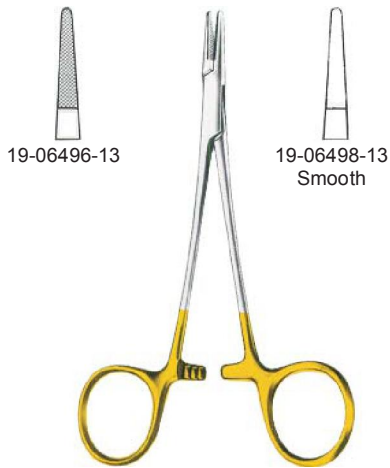

**Halsey**  
 13cm/5"



**Converse**  
 19-06502-12  
 12.5cm/5"



**Kilner**  
 19-06506-13  
 13.5cm/5¼"



## PinsmedTC



**Hegar-Vascular**

- 19-06510-14 14cm/5½"
- 19-06510-18 18cm/7"
- 19-06510-20 20cm/8"
- 19-06510-23 23cm/9"



**Ryder**

- 19-06514-13
- 19-06514-15
- 19-06514-18
- 19-06514-20
- 19-06514-23
- 19-06514-26

**Micro-Ryder**

- 19-06516-13 13cm/5"
- 19-06516-15 15cm/6"
- 19-06516-18 18cm/7"
- 19-06516-20 20cm/8"
- 19-06516-23 23cm/9"
- 19-06516-26 26cm/10¼"



**(Swedish Pattern)**

- 19-06520-1515cm/6"
- 19-06520-1717cm/6¾"
- 19-06520-2020cm/8"



**Sarot**

- 19-06524-1818cm/7"
- 19-06524-26 26cm/10¼"

## PinsmedTC



**Stratte**  
 19-06528-23  
 23cm/9"



**Masson**  
 19-06532-27  
 27cm/10½"



**Wangensteen**  
 19-06534-27  
 27cm/10½"



**Finocchietto**  
 19-06537-20 20cm/8"  
 19-06537-27 27cm/10½"

## PinsmedTC



**Mathieu**

14cm/5½"	19-06540-14
17cm/6¾"	19-06540-17
20cm8"	19-06540-20
24cm/9½"	19-06540-24



**Mathieu**

19-06542-14
19-06542-17
19-06542-20
19-06542-24



**Mathieu-Ryder**

19-06544-17
19-06544-20



**Langenbeck**

16cm/6¼"	19-06548-16
18cm/7"	19-06548-18
20cm/8"	19-06548-20



**Langenbeck-Ryder**

19-06550-18
19-06550-20



**Lichtenberg**

19-06554-20
-------------



**Toennis**  
 19-06558-18  
 18cm/7"

## PinsmedTC



**Mathieu-Kocher**  
 19-06562-1414cm/5 1/2"  
 19-06562-1717cm/6 3/4"  
 19-06562-2020cm/8"



**Axhausen**  
 19-06566-18  
 18.5cm/7 1/4"



**Zweifel**  
 19-06570-2020cm/8"  
 19-06570-2323cm/9"

## PinsmedTC



19-06574-2020cm/8"  
 19-06574-2525cm/10"



**HeavyPattern**  
**Mathieu**  
 19-06578-2020cm/8"  
 19-06578-2424cm/9 1/2"



**Metzenbaum**  
 19-06582-1717cm/6 3/4"  
 19-06582-2020cm/8"



**Arruga**  
 16cm/6 1/4"

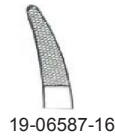
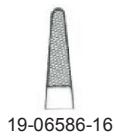

**Boynton**  
 19-06590-12  
 12cm/4 3/4"



**Hosel**  
 19-06594-2020cm/8"  
 19-06594-2525cm/10"

## PinsmedTC



**Baby-Olsen-Hegar**  
 19-06598-11  
 11.5cm/4 1/2"



**Olsen-Hegar**  
 19-06600-14  
 14cm/5 1/2"



**Olsen-Hegar**  
 19-06602-17  
 17cm/6 3/4"



**Olsen-Hegar**  
 19-06604-18  
 18cm/7"



**Gillies-Slim**  
 19-06607-14  
 14.5cm/5 1/2"



**Gillies**  
 19-06609-16  
 16cm/6 1/4"



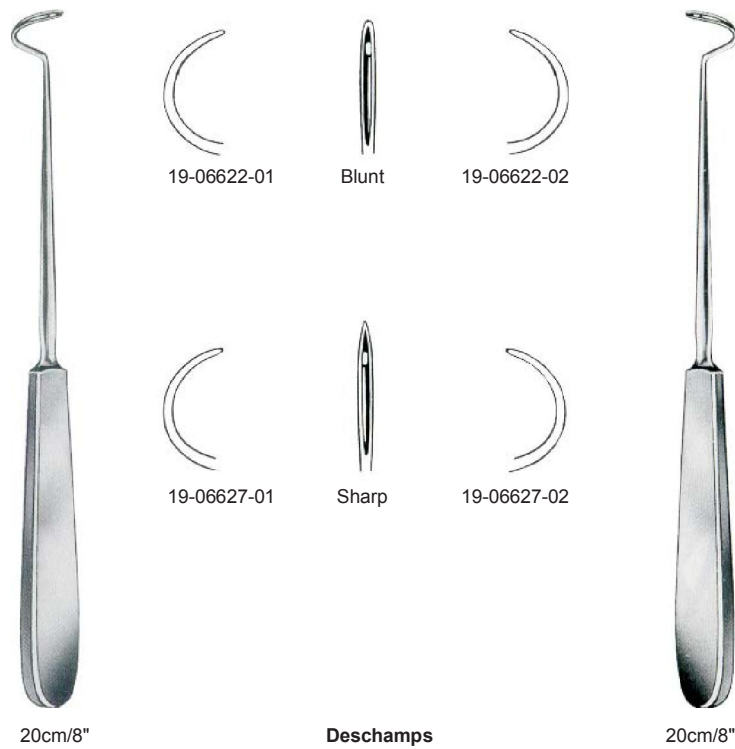
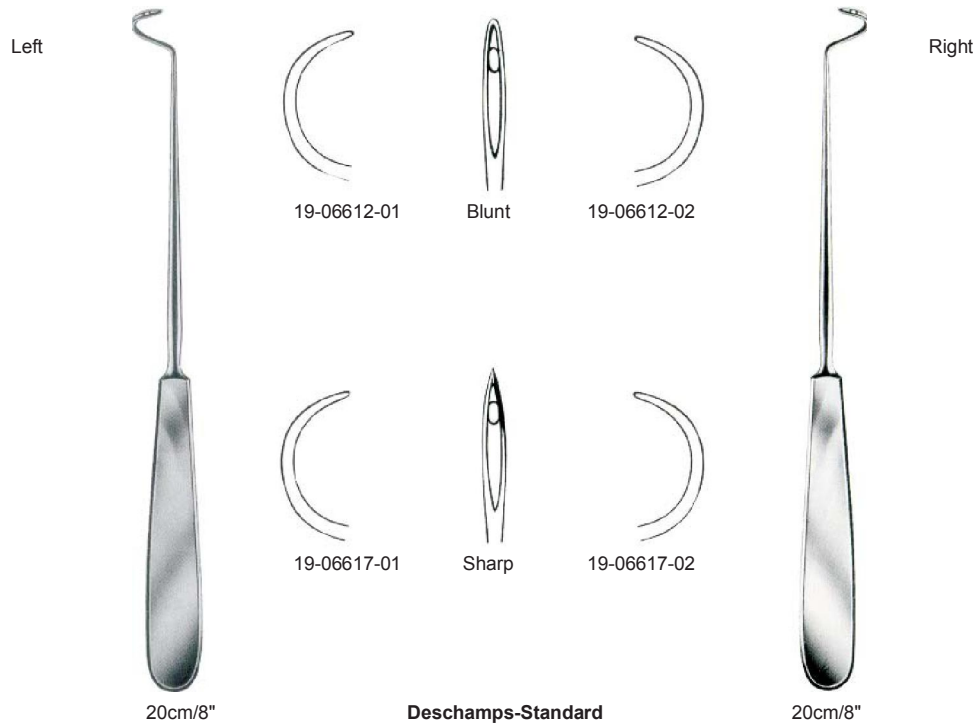

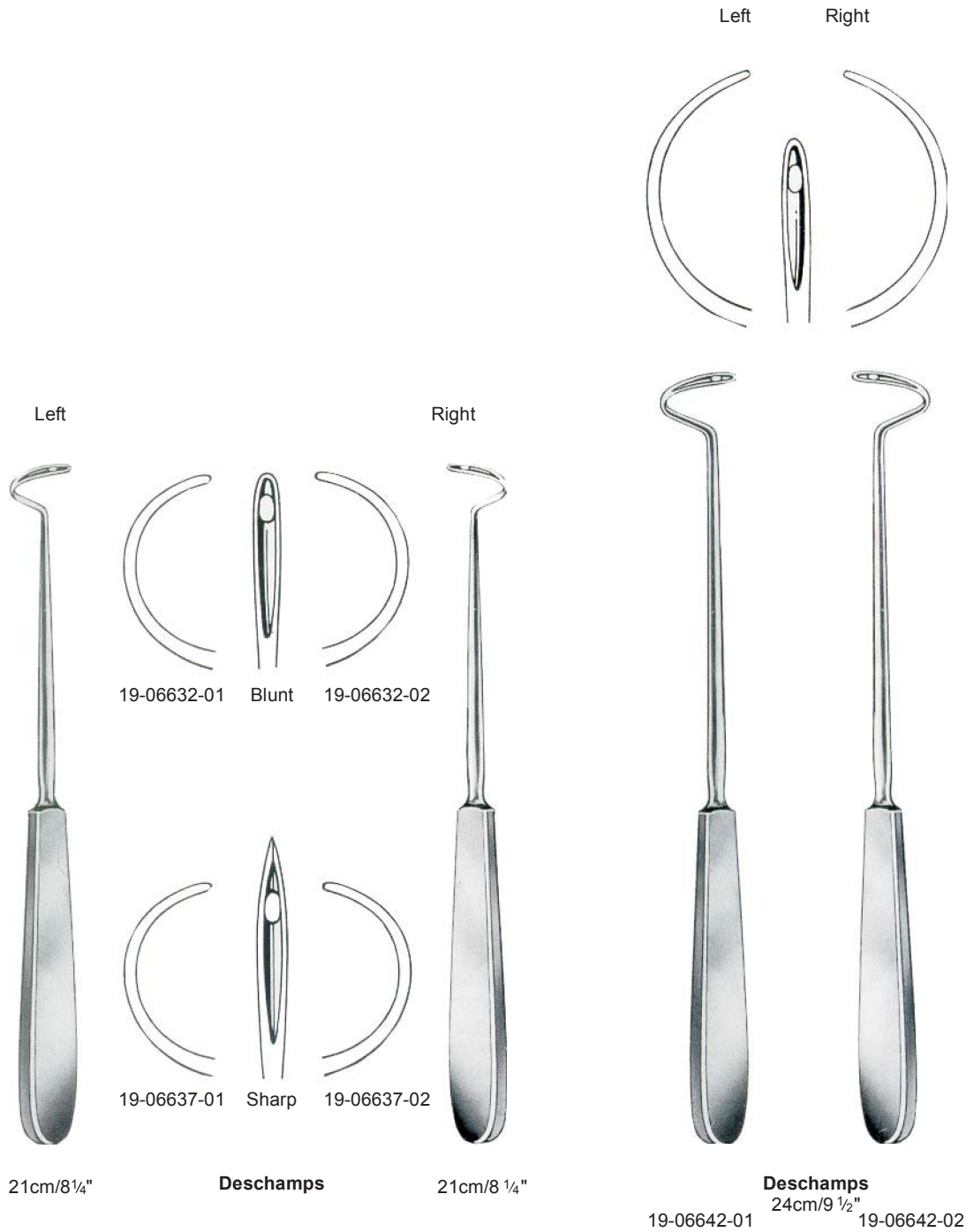

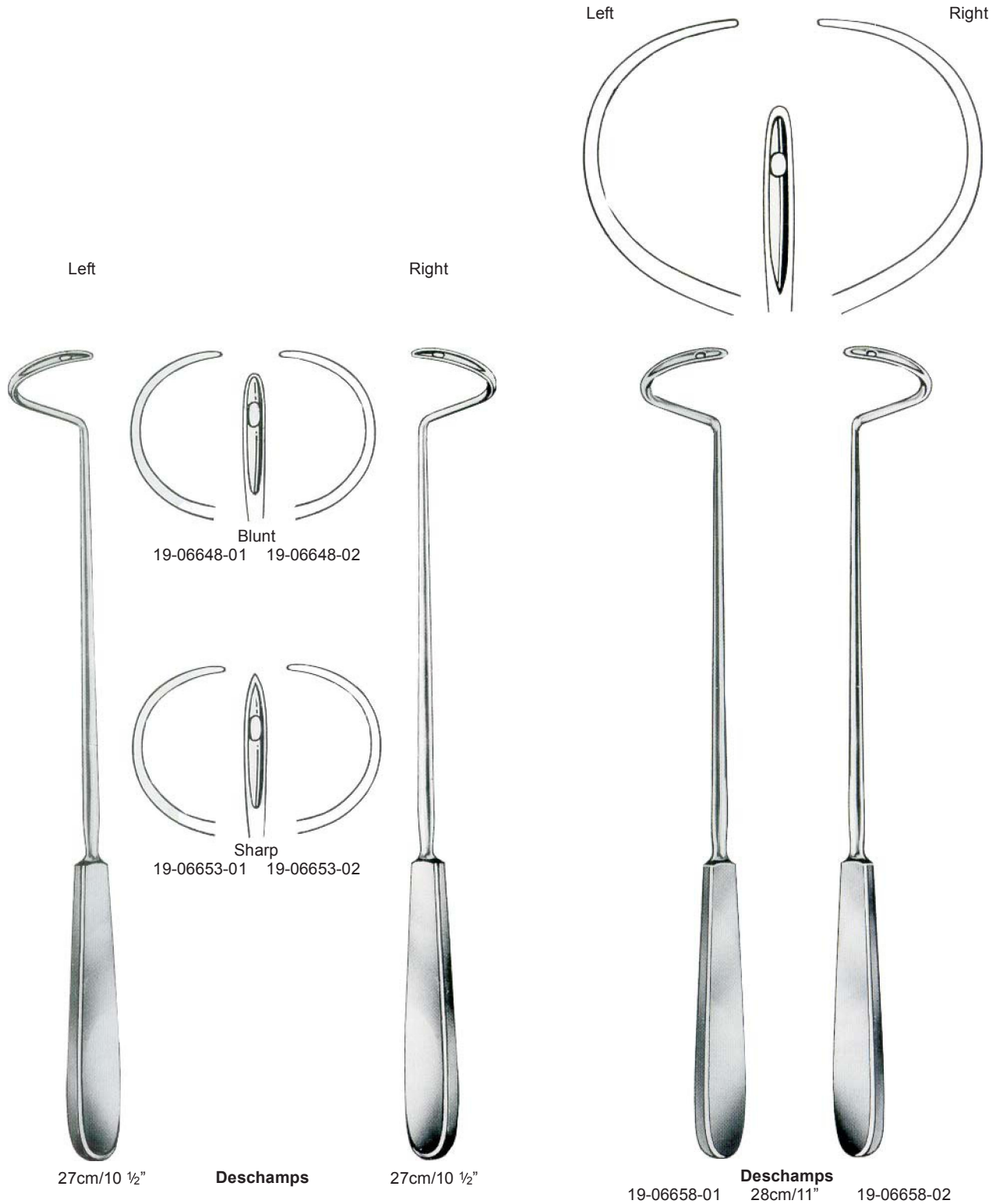

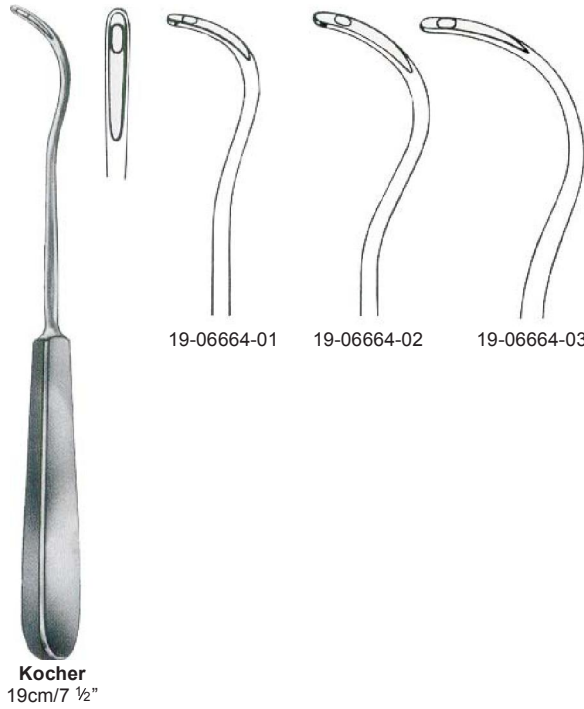



Flexible

**Schmieden-Dick**  
 19-06690-32  
 32cm/12 1/2"



**Schmieden**  
 19-06694-21  
 21cm/8 1/4"



Flexible

19-06698-20  
 20cm/8"



**Cooper**  
 19-06702-19  
 19cm/7 1/2"



With 1 needle

**Young**

19-06705-21 21cm/8 1/4"  
 19-06707-25 25cm/10"



19-06705-01



19-06705-02



19-06705-03

Spare needle only



**Reverdin**  
 14cm/5 1/2"



Fig.1  
 19-06711-01



Fig.2  
 19-06711-02



Fig.3  
 19-06711-03



Fig.4  
 19-06711-04





**Reverdin**  
 19.5cm/7 3/4"



**Fig.1**  
 19-06715-01



**Fig.2**  
 19-06715-02



**Fig.3**  
 19-06715-03



**Fig.4**  
 19-06715-04



**Reverdin**  
 22.5cm/8 3/4"



**Fig.1**  
 19-06717-01



**Fig.2**  
 19-06717-02



**Fig.3**  
 19-06717-03



**Fig.4**  
 19-06717-04



**Brunner**  
19-06720-25  
25cm/10"



**Payr**  
19-06724-22  
22cm/8 3/4"



**Payr**  
19-06726-22  
22cm/8 3/4"



**Brunner**  
19-06730-24  
24.5cm/9 3/4"



**Brunner**  
30cm/12"

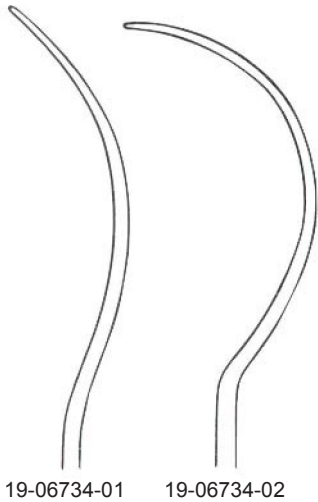

19-06734-01 19-06734-02



19-06734-03



19-06734-04



**Brunner**  
30cm/12"

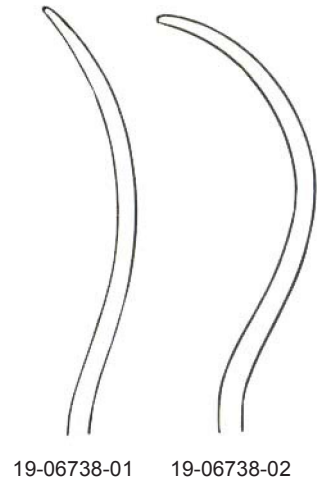

19-06738-01 19-06738-02

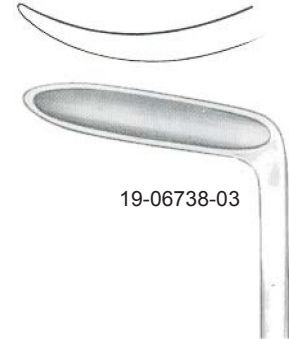

19-06738-03

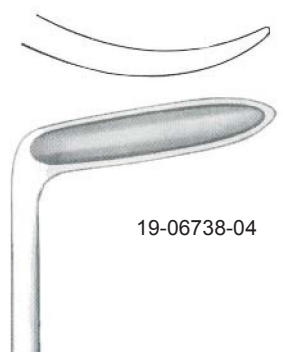

19-06738-04



**Kirschner**  
 19-06742-25  
 25.5cm/10"

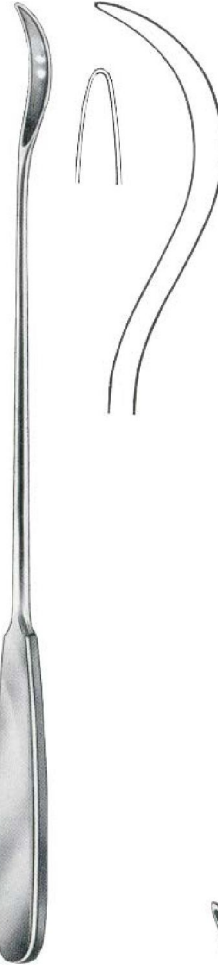

**Brunner-Ferrozell**  
 19-06750-18 18cm/7"  
 19-06750-27 27cm/10 1/2"



**Schmieden-Payr**  
 19-06754-19  
 19cm/7 1/2"

19-06746-28  
 28cm/11"



19cm/7 1/2"  
**Schmieden**  
 19-06756-19



**Konig**  
 19-06760-19  
 19.5cm/7 3/4"



**Konig**  
 19-06762-19  
 19.5cm/7 3/4"



**Konig**  
 19-06764-20  
 20cm/8"



**Wien**  
 19-06768-23  
 23.5cm/9 1/4"



**Bozemann**  
 19-06772-21  
 21cm/8 1/4"



19-06776-23  
 23cm/9"



**Michéal**  
 19-06780-12  
 12cm/4 3/4"



**Michéal**  
 19-06782-12  
 12cm/4 3/4"



**Wachenfeldt**  
 19-06786-12  
 12cm/4 3/4"



**Wachenfeldt**  
 19-06788-12  
 12cm/4 3/4"



**Wachenfeldt**  
 19-06790-13  
 13cm/5"



**Wachenfeldt**  
 19-06792-13  
 13cm/5"



**Michel**  
 19-06796-12  
 12cm/4 3/4"



**MichelModif**  
 19-06798-12  
 12.5cm/5"



**Collin**  
 19-06802-13  
 13cm/5"



**Richter-Heath**  
 19-06806-14  
 14cm/5 1/2"



**Child**  
 19-06810-17  
 17cm/6 3/4"

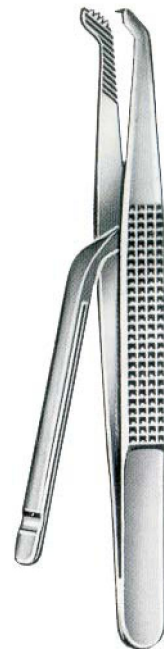

**Child**  
 19-06812-17  
 17cm/6 3/4"





**Hopkins**  
20-06816-20  
20cm/8"



**Esmarch**  
20-06820-18  
18cm/7"



**Reiner**  
20-06824-18  
18.5cm/7 ¼"

PlasterSaw



**Engel**  
20-06828-14  
14cm/5½"



**Henning**  
20-06832-28  
28cm/11"



**Beeson**  
20-06836-30  
30cm/12"



**Haglund-Stille**  
20-06840-28  
28cm/11"



**Mod.USA**  
20-06844-23  
23cm/9"



**Wolff**  
20-06848-1818cm/7"  
20-06848-2424cm/9 1/2"



**Stille**  
20-06852-24  
24cm/9 1/2"



**Stille**  
20-06856-2323cm/9"  
20-06856-2626cm/10 1/4"  
20-06856-3737cm/14 1/2"



**Partsch**  
 mm  
 02 21-06860-02  
 03 21-06860-03  
 04 21-06860-04  
 05 21-06860-05  
 06 21-06860-06  
 07 21-06860-07  
 08 21-06860-08  
 13.5cm/5 1/4"



**Partsch**  
 21-06862-02  
 21-06862-03  
 21-06862-04  
 21-06862-05  
 21-06862-06  
 21-06862-07  
 21-06862-08  
 17cm/6 3/4"  
 21-06866-02  
 21-06866-03  
 21-06866-04  
 21-06866-05  
 21-06866-06  
 21-06866-07  
 21-06866-08  
 13.5cm/5 1/4"  
 21-06868-04  
 21-06868-06  
 21-06868-08  
 21-06868-10  
 21-06868-12  
 21-06868-14  
 21-06868-16  
 17cm/6 3/4"



Width

mm  
 04 21-06870-04 21-06872-04 21-06874-04  
 06 21-06870-06 21-06872-06 21-06874-06  
 08 21-06870-08 21-06872-08 21-06874-08  
 10 21-06870-10 21-06872-10 21-06874-10  
 12 21-06870-12 21-06872-12 21-06874-12  
 14 21-06870-14 21-06872-14 21-06874-14  
 16 21-06870-16 21-06872-16 21-06874-16  
 13.5cm/5 1/4"

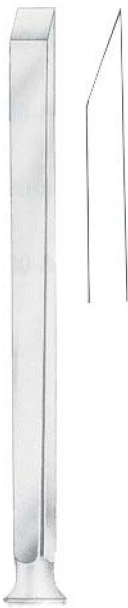

**Mod.USA**  
 mm  
 06 21-06878-06  
 12 21-06878-12  
 18 21-06878-18



21-06880-06  
 21-06880-12  
 21-06880-18  
 16cm/6 1/4"



21-06882-06  
 21-06882-12  
 21-06882-18



16cm/6 1/4"

21-06886-03  
 3mm  
 21-06886-05  
 5mm  
 21-06886-07  
 7mm  
 21-06886-09  
 9mm



21-06890-02  
 2.5mm

21-06890-03  
 3.5mm

**Passow**  
 12cm/4 3/4"



**Lexer**  
27.5cm/10 3/4"

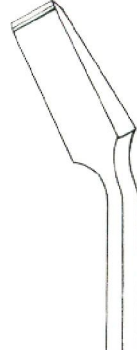
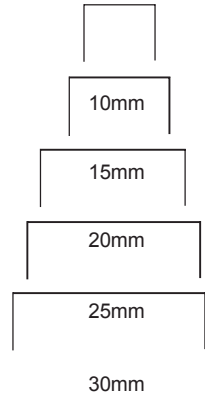

21-06893-10  
21-06893-15  
21-06893-20  
21-06893-25  
21-06893-30

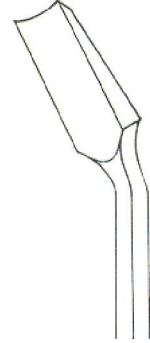

21-06895-10  
21-06895-15  
21-06895-20  
21-06895-25  
21-06895-30



**Cloward**  
24cm/9 1/2"

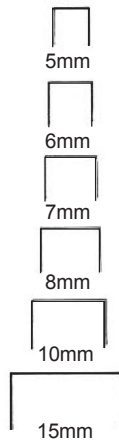

21-06898-05  
21-06898-06  
21-06898-07  
21-06898-08  
21-06898-10  
21-06898-15



21-06900-05  
21-06900-06  
21-06900-07  
21-06900-08  
21-06900-10  
21-06900-15



**Alexander**  
18cm/7"

	mm	
21-06904-04	04	21-06906-04
21-06904-06	06	21-06906-06
21-06904-08	08	21-06906-08
21-06904-10	10	21-06906-10
21-06904-12	12	21-06906-12
21-06904-14	14	21-06906-14



**Hoke**

14cm/5 1/2"

	mm	
21-06910-02	2	21-06911-02
21-06910-03	3	21-06911-03
21-06910-04	4	21-06911-04
21-06910-05	5	21-06911-05
21-06910-06	6	21-06911-06
21-06910-07	7	21-06911-07
21-06910-08	8	21-06911-08

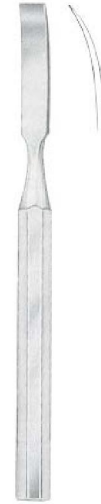

**Smith-Petersen**  
20cm/8"



mm				
06	21-06914-06	21-06915-06	21-06918-06	21-06919-06
09	21-06914-09	21-06915-09	21-06918-09	21-06919-09
13	21-06914-13	21-06915-13		
14			21-06918-14	21-06919-14
16	21-06914-16	21-06915-16	21-06918-16	21-06919-16
19	21-06914-19	21-06915-19	21-06918-19	21-06919-19
25	21-06914-25	21-06915-25	21-06918-25	21-06919-25
32	21-06914-32	21-06915-32	21-06918-32	21-06919-32





**Lambotte**

	mm
21-06922-04	04
21-06922-06	06
21-06922-08	08
21-06922-10	10
21-06922-13	13
21-06922-16	16
21-06922-18	18
21-06922-20	20
21-06922-25	25
21-06922-30	30
21-06922-38	38
21-06922-44	44
21-06922-50	50

24cm/9 1/2"

Curved



21-06923-04	04
21-06923-06	06
21-06923-08	08
21-06923-10	10
21-06923-13	13
21-06923-16	16
21-06923-18	18
21-06923-20	20
21-06923-25	25
21-06923-30	30
21-06923-38	38
21-06923-44	44
21-06923-50	50

23cm/9"



**Mini-Lambotte**

	mm	
21-06926-02	02	21-06927-02
21-06926-03	03	21-06927-03
21-06926-04	04	21-06927-04
21-06926-06	06	21-06927-06
21-06926-08	08	21-06927-08
21-06926-10	10	21-06927-10
21-06926-12	12	21-06927-12
21-06926-15	15	21-06927-15
12.5cm/5"		17cm/6 3/4"



**Mini-Lexer**

	mm	
21-06930-04	04	21-06932-04
21-06930-06	06	21-06932-06
21-06930-08	08	21-06932-08
21-06930-10	10	21-06932-10
21-06930-12	12	21-06932-12

18cm/7"



**Lexer**

	mm	
21-06936-05	05	21-06938-05
21-06936-07	07	21-06938-07
21-06936-10	10	21-06938-10
21-06936-15	15	21-06938-15
21-06936-20	20	21-06938-20
21-06936-25	25	21-06938-25
21-06936-30	30	21-06938-30

22cm/8 3/4"







**Chisel**  
21-06942-20  
24.5cm/9  $\frac{3}{4}$ "  
20mm



**Chisel-Curved**  
21-06943-20  
26.5cm/10  $\frac{1}{2}$ "  
20mm

Gougeforthe  
removingof  
brokenscrews



21-06944-22  
22cm/8  $\frac{3}{4}$ "



Width

mm	21-06950-06	21-06952-06	21-06953-06	21-06956-06	21-06957-06
06	21-06950-06	21-06952-06	21-06953-06	21-06956-06	21-06957-06
08	21-06950-08	21-06952-08	21-06953-08	21-06956-08	21-06957-08
10	21-06950-10	21-06952-10	21-06953-10	21-06956-10	21-06957-10
12	21-06950-12	21-06952-12	21-06953-12	21-06956-12	21-06957-12
15	21-06950-15	21-06952-15	21-06953-15	21-06956-15	21-06957-15
20	21-06950-20	21-06952-20	21-06953-20	21-06956-20	21-06957-20
25	21-06950-25	21-06952-25	21-06953-25	21-06956-25	21-06957-25
30	21-06950-30	21-06952-30	21-06953-30	21-06956-30	21-06957-30

**Hibbs**  
24cm/9 1/2"

mm	21-06960-06	21-06961-06	21-06964-06	21-06966-06	21-06967-06
06	21-06960-06	21-06961-06	21-06964-06	21-06966-06	21-06967-06
09	21-06960-09	21-06961-09	21-06964-09	21-06966-09	21-06967-09
13	21-06960-13	21-06961-13	21-06964-13	21-06966-13	21-06967-13
16	21-06960-16	21-06961-16	21-06964-16	21-06966-16	21-06967-16
19	21-06960-19	21-06961-19	21-06964-19	21-06966-19	21-06967-19
25	21-06960-25	21-06961-25	21-06964-25	21-06966-25	21-06967-25
32	21-06960-32	21-06961-32	21-06964-32	21-06966-32	21-06967-32



mm **Lexer**  
 05 21-06970-05  
 10 21-06970-10  
 15 21-06970-15  
 28cm/11"



**Lexer**  
 21-06972-05  
 21-06972-10  
 21-06972-15  
 25cm/10"



**Lexer**  
 21-06973-05  
 21-06973-10  
 21-06973-15  
 25cm/10"



21-06976-01



21-06977-02



21-06977-03



**Cobb**  
 28cm/11"

21-06977-04



**Volkmann**  
17cm/6 3/4"

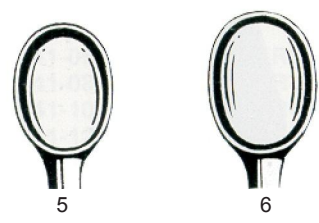

- Fig.  
 0000 21-06980-40  
 000 21-06980-30  
 00 21-06980-20  
 0 21-06980-10  
 1 21-06980-01  
 2 21-06980-02  
 3 21-06980-03  
 4 21-06980-04  
 5 21-06980-05  
 6 21-06980-06



**Volkmann**  
17cm/6 3/4"

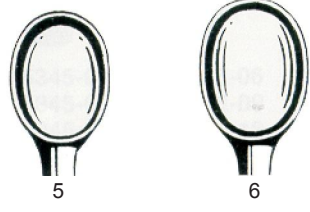
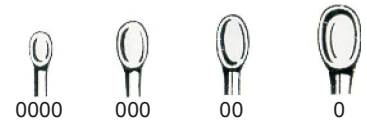

- Fig.  
 0000 21-06984-40  
 000 21-06984-30  
 00 21-06984-20  
 0 21-06984-10  
 1 21-06984-01  
 2 21-06984-02  
 3 21-06984-03  
 4 21-06984-04  
 5 21-06984-05  
 6 21-06984-06

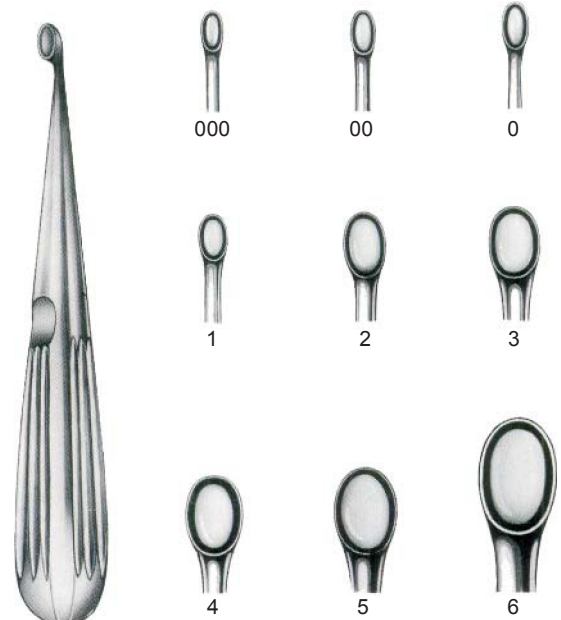

Fig.	A	B	C	D
000	21-06988-30	21-06990-30	21-06991-30	21-06993-30
00	21-06988-20	21-06990-20	21-06991-20	21-06993-20
0	21-06988-10	21-06990-10	21-06991-10	21-06993-10
1	21-06988-01	21-06990-01	21-06991-01	21-06993-01
2	21-06988-02	21-06990-02	21-06991-02	21-06993-02
3	21-06988-03	21-06990-03	21-06991-03	21-06993-03
4	21-06988-04	21-06990-04	21-06991-04	21-06993-04
5	21-06988-05	21-06990-05	21-06991-05	21-06993-05
6	21-06988-06	21-06990-06	21-06991-06	21-06993-06



**Bruns**  
17cm/6 3/4"

Bruns	Fig.	Spratt
21-06996-30	000	21-06998-30
21-06996-20	00	21-06998-20
21-06996-10	0	21-06998-10
21-06996-01	1	21-06998-01
21-06996-02	2	21-06998-02
21-06996-03	3	21-06998-03
21-06996-04	4	21-06998-04
21-06996-05	5	21-06998-05
21-06996-06	6	21-06998-06



**Spratt**  
16cm/6 1/4"



**Swedish pattern**

mm	Round	Oval
2	21-07002-02	21-07004-02
3	21-07002-03	21-07004-03
4	21-07002-04	21-07004-04
5	21-07002-05	21-07004-05
6	21-07002-06	21-07004-06
7	21-07002-07	21-07004-07
8	21-07002-08	21-07004-08
10	21-07002-10	21-07004-10
12	21-07002-12	21-07004-12
14	21-07002-14	21-07004-14
	17cm/6 3/4"	22cm/8 1/2"





**Schede**  
17cm/6 3/4"

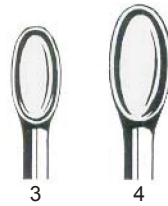
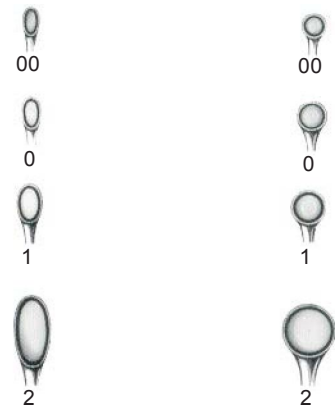

Fig.	
000	21-07008-30
00	21-07008-20
0	21-07008-10
1	21-07008-01
2	21-07008-02
3	21-07008-03
4	21-07008-04



**Williger**  
17.5cm/7"



Straight,Oval

21-07012-20
21-07012-10
21-07012-01
21-07012-02

Straight

Fig.	
00	21-07014-20
0	21-07014-10
1	21-07014-01
2	21-07014-02



21-07017-01

**Uffenorde**  
17cm/6 3/4"



21-07017-02



Fig.0  
21-07018-10



Fig.1  
21-07020-01



Fig.4  
21-07020-04



Fig.0000  
21-07022-40



Fig.00  
21-07024-20



Fig.1  
21-07018-01



Fig.2  
21-07020-02



Fig.5  
21-07020-05



Fig.000  
21-07022-30



Fig.0  
21-07024-10



Fig.2  
21-07018-02



Fig.3  
21-07020-03



Fig.6  
21-07020-06



Fig.00  
21-07022-20



Fig.1  
21-07024-01



Fig.3  
21-07018-03



Simon  
24cm/9 1/2"



Fig.0  
21-07022-10



Fig.2  
21-07024-02



Volkman  
27cm/10 1/2"



Simon  
24cm/9 1/2"



Daubenspeck  
20cm/8"

Flexible





	Volkman		Volkman
Length	Oval/Oval		Oval/Round
cm	in		
13	5"	21-07038-13	21-07040-13
14	5½"	21-07038-14	
16	6¼"		21-07040-16
17	6¾"	21-07038-17	
20	8"	21-07038-20	21-07040-20



**Martini**  
13.5cm/5"



**Jansen**  
21-07046-15  
15cm/6"



**Jansen**  
21-07050-16  
16cm/6 ¼"



**Williger**  
13.5cm/5"



**Jacobson**  
21-07058-13  
13cm/5"



**Janson**  
21-07062-15  
15cm/6"



**Barth**  
21-07064-18  
18cm/7"



21-07066-21  
21cm/8 1/4"



**Epstein**



**Spinal**



**Spinal**

Fig.  
000  
00  
0  
1  
2  
3  
4  
5  
6

21-07069-30	21-07072-30	21-07074-30
21-07069-20	21-07072-20	21-07074-20
21-07069-10	21-07072-10	21-07074-10
21-07069-01	21-07072-01	21-07074-01
21-07069-02	21-07072-02	21-07074-02
21-07069-03	21-07072-03	21-07074-03
21-07069-04	21-07072-04	21-07074-04
21-07069-05	21-07072-05	21-07074-05
21-07069-06	21-07072-06	21-07074-06
20cm/8"	20cm/8"	20cm/8"



**Putti**  
21-07078-30  
30cm/12"



**Putti**  
21-07080-27  
27cm/10 1/2"



21-07084-25  
25cm/10"



21-07088-24  
24cm/9 1/2"



21-07092-22  
22cm/8 3/4"





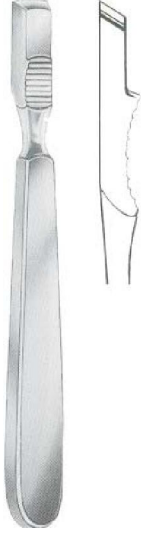

**Farabeuf**  
21-07096-15  
15cm/6"



**Farabeuf**  
21-07098-15  
15cm/6"



**Farabeuf-Collin**  
21-07100-15  
15.5cm/6"  
11mm



**Farabeuf-Collin**  
21-07102-15  
15.5cm/6"  
11mm



**Farabeuf**  
21-07104-19  
19cm/7 1/2"  
13mm



**Sedillot**  
21-07108-18  
18cm/7"  
18mm



**Sedillot**  
21-07110-21  
21cm/8 1/4"  
15mm



**Langenbeck**  
21-07114-19  
19cm/7 1/2"



**Langenbeck**  
21-07116-18  
18cm/7"



**Lambotte**  
21cm/8 1/4"

Width

	mm
21-07120-05	05
21-07120-10	10
21-07120-15	15
21-07120-20	20
21-07120-25	25



**Schneider**  
21-07124-17  
13mm  
17.5cm/7"



**Schneider-Sauerbruch**  
21-07126-19  
13mm  
19cm/7 1/2"



**Alexander**  
21-07130-20  
20cm/8"



**Jansen**  
21-07134-16  
15mm  
16.5cm/6 1/2"



**Seldin**  
21-07138-19  
19cm/7 1/2"



**Davidson-Alexander**  
21-07142-29  
29cm/11 1/2"

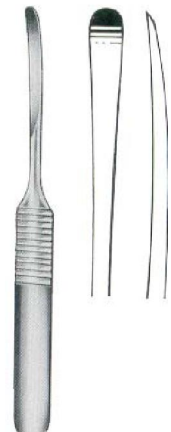

**Williger**  
21-07146-29  
13cm/5"

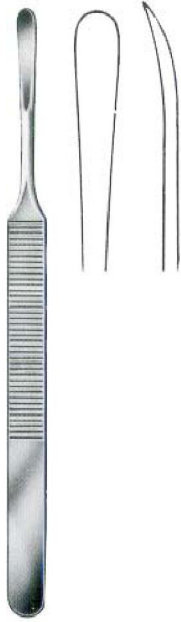

**König**  
21-07150-15  
15.5cm/6"  
5mm



**Williger**  
21-07154-16  
16cm/6 ¼"



**Adson**  
17cm/6 ¾"



21-07158-01



21-07158-02



21-07158-03



21-07158-04

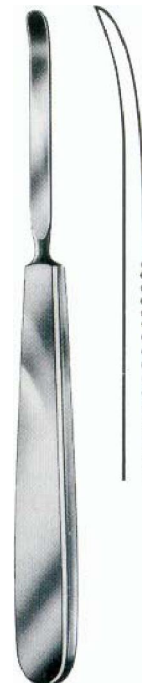

21-07162-06 17cm/6 ¾"  
6mm



21-07162-08  
8mm



**Overholt**  
21-07166-29  
29.5cm/11 1/2"



**Overholt**  
21-07168-29  
29.5cm/11 1/2"



**Overholt**  
21-07170-28  
28.5cm/11 1/4"



**Hyllin**  
21-07174-03  
14.5cm/5 3/4"



21-07174-01



21-07174-02



21-07174-03



**Matson**  
21-07178-22  
22cm/8 3/4"



**Semb**

21-07182-01  
19.5cm/7 1/2"  
12mm

21-07182-02  
19.5cm/7 1/2"  
12mm

21-07182-03  
19.5cm/7 1/2"  
12mm

21-07182-04  
22cm/8 3/4"  
13mm

21-07182-05  
21.5cm/8 1/2"  
13mm

21-07182-06  
22cm/8 1/2"  
15mm

21-07182-07  
22cm/8 1/2"  
15mm



**Doyen**  
17cm/6 3/4"

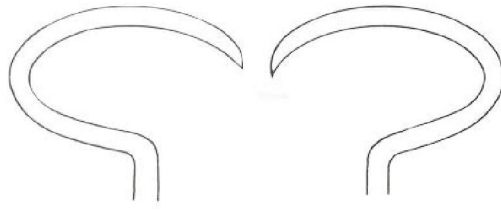

21-07186-01

21-07186-02

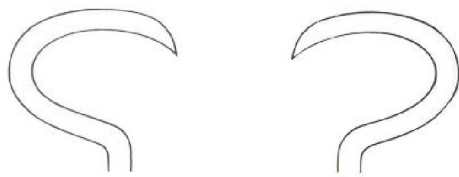

21-07188-01

21-07188-02



**Doyen**  
24cm/9 1/2"



**Doyen**  
24cm/9 1/2" 21-07190-02



21-07194-04  
4mm



21-07194-06  
6mm



21-07194-08  
8mm



**Cobb**  
24cm/9 1/2"



21-07194-10  
10mm



21-07194-13  
13mm



21-07194-19  
19mm



21-07194-25  
25mm





21-07198-01  
19cm/7 1/2"  
6mm



21-07199-02  
18.5cm/7 1/4"  
3mm



21-07201-03  
18.5cm/7 1/4"  
6mm



21-07203-04  
18.5cm/7 1/4"  
6mm

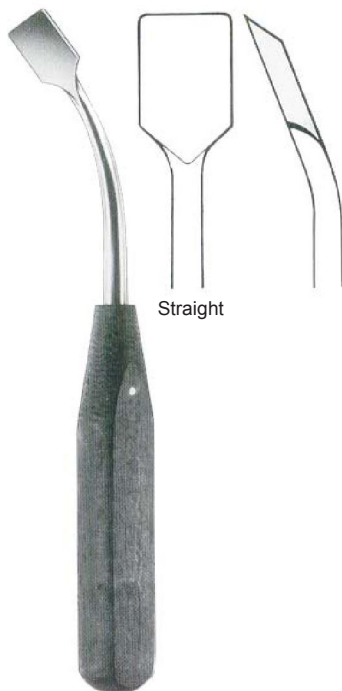

21-07206-05  
18.5cm/7 1/4"  
13mm



21-07207-06  
19.5cm/7 3/4"  
14mm



21-07209-07  
18.5cm/7 1/4"  
14mm



21-07211-08  
20cm/8"  
20mm



21-07214-20  
27.5cm/10 3/4"  
20mm

**Wagner**  
8mm 21-07218-08 33cm/13"  
17mm 21-07218-17 33cm/13"

**Cobb**  
10mm 21-07222-10 25cm/10"  
13mm 21-07222-13 25cm/10"  
19mm 21-07222-19 25cm/10"  
25mm 21-07222-25 25cm/10"

**Cobb**  
10mm 21-07224-10 28cm/11"  
13mm 21-07224-13 28cm/11"  
19mm 21-07224-19 28cm/11"



**Hoerl**

21-07228-07  
16cm/6 ¼"  
7mm

21-07228-15  
18.5cm/7 ¼"  
15mm

21-07228-20  
19cm/7 ½"  
20mm



**Yankauer**  
21-07232-18  
18cm/7"



**Langenbeck**  
21-07236-20  
20cm/8"  
8mm



**Langenbeck**  
21-07238-20  
20cm/8"  
10mm



**Langenbeck**  
21-07240-23  
23cm/9"  
11mm



**Mass.Gen.Hosp.**  
21-07244-15  
15cm/6"



**Williger**  
21-07248-17  
17cm/6 ¾"  
5.5mm



**Williger**  
21-07250-16  
16cm/6 ¼"

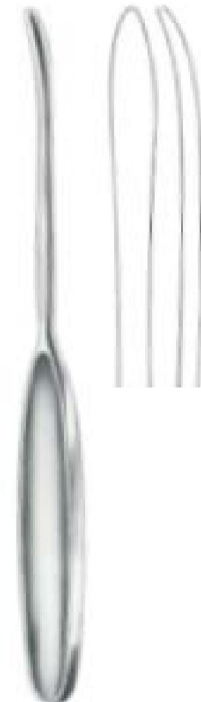

**Quervain**  
21-07254-20  
20cm/8"





21-07288-14  
14cm/5 1/2"  
2.8mm



21-07288-15  
15cm/6"  
5mm



21-07290-15  
15cm/6"  
7mm

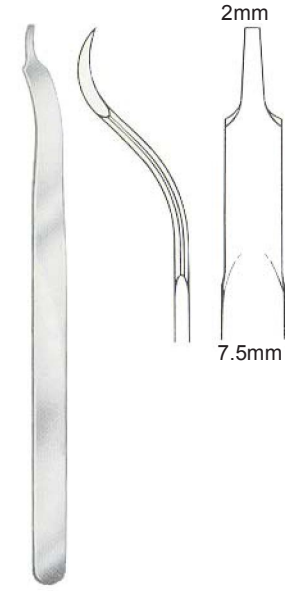

**Buck-Gramcko**  
21-07292-15  
15cm/6"

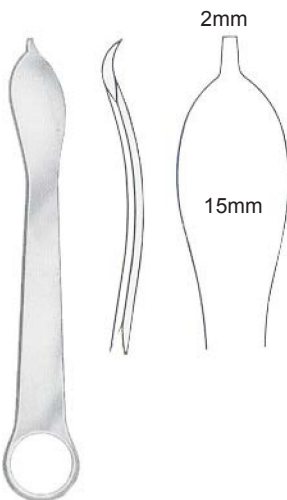

21-07296-12  
12.5cm/5"

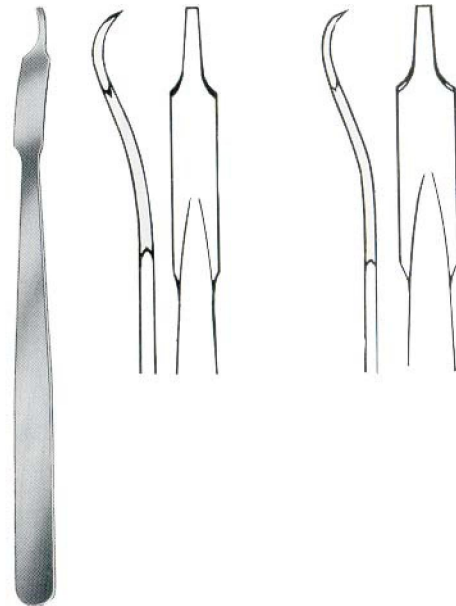

**Mini-Hohmann** 21-07300-06  
16cm/6 1/4" 6mm

21-07302-08  
8mm

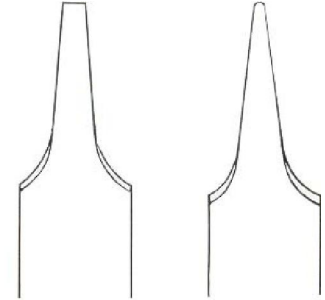

21-07306-17  
17mm

21-07308-17  
17mm



21-07304-26  
26.5cm/10 1/2"  
24mm



**Lange-Hohmann**  
21-07305-26  
26cm/10 1/4"  
22mm



**Hohmann**  
21-07308-22  
22cm/8 3/4"  
8mm



**Hohmann**  
21-07308-24  
24cm/9 1/2"  
14mm





**Hohmann**  
21-07308-26  
26cm/10 1/4"  
22mm

**Hohmann**  
21-07308-28  
28cm/11"  
33mm

**Hohmann**  
21-07310-24  
24cm/9 1/2"  
43mm

**Hohmann**  
21-07312-24  
24.5cm/9 3/4"  
43mm

**Hohmann**  
21-07314-24  
24cm/9 1/2"  
70mm

**Hohmann**  
21-07316-22  
22cm/8 3/4"  
18mm



	<b>Lange-Hohmannmodif</b>		<b>Hohmann-Aldinger</b>	
30mm	21-07316-26	26.5cm/10 1/2"	21-07318-27	
33mm	21-07316-29	29.0cm/11 1/2"	27cm/10 1/2"	

**Schumacher**  
(Wagner)  
21-07318-34  
34.5cm/13 1/2"

**Schumacher**  
21-07320-29  
29cm/11 1/2"

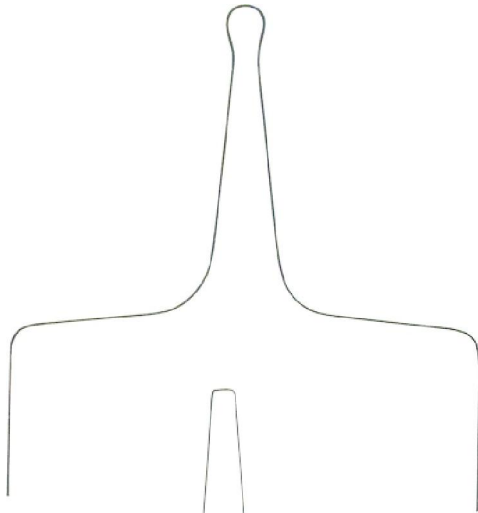

21-07322-25  
25.5cm/10"  
65mm

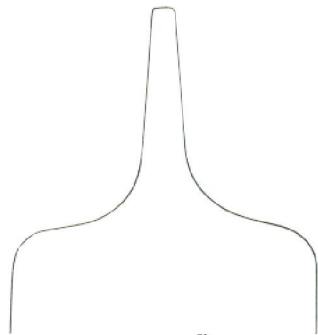

21-07322-24  
24cm/9"  
42mm



**Verbrugge-Muller**



**Lane-Trethowan**  
21-07324-21  
21.5cm/8 1/2"



**Lane**  
21-07328-25  
25.5cm/10"



**Bristow**  
21-07332-23  
23cm/9"



**Murphy-Lane**  
21-07336-32  
32cm/12 ½"



**Chandler**

Length	Width	
18cm	13mm	21-07340-13
20cm	19mm	21-07340-19
23cm	25mm	21-07340-23
25cm	30mm	21-07340-30



**Blount**  
21-07344-26  
26cm/10 ¼"



**Blount**  
21-07346-26  
26cm/10 ¼"



**Bennett** 21-07350-44 44mm  
21-07350-64 64mm



**Smillie**  
14cm/5 1/2"

21-07354-01  
32x19mm

21-07354-02  
48x19mm

21-07354-03  
57x19mm



21-07356-04  
52x13mm



21-07358-05  
12x13mm

Spinal retractors



21-07362-01  
75x30mm

21-07362-02  
100x30mm

**Taylor**  
17cm/6 1/2"



21-07366-21  
21.5cm/8 1/2"

Meniscus retractors



**Blount**  
21-07370-17  
17.5cm/7"

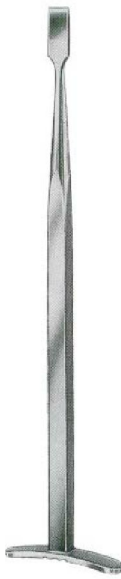

**Smillie**  
21-07374-17  
17cm/6 3/4"



**Smillie**  
21-07376-17  
17cm/6 3/4"



**Smillie**  
21-07378-17  
17cm/6 3/4"



**Salenius**  
21-07382-22  
22cm/8 3/4"



**Salenius**  
21-07384-22  
22cm/8 3/4"



21-07388-17  
17.5cm/7"



**Neff**  
21-07392-21  
21.5cm/8 1/2"



**Canad-Modell**  
21-07396-01 20cm/8"



21-07396-02



**Bircher**  
21-07402-20  
20.5cm/8"



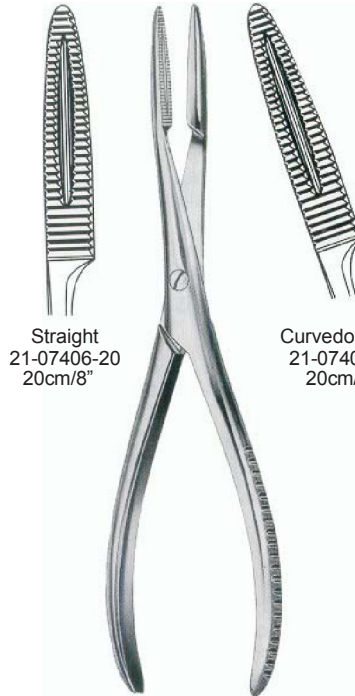

**Straight**  
21-07406-20  
20cm/8"

**Curved on Flat**  
21-07407-20  
20cm/8"



**VanBuren**  
21-07410-23  
23cm/9"



**Dingmann**  
21-07414-19  
19cm/7 1/2"



**Dingmann Modif**  
21-07416-19  
19cm/7 1/2"



**Neff**  
21-07420-21  
21cm/8 1/4"

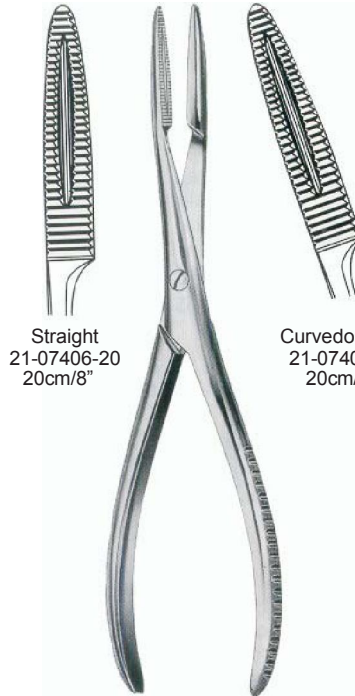

**Straight**  
21-07406-20  
20cm/8"

**Curved on Flat**  
21-07407-20  
20cm/8"



**VanBuren**  
21-07410-23  
23cm/9"



**Dingmann**  
21-07414-19  
19cm/7 1/2"



**Dingmann Modif**  
21-07416-19  
19cm/7 1/2"



**Neff**  
21-07420-21  
21cm/8 1/4"



21-07450-16  
16cm/6 1/4"  
21-07450-24  
24cm/9 1/2"



Without Ratchet	Kern		With Ratchet
	cm	in	
21-07454-17	17	6 3/4"	21-07456-17
21-07454-21	21	8 1/4"	21-07456-21



21-07460-18	18cm/07"	21-07461-18
21-07460-23	23cm/09"	21-07461-23
21-07460-25	25cm/10"	21-07461-25
21-07460-28	28cm/11"	21-07461-28



**Hey Groves**  
21-07464-21 21.0cm/8 1/4"  
21-07464-27 27.0cm/10 1/2"  
21-07464-30 30.5cm/12"



**Semb**  
21-07468-19  
19cm/7 1/2"



**Semb**  
21-07470-19  
19cm/7 1/2"



**Verbrugge**  
21-07474-17  
17.5cm/7"



21-07478-25  
25cm/10"

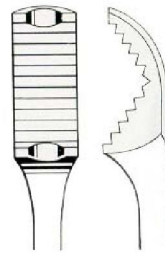
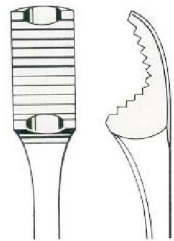

21-07478-26  
26cm/10 1/4"  
**Verbrugge**

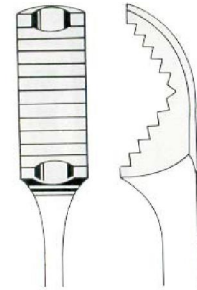

21-07478-27  
27cm/10 1/2"



21-07482-1515cm/6"  
 21-07482-1919cm/7 1/2"  
 21-07482-2424cm/9 1/2"  
 21-07482-2626cm/10 1/4"  
 21-07482-2828cm/11"



Handles Detachable

**Percy**  
 21-07486-30

Adjustable



**Lambotte**  
 21-07490-2222cm/8 3/4"  
 21-07490-2727cm/10 1/2"  
 21-07490-3030cm/12"



**Farabeuf**  
 21-07494-2323cm/9"  
 21-07494-2626cm/10 1/4"



**Lambotte**  
 21-07498-2222.5cm/9"  
 21-07498-2525.5cm/10 1/2"  
 21-07498-3333cm/13 1/2"





**Farabeuf-Lambotte**  
21-07502-26  
26cm/10 ¼"



**Lambotte**  
21-07506-1919cm/7 ½"  
21-07506-2323cm/9"  
21-07506-2626cm/10 ¼"



Without Ratchet	Lane	With Ratchet
	cm in	
21-07510-33	33 13"	21-07514-33
21-07510-45	45 17¾"	21-07514-45



21-07518-14  
14.5cm/5 ¾"



21-07522-12  
12cm/4 ¾"







**Stellbrink**  
17.5cm/7"



**Bane-Hartmann**  
21-07563-17  
17.5cm/7"



**Mini-Friedmann**  
21-07567-12  
12.5cm/5"



**Friedmann**  
21-07571-14  
14cm/5 1/2"



**Friedmann-Delicate**  
15cm/6"



21-07575-15



90°

21-07577-15

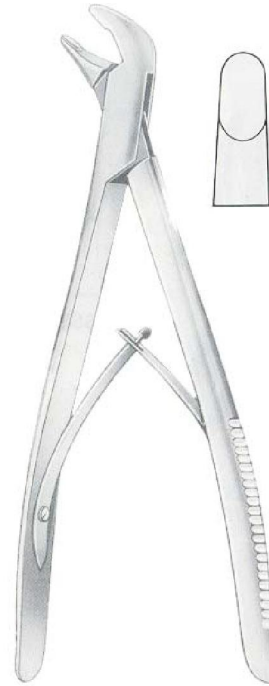

**Bacon**  
21-07580-20  
20cm/8"



**Cleveland**  
21-07583-14 14cm/5 1/2"  
21-07583-17 17cm/6 3/4"



**Hartmann**  
21-07587-18  
18.5cm/7 1/4"



**Olivecrona**  
21-07591-20  
20cm/8"



21-07595-16



21-07597-16

**Mead**  
16.5cm/6 1/2"



**Lempert**

	cm	in	
Straight	16	6 1/4"	21-07603-16
Curved	19	7 1/2"	21-07603-19



**Beyer**  
21-07607-18  
18cm/7"



21-07610-17



21-07611-17

**Jansen**  
17.5cm/7"



**Blumenthal**  
15.5cm/6"



21-07615-15



21-07617-15



21-07619-15



**Hakansson**  
21-07621-15  
15.5cm/6"



**Jansen**  
21-07623-18  
18cm/7"

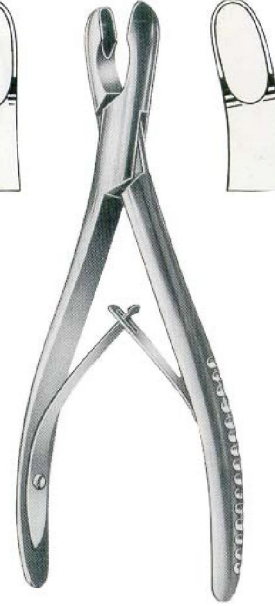

Straight  
21-07626-17

Curved  
21-07627-17

**Luer**  
17cm/6 3/4"



HeavyPattern

**Luer**  
18.5cm/7 1/4"

Straight  
21-07630-18

Curved  
21-07631-18



**Luer**  
15cm/6"



21-07635-15



21-07637-15



21-07639-15



**Adson**  
20cm/8"



21-07642-20





**Kleinert-Kutz**  
15cm/6"



21-07645-15  
2mm



21-07647-15  
3mm



**Bohler**  
15cm/6"



21-07650-15



21-07651-15



**Beyer  
Zaufal-Jansen**  
18cm/7"



**Zaufal-Jansen**  
21-07653-18



**Beyer**  
21-07655-18



**Mayfield**  
21-07659-17  
17cm/6 3/4"



**Ruskin**  
21-07663-18  
18cm/7"  
Angled



**Straight**  
21-07666-18  
18cm/7"  
21-07666-23  
23cm/9"



**Ruskin**

**Curved**  
21-07667-18  
18cm/7"  
21-07667-23  
23cm/9"





**Marquardt**  
21-07671-20  
20cm/8"



**Rottgen-Ruskin**  
21-07675-24  
24cm/9 1/2"



21-7679-03  
3mm



21-7679-04  
4mm



21-7679-05  
5mm



21-7681-03  
3mm



21-7681-04  
4mm



21-7681-05  
5 mm



**Smith-Petersen**  
24cm/9 1/2"



**Stille-Luer**  
22cm/8 3/4"



**Straight**  
21-07684-22



**Curved**  
21-07685-22



**Stille-Luer**  
27cm/10 1/2"



21-07688-27



21-07689-27



**Semb**  
21-07693-23  
23cm/9"



**Stille-Ruskin**  
21-07697-23  
23cm/9"



**Echlin**  
23cm/9"



**Leksell**  
23cm/9"

21-07701-02  
2mm

21-07701-03  
3mm

21-07701-04  
4mm

21-07705-03  
3mm

21-07705-04  
4mm

21-07705-06  
6mm

21-07705-08  
8mm



**Frykholm**  
21-07709-23  
23cm/9"



**Stille**  
21-07713-23  
23cm/9"



**Sauerbruch**  
30cm/12"

21-07716-30

21-07718-30



**Markwalder**  
21-07721-20  
20cm/8"



**Straight Liston**  
cm in  
21-07724-14 14 5½  
21-07724-17 17 6¾  
21-07724-19 19 7½  
21-07724-22 22 8¾



**Curved Liston**  
21-07725-14  
21-07725-17  
21-07725-19  
21-07725-22



**Littauer-Liston**  
21-07728-15  
15cm/6"



**Cleveland**  
21-07731-15 15cm/6"  
21-07731-17 17cm/6 ¾"



**Bohler**  
15cm/6"



**Straight Liston**  
21-07734-15



**Curved Liston**  
21-07735-15



**McIndoe**  
21-07739-17  
17.5cm/7"





**Kazanjan**  
21-07742-18  
18cm/7"



**Ruskin-Liston**  
18.5cm/7 ¼"

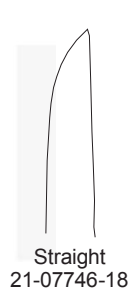

**Straight**  
21-07746-18

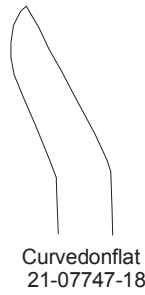

**Curved on flat**  
21-07747-18



**Stille-Liston**  
23cm/9"  
27cm/10 ½"

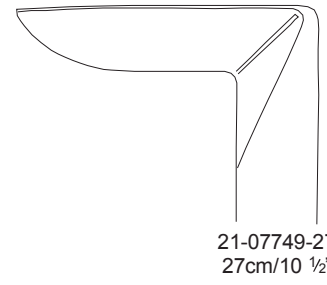

21-07749-27  
27cm/10 ½"

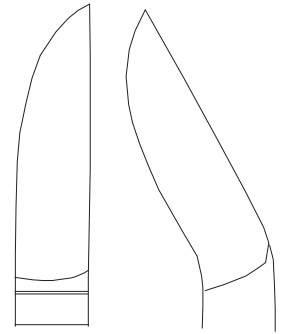

21-07750-23  
21-07750-27

21-07751-23  
21-07751-27

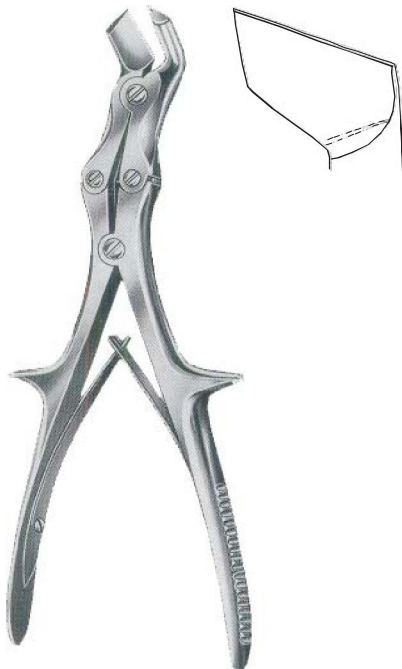

**Liston-Key (Horsley)**  
21-07753-27  
27cm/10 ½"



**Semb**  
21-07755-24  
24cm/9 ½"

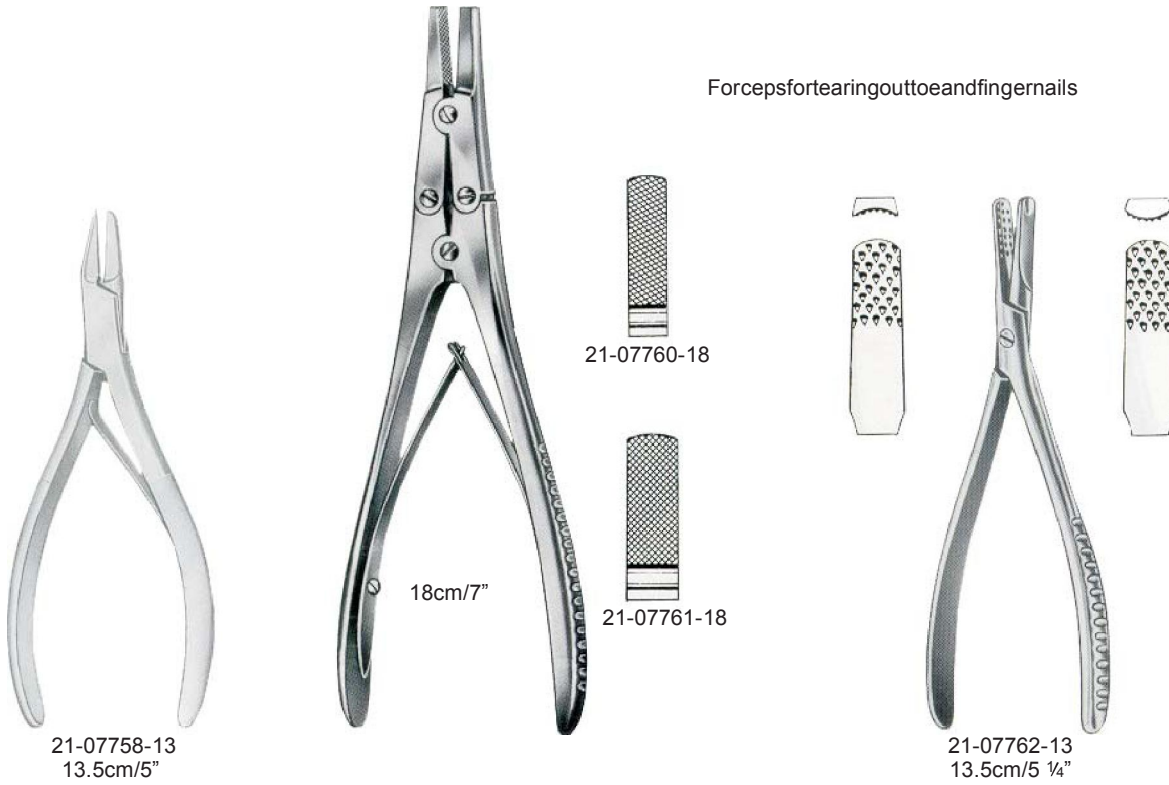

Sawblade



21-07764-17  
17cm/6 3/4"

Sawblade



21-07766-17  
17cm/6 3/4"





**Langenbeck**  
21-07768-23  
23cm/9"



**Satterlee**  
21-07770-31  
31cm/12 1/4"



**Charriere**  
21-07772-27 27cm/10 1/2"  
21-07772-30 30cm/12"



**Charriere**

Sparesawblades  
21-07774-12 12mm  
21-07774-15 15mm  
Completo with 2 blades  
21-07774-35



**Helferich-Bier**

Sparesawblades  
21-07776-43 3mm  
21-07776-45 5mm  
21-07776-47 7mm  
Completo with 3 blades  
21-07776-39



Hudson  
21-07778-00  
Handdrill, with 4 burrs, fig. 1-4

**Handle, only**  
21-07778-10

Conicalandsphericalburrs,single

Flattrephine

Extensionpiece



Fig.1  
21-07778-01  
9mm Ø



Fig.2  
21-07778-02  
14mm Ø



Fig.3  
21-07778-03  
16mm Ø



Fig.4  
21-07778-04  
22mm Ø



**Cushing**  
Fig.5  
21-07778-05  
14mm Ø

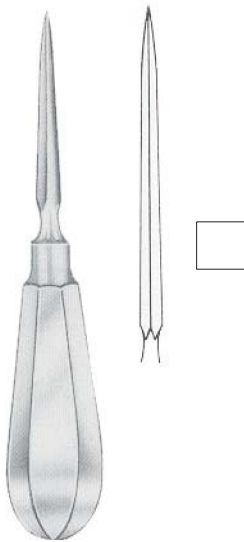

Fig.6  
21-07778-06

Drillguideandduraprotectingforceps



**Adson**  
21-07780-15  
15cm/6"



21-07784-14  
14cm/5 1/2"



**Perthes**  
21-07786-21  
21cm/8 1/4"

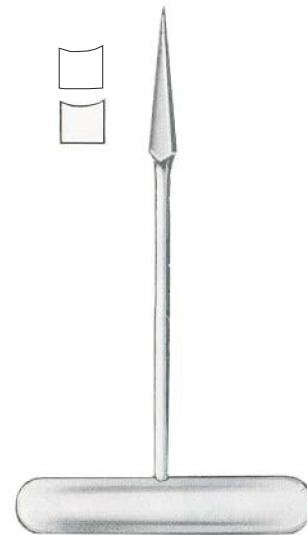

21-07788-14  
14cm/5 1/2"



21-07792-14  
14cm/5 1/2"

21-07794-16  
16cm/6 1/4"

18cm/7"

### PinsmedTC

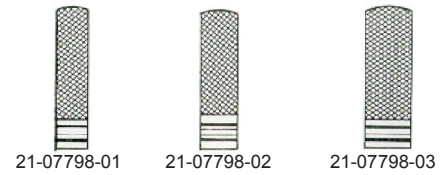

21-07798-01

21-07798-02

21-07798-03

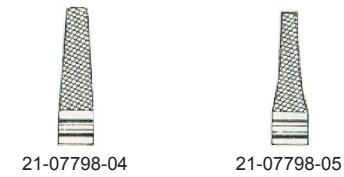

21-07798-04

21-07798-05

### PinsmedTC



21-07802-18 18cm/7"  
21-07802-20 20cm/8"

### PinsmedTC



21-07806-16  
15cm/6"

21-07806-20  
20cm/8"

21-07810-16  
15cm/6"



21-07814-13 13cm/5"  
21-07814-18 18cm/7"



21-07818-17  
17cm/6 3/4"



21-07822-15  
15.5cm/6"



21-07826-17 17cm/6 3/4" 21-07828-17

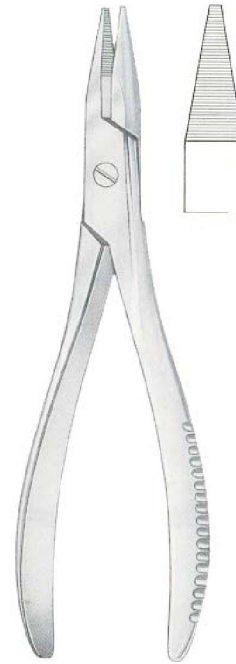

21-07830-19  
19cm/7 1/2"



Forswire  
withdiam.ofmax.

21-07834-15  
15cm/6"  
2.0mm

21-07836-18  
18.5cm/7 ¼"  
1.7 mm

21-07837-16  
16cm/6 ¼"  
2.0 mm

Forhardwire  
withdiam.ofmax.

1.5mm

1.7 mm

2.0 mm



## PinsmedTC



21-07840-12  
0.7mm  
0.5mm  
12cm/4 3/4"



21-07844-15  
2.0mm  
1.0mm  
15cm/6"



21-07848-18  
2.0mm  
1.7mm  
18cm/7"



21-07852-18  
2.5mm  
1.5mm  
18.5cm/7 1/4"



21-07856-18  
2.0mm  
1.7mm  
18cm/7"

21-07860-22  
3.0mm  
2.5mm  
22cm/8 3/4"



21-07864-22  
3.0mm  
22cm/8 3/4"



With1Pin

**Bohler**

cm	in	
hxb	hxb	ForArm
16x9	6¼x3 ½	21-07868-16

cm	in	
		ForThighandKnee
21x11	8¼x4 ½	21-07868-21

With3TractionHooks



**Kirschner**

ClearWidth	cm	in
21-07872-01	9.5x7	3¾x2¾
21-07872-02	10.5x10.5	4¼x4¼
21-07872-03	12x12	4¾x4¾
21-07872-04	15.5x15.5	6x6
21-07872-05	20x15.5	8x6

With3TractionHooks



ClearWidth

	cm	in
21-07876-18	18x10	07x04
21-07876-27	27x16	10½x06¼



**Kirschner**

21-07880-01	SmallPattern
21-07880-02	MediumPattern
21-07880-03	LargePattern

ScrewNutWrench



21-07884-10  
10cm/4"

ScrewDriver



21-07884-12  
12cm/4 3/4"

WireStrainer



21-07884-20  
20cm/8"

FixationDiscsForDrillWires



21-07884-30  
Pair



21-07884-40



21-07884-42

FixationDiscs



21-07884-51  
Pair

BoneWireGuides



BoneWireTighteners

**Loute**  
21-07888-00  
21cm/8 1/4"



Demel

BoneWireGuides

Fig. 121-07892-01  
Fig. 221-07892-02  
Fig. 321-07892-03

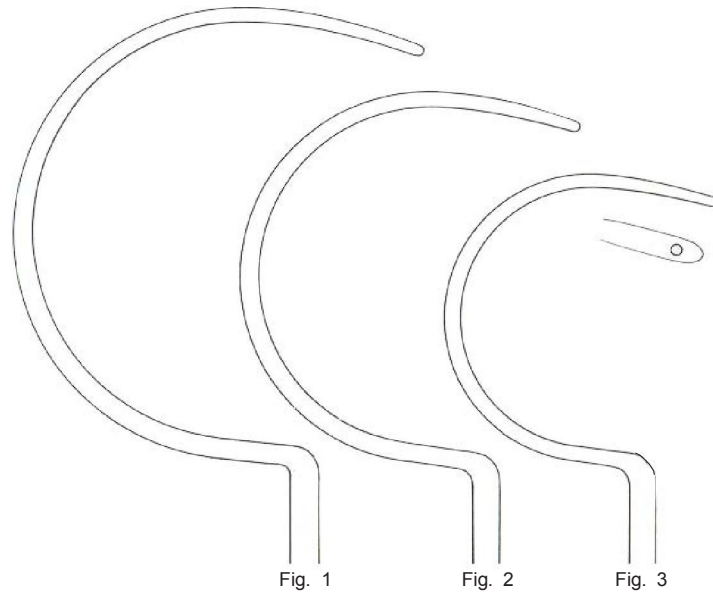

Fig. 1

Fig. 2

Fig. 3



100g21-07896-10  
350g21-07896-35  
500g21-07896-50  
700g21-07896-70

22cm/8 1/2"

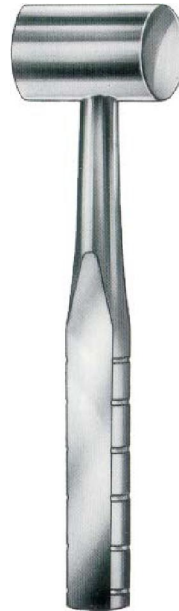

**Heath**  
21-07900-18  
18cm/7" Ø40mm

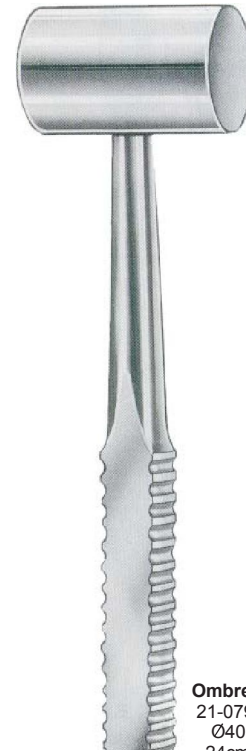

**Ombredanne**  
21-07904-24  
Ø40mm  
24cm/9 1/2"  
550g



**Williger**  
21-07912-23  
23cm/9"  
150g



**Hajek**  
21-07916-21  
Ø27mm  
21cm/8 1/4"  
140g



1SideFlat  
1SideConvex

**Cottle**  
21-07908-19  
Ø30mm  
19cm/7 1/2"  
350g



165g  
Ø22mm

21-07920-19  
19cm/7 1/2"



Fig. 121-07924-1919mmO /  
Fig. 221-07924-2525mmO /

**Lucae**  
19cm/7 1/2"



21-07928-16  
16.5cm/6 1/2"



320g  
Ø26mm

SolidWith  
Interchangeable  
FerrozellJaws

**Mead**  
21-07932-17  
17cm/6 3/4"



280g  
SolidSteel

**Gardner**  
21-07936-14  
14cm/5 1/2"



200g  
22mmO/  
(7oz.)

**Partsch**  
21-07940-18  
18cm/7"



**Gerzog**  
21-07944-19  
19cm/7 1/2"





21-07948-34  
34cm/13½"

Tendon Passing Instruments

Malleable



**Bunnell**  
21-07950-1818cm/7"  
21-07950-2323cm/9"

Tendon Strippers

mmO/  
4.021-07952-40  
4.521-07952-45  
5.521-07952-55  
FlexibleShaft



**Bunnell**  
23cm/9"



**Fischer**  
21-07956-31  
31cm/12 ¼"



**Brand**

21-07960-50  
50cm/19 ½"  
06mmO/

21-07962-30  
30cm/12"  
03mmO/



**Brand**  
21-07964-50  
50cm/19 ½"

6x14mm



**Steinmann**  
21-07968-16  
16cm/6 1/4"



**Larsen**  
10cm/4"



**Kleinert-Kutz**  
21-07976-20  
20cm/8"



**Brand**  
21-07980-1515cm/6"  
21-07980-1919cm/7 1/2"  
21-07980-2424cm/9 1/2"

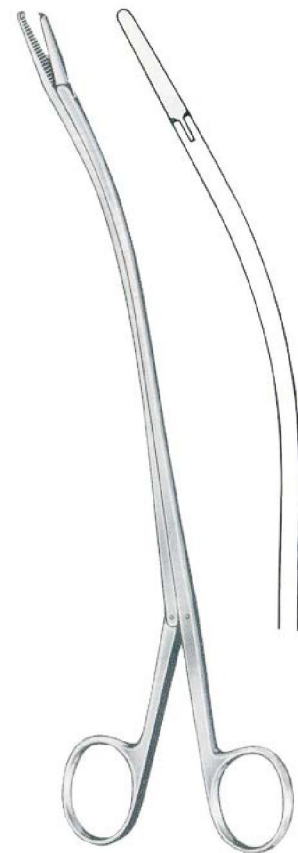

**Brand**  
21-07981-1515cm/6"  
21-07981-1919cm/7 1/2"  
21-07981-2424cm/9 1/2"

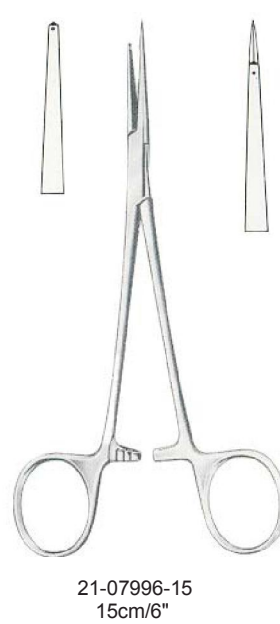
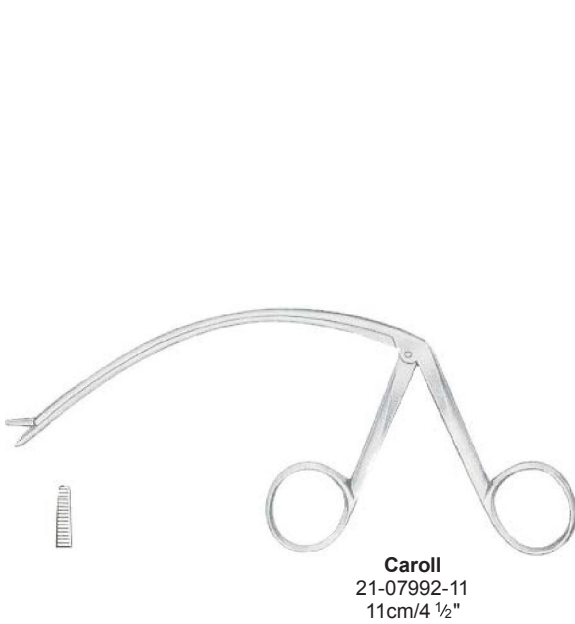
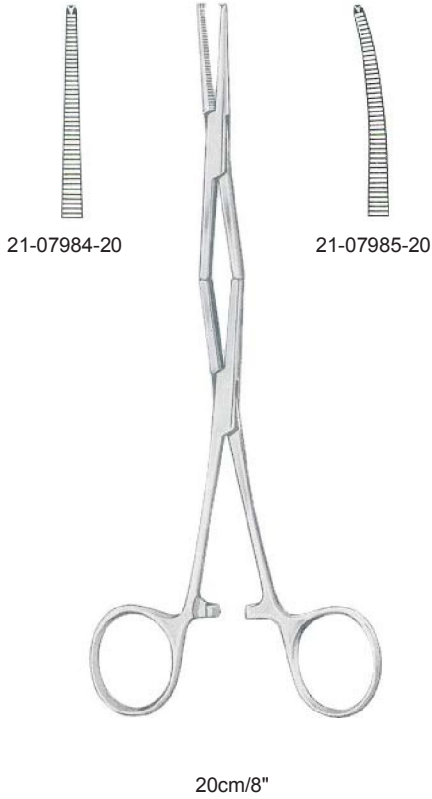

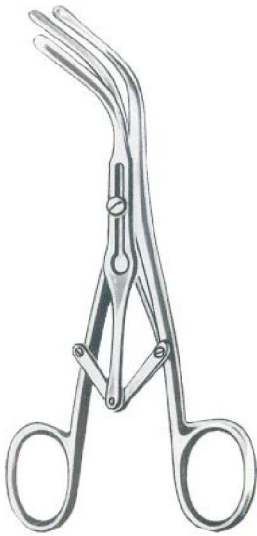

**Laborde**  
 22-08000-13 13cm/5"  
 22-08000-15 15cm/6"



**Trousseau**  
 22-08004-14  
 14cm/5 1/2"



**Trousseau-Baby**  
 22-08006-13  
 13cm/5"

Hooks

Left

Right

Sharp

Thyroid Gland Retractor

Trachea Trocars



**Bose**  
 22-08010-07  
 7cm/2 3/4"



22-08013-16



22-08015-16











**Bose**  
 16cm/6 1/4"



**Schoenborn**  
 22-08018-21  
 21cm/8 1/4"



**Uckerman**  
 22-08022-08 08mmO/  
 22-08022-10 10mmO/  
 13cm/5"

Fig	0	1	2	3	4	5	6	7	8	9
										
Ømm	04	05	06	07	08	09	10	11	12	13
Charr./Fr.	12	15	18	21	24	27	30	33	36	39
	45	50	55	60	65	70	75	80	85	90

Length of Outer Tube

Standard Pattern



Luer

Fig.	mmØ	
0	4	22-08026-04
1	5	22-08026-05
2	6	22-08026-06
3	7	22-08026-07
4	8	22-08026-08
5	9	22-08026-09
6	10	22-08026-10
7	11	22-08026-11
8	12	22-08026-12
9	13	22-08026-13

Chevalier-Jackson



Luer

Fig.	mmØ	
0	4	22-08028-04
1	5	22-08028-05
2	6	22-08028-06
3	7	22-08028-07
4	8	22-08028-08
5	9	22-08028-09
6	10	22-08028-10
7	11	22-08028-11
8	12	22-08028-12
9	13	22-08028-13



Luer

Fig.	mmØ	
4	8	22-08030-08
5	9	22-08030-09
6	10	22-08030-10
7	11	22-08030-11
8	12	22-08030-12
9	13	22-08030-13



GoitreProbes

**Kocher**

23-08034-1515cm/6"  
23-08034-1616cm/6 1/4"



GoitreGraspingForceps

**Lahey**

23-08038-1515cm/6"  
23-08038-2020cm/8"



**MuscleForceps**

23-08042-17

**Mastin**  
17cm/6 3/4"



## Comedone Extractors

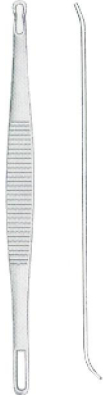

**Schamberg**  
 24-08046-10  
 10cm/4"



**Unna**  
 24-08050-14  
 14cm/5 1/2"



**Unna**  
 24-08052-14  
 14cm/5 1/2"



**Sealfeld**  
 24-08056-10  
 10cm/4"



**Saalfeld**  
 24-08060-14  
 14cm/5 1/2"



**Katsch**  
 24-08064-14  
 14cm/5 1/2"

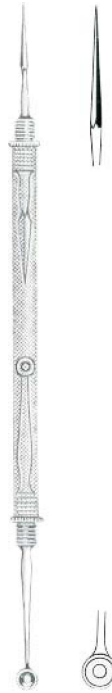

**Hebra**  
 24-08068-18  
 18cm/7"



**Piffard**  
 14.5cm/5 3/4"

## Skin Curettes



Fig.124-08072-01

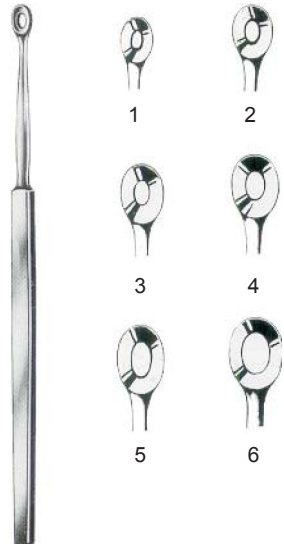

Fig.224-08072-02



Fig.324-08072-03

## LupusCurettes



**Wolff**  
14cm/5 1/2"

- Fig.  
1 24-08076-01  
2 24-08076-02  
3 24-08076-03  
4 24-08076-04  
5 24-08076-05  
6 24-08076-06

## LupusCurettes

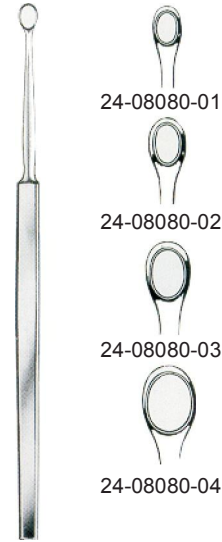

**Fox**  
14cm/5 1/2"

## LupusScraper



**Vidal**  
24-08084-14  
14cm/5 1/2"

## MoncorpsKnife



**Moncorps**  
24-08088-14  
14cm/5 1/2"



**Gillies**  
Fig.124-08092-01  
Fig.224-08092-02  
18cm/7"

## CutaneousHook



**Kilner**  
24-08094-15  
15cm/6"



		Allis	
		4:5	5:6
cm	in		
15	6"	25-08096-15	25-08100-15
19	7½"		25-08100-19
23	9"		25-08100-23
25	10"		25-08100-25



		Baby-Allis	
		25-08104-12	12cm/4 ¾"
		25-08104-14	14cm/5 ½"



		Allis-Atrauma	
		25-08108-16	16cm/6 ¼"
		25-08108-20	20cm/8"
		25-08108-25	25cm/10"
		25-08108-30	30cm/12"



**Allis-Adair**  
 25-08112-15  
 15cm/6"



**Baby-Allis**  
 25-08116-15  
 15cm/6"



**Lockwood-Allis**  
 25-08120-16 16cm/6 ¼"  
 25-08120-20 20cm/8"



**Thoms-Allis**  
 25-08124-20  
 20cm/8"



**PinsmedAtrauma**

**PinsmedTc**



**PinsmedAtrauma**

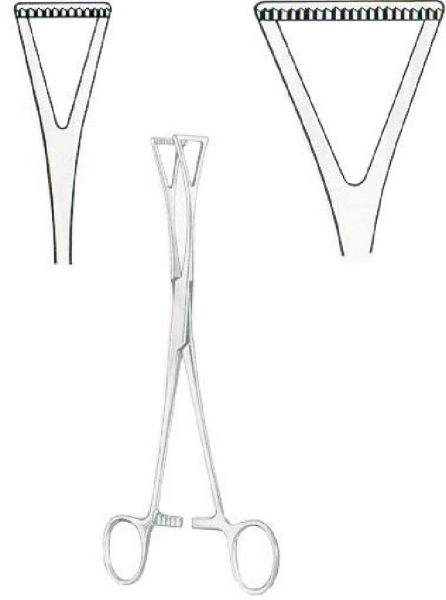

	Duval		
	cm	in	
25-08164-18	18	7"	
25-08164-20	20	8"	25-08168-20
25-08164-23	23	9"	25-08168-23

**PinsmedTC**

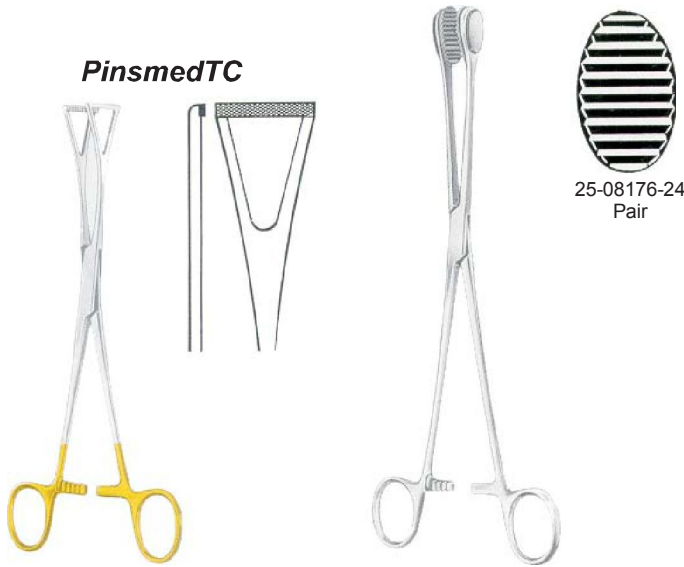

**Duval**  
 25-08172-20  
 20cm/8"

**Child**  
 24cm/9 1/2"

**PinsmedAtrauma**

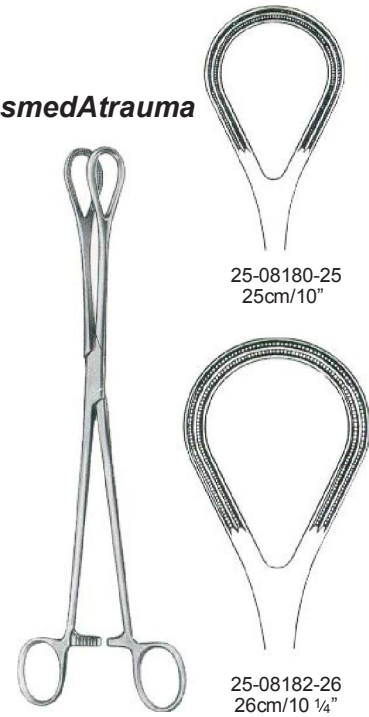

25-08180-25  
 25cm/10"

25-08182-26  
 26cm/10 1/4"

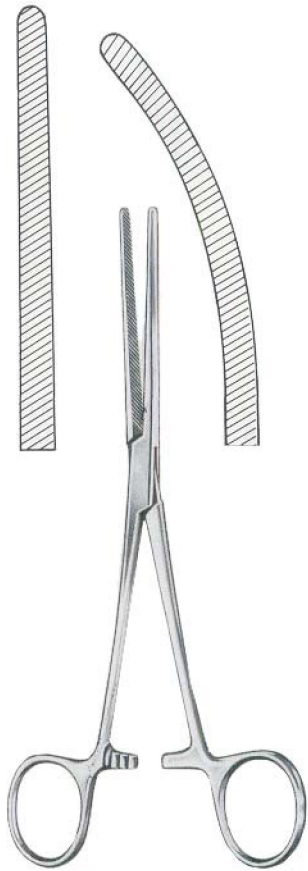

**Baby-Doyen**  
 Straight 25-08186-18 18cm/7"  
 Curved 25-08187-18 18cm/7"

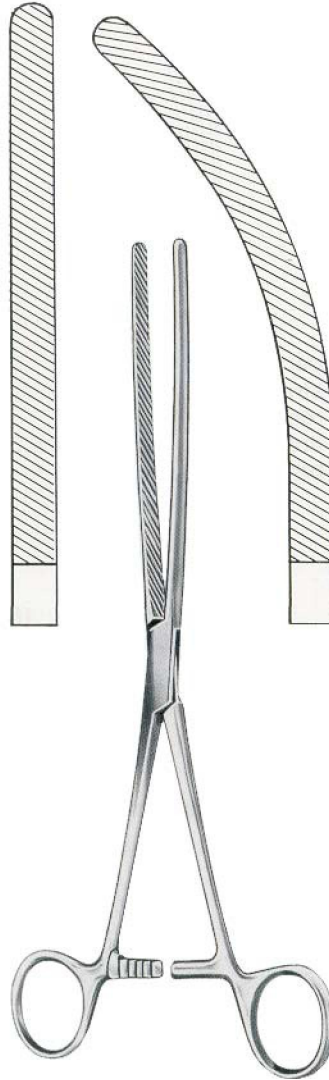

**Doyen**  
 Straight 25-08190-21 21cm/8 1/4"  
 25-08190-23 23cm/9"  
 Curved 25-08191-21 21cm/8 1/4"  
 25-08191-23 23cm/9"

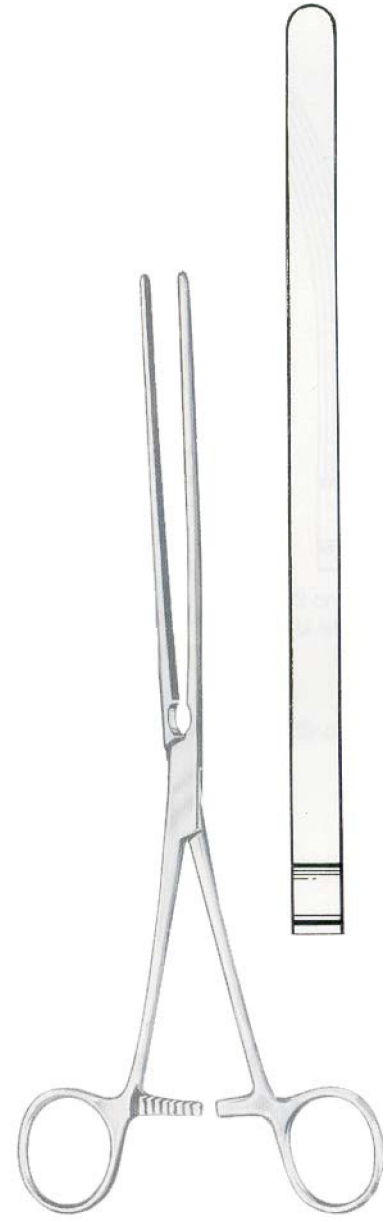

**Scudder**  
 25-08194-25 25cm/10"



**PinsmedAtrauma**



**Doyen-Atrauma**

Straight

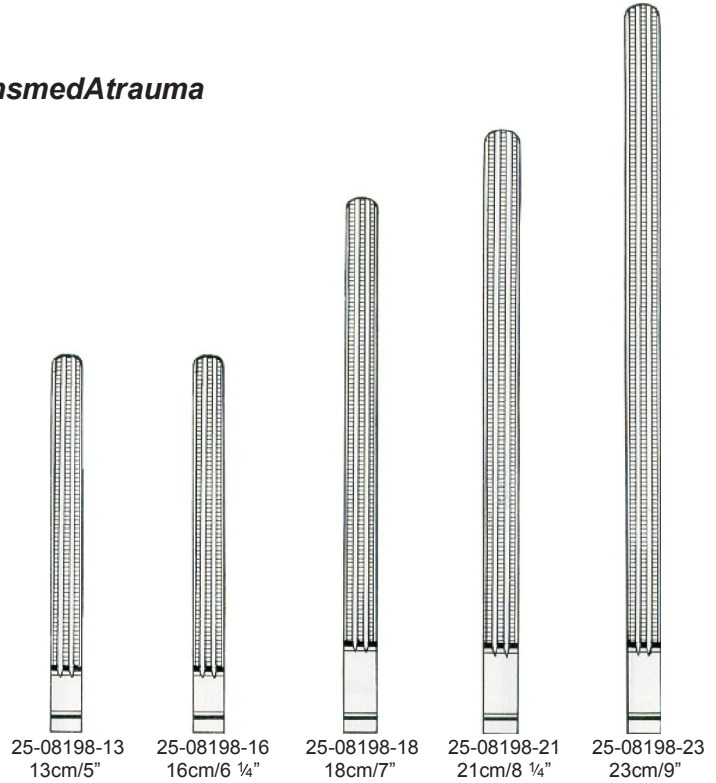

**PinsmedAtrauma**

Curved

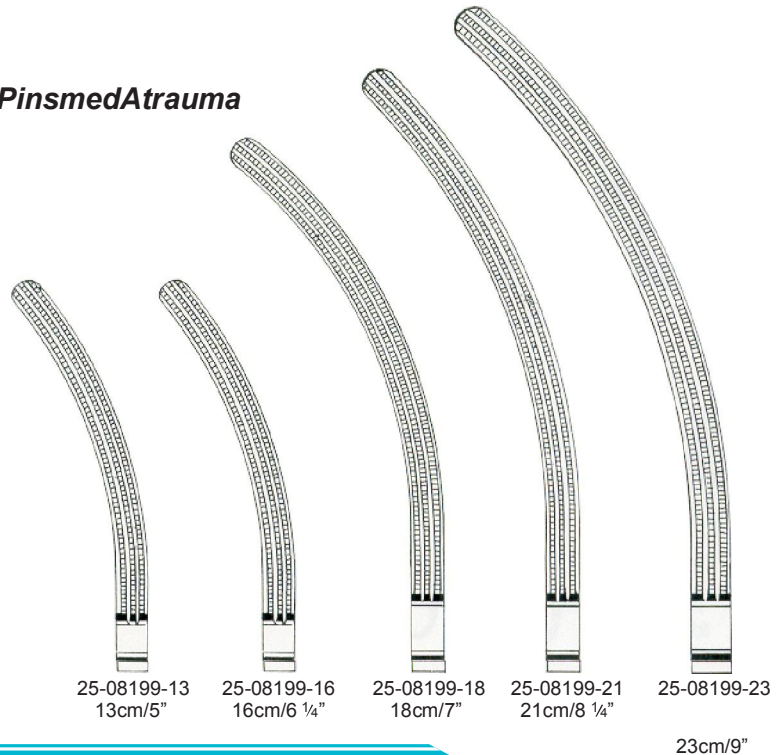



Mayo-Robson  
 Mayo-RobsonAtrauma

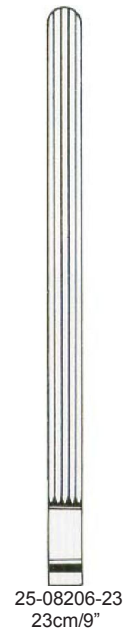
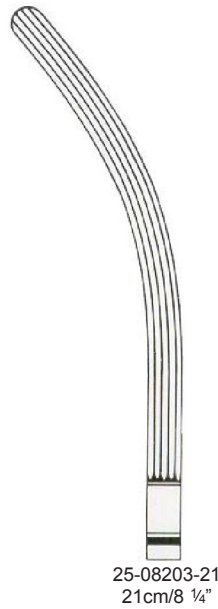
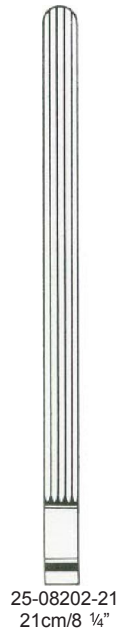

**PinsmedAtrauma**

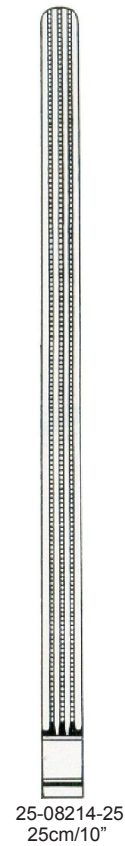
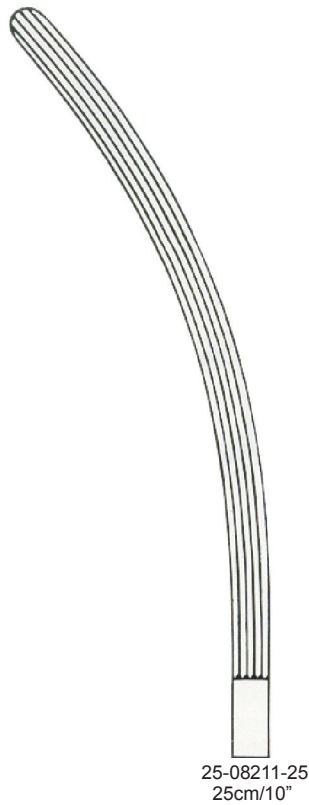



**Resano**  
 25-08219-30  
 30cm/12"



**Hayes**

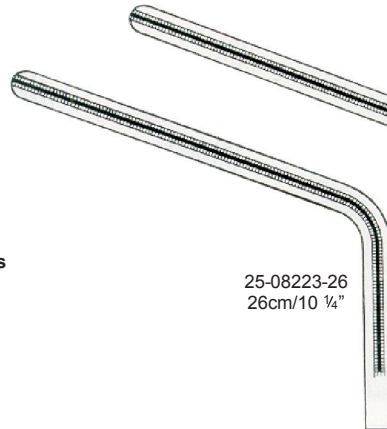

25-08223-26  
 26cm/10 ¼"

**PinsmedAtrauma**

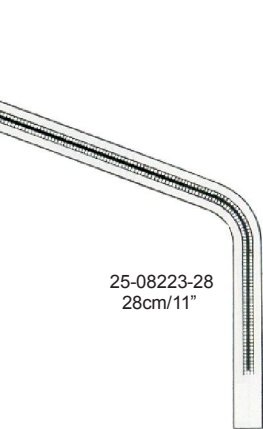

25-08223-28  
 28cm/11"



**Fehland**  
 25-08227-24  
 24cm/9 ½"



**Brunner**  
 24cm/9 ½"

**PinsmedAtrauma**

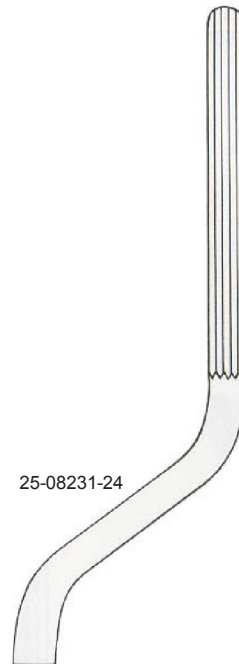

25-08231-24

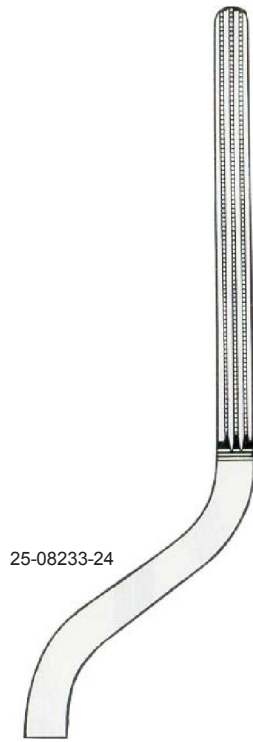

25-08233-24



Straight **Baby-Kocher** Curved  
 25-08236-13 25-08237-13  
 13cm/5" 13cm/5"



**Kocher**



25-08240-22  
 22cm/8 3/4"



25-08240-25  
 25cm/10"



25-08240-28  
 28cm/11"



25-08241-22  
 22cm/8 3/4"



25-08241-25  
 25cm/10"

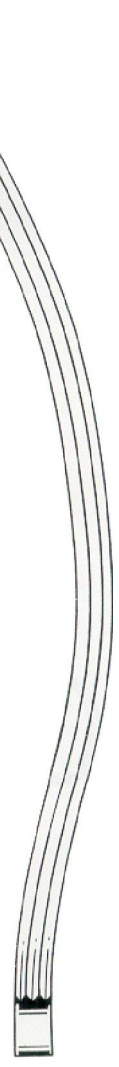

25-08241-28  
 28cm/11"

*PinsmedAtrauma*



**Kocher-Atrauma**



25-08244-22  
22cm/8 3/4"

25-08244-25  
25cm/10"

25-08244-28  
28cm/11"

25-08245-22  
22cm/8 3/4"

25-08245-25  
25cm/10"

25-08245-28  
28cm/11"





**Straight**  
25-08248-25



**Nussbaum**  
25cm/10"



**Curved**  
25-08249-25



**Benson**  
25-08252-15  
15.5cm/6"

Pylorusspreader



**Allen**  
25-08253-15 15.5cm/6"  
25-08253-20 20.0cm/8"

Blindgutforceps



**Kleinschmidt**  
25-08255-12  
12cm/4 3/4"





**Payr**  
(Payr-Baby)

For children

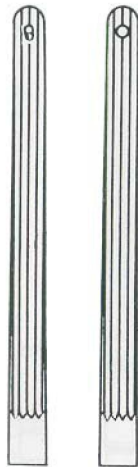

25-08258-15  
15cm/6"

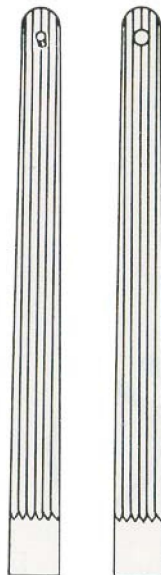

25-08258-21  
21cm/8 1/4"

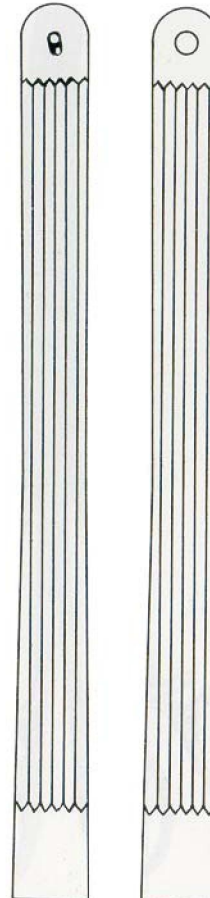

25-08258-29  
29cm/11 1/2"

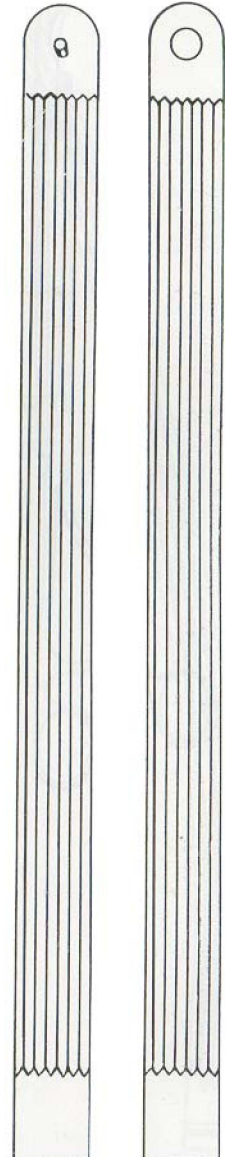

25-08258-35  
35cm/13 3/4"

TwinClampsForceps



Lane  
30cm/12"



Straight  
25-08862-30

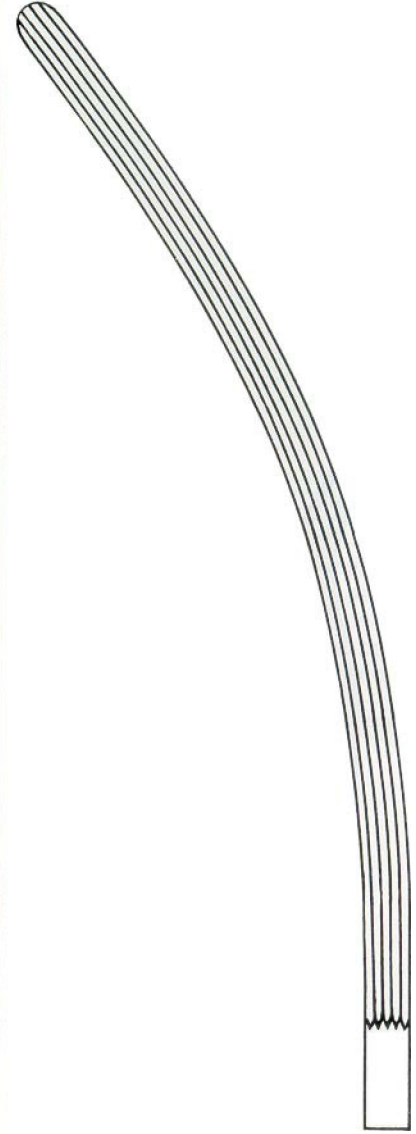

Curved  
25-08863-30

*PinsmedAtrauma*



IntestinalandStomachTwinClamps



**Haberer**  
 25-08274-36  
 36cm/14"

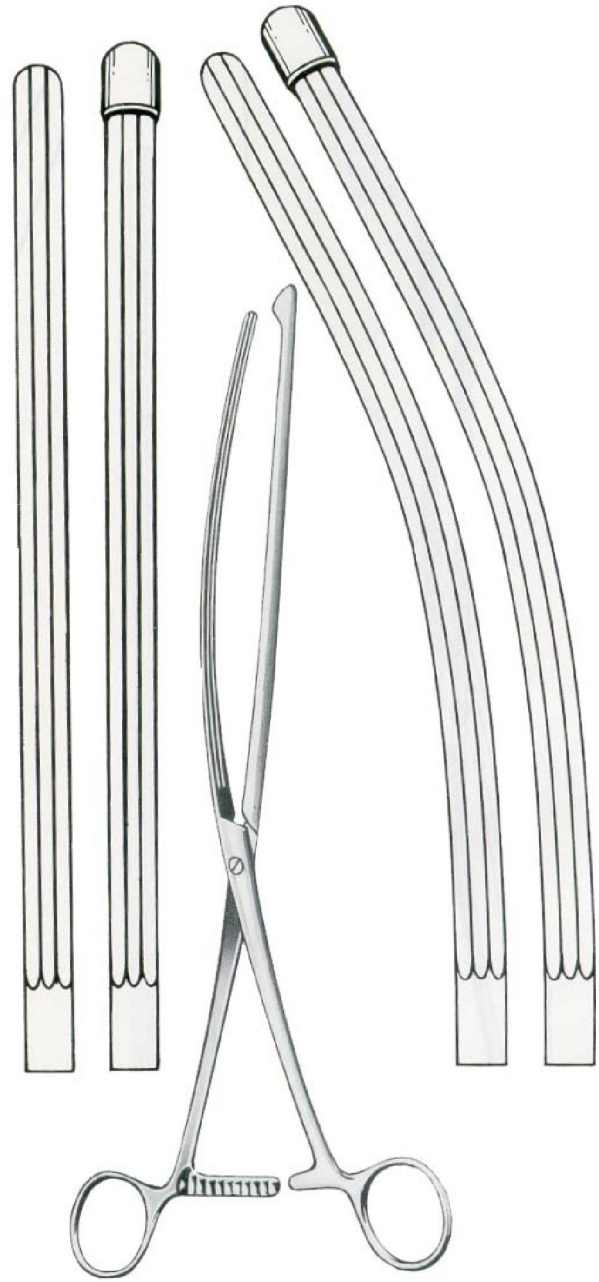

**Straight**  
 25-08278-30

**Nussbaum**  
 30cm/12"

**Curved**  
 25-08279-30



**Czerny**  
 25-08282-22  
 22cm/8 3/4"



**Pratt**  
 25-08286-20  
 80x25mm  
 20.5cm/8"



**Sims**  
 25-08291-15  
  
**(Bodenhammer)**  
**Sims**  
 25-08290-15  
 15cm/6"



Length of Blades  
 25-08294-06 60mm  
 25-08294-08 80mm  
 25-08294-12 125mm  
 25-08294-15 150mm

**Sims**  
 22cm/8 3/4"



**Mathieu**  
 25-08298-19  
 90x15mm  
 19.5cm/7 3/4"





**Barr**  
25-08302-17  
17cm/6 3/4"  
70X22mm



**Smith-Bule**  
25-08306-15  
15cm/6"

Anal Retractors

Anuscopes



Fig. 116mmOxø5mm  
Fig. 219mmOxø5mm  
Fig. 322mmOxø5mm  
Fig. 425mmOxø5mm

**Hirschmann**  
25-08310-01  
25-08310-02  
25-08310-03  
25-08310-04



Fig. 119mmOx70mm  
Fig. 222mmOx70mm

**Bensaude**  
25-08314-01  
25-08314-02



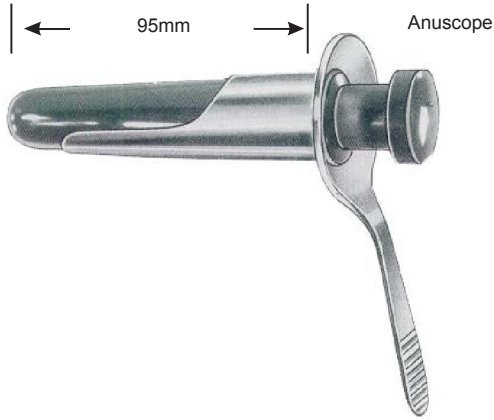

**Ives-Fansler**  
 25-08318-22  
 22mm Ø

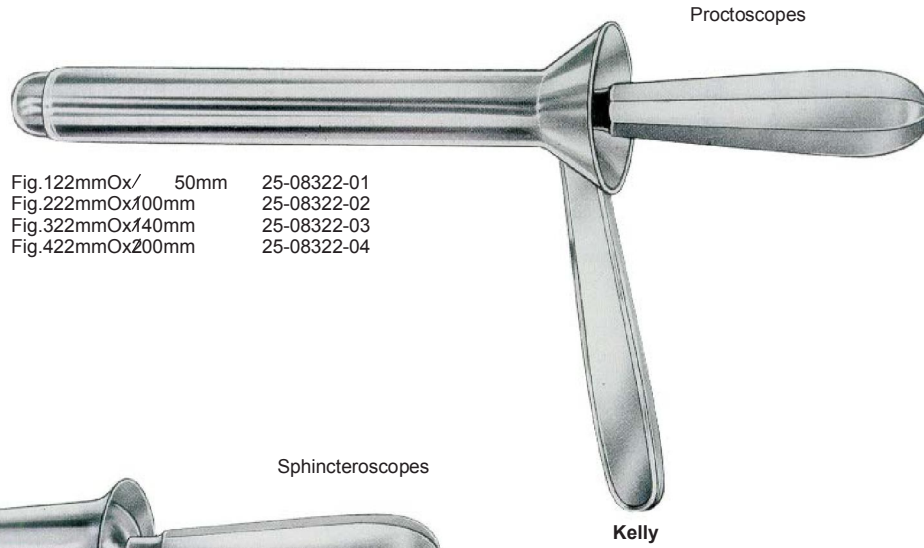
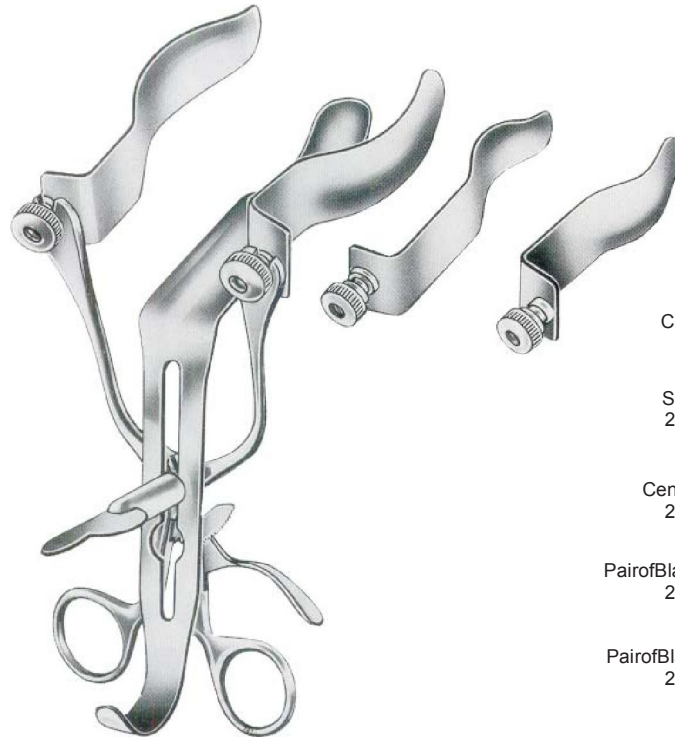

Fig.122mmOx/ 50mm 25-08322-01  
 Fig.222mmOx100mm 25-08322-02  
 Fig.322mmOx140mm 25-08322-03  
 Fig.422mmOx200mm 25-08322-04



Fig.121mmO50mm 25-08326-01  
 Fig.227mmO50mm 25-08326-02



Consistingof:

Speaderonly  
 25-08330-01

CenterBladeonly  
 25-08330-02

PairofBladesOnly75mm  
 25-08330-03

PairofBladesonly95mm  
 25-08330-04

**Park**  
 25-08330-00  
 14.5cm/5 3/4"



Consistingof:

Speaderonly  
 25-08334-01

PairofBladesonly95mm  
 25-08334-02

**Park**  
 25-08334-00  
 13cm/5"

LengthofShaft

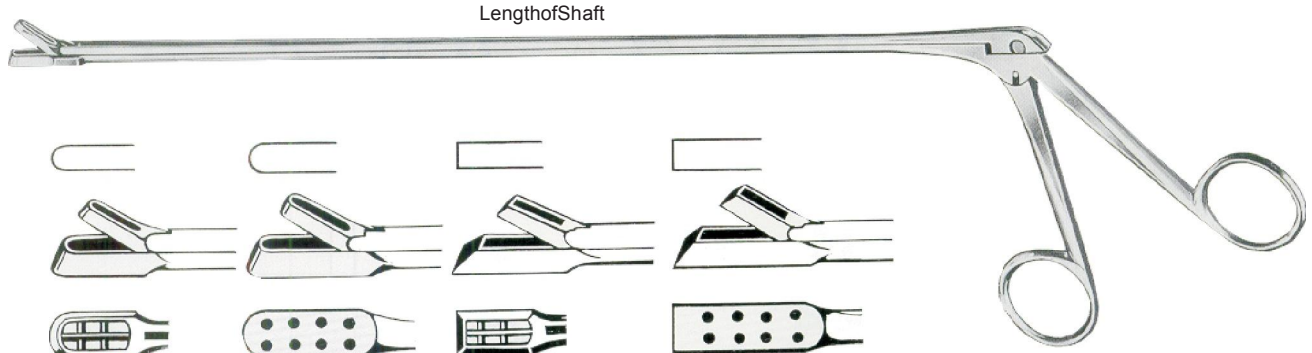



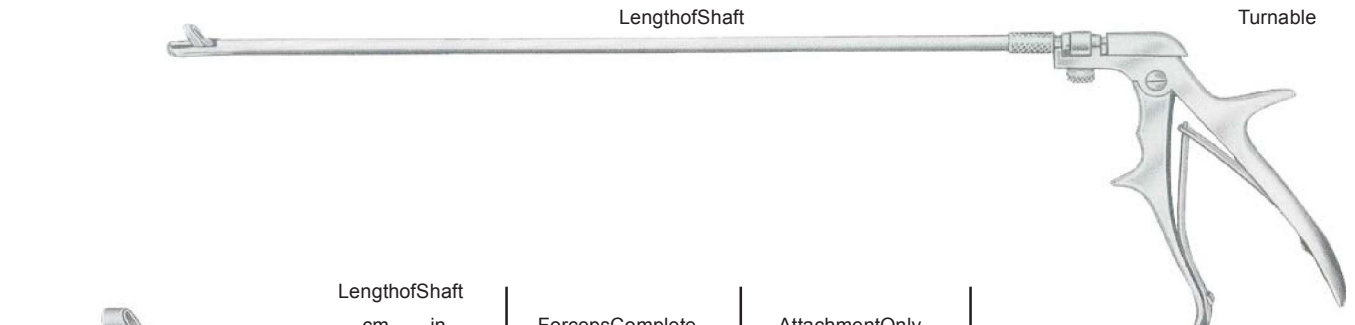

		cm	in	
1	2	28	11	<b>Yeoman</b>
25-08338-28	25-08340-28	35	13¾"	
25-08338-35	25-08340-35	42	16½"	
25-08338-42	25-08340-42			
3	4			
25-08342-28	25-08344-28			
25-08342-35	25-08344-35			
25-08342-42	25-08344-42			

LengthofShaft

Turnable



	LengthofShaft		ForcepsComplete	AttachmentOnly
	cm	in		
	33	13	25-08348-33	25-08358-33
	40	16	25-08348-40	25-08358-40
	33	13	25-08350-33	25-08360-33
	40	16	25-08350-40	25-08360-40
	33	13	25-08352-33	25-08362-33
	40	16	25-08352-40	25-08362-40
	33	13	25-08354-33	25-08364-33
	40	16	25-08354-40	25-08364-40

**Yeoman (Turrell)**  
HandleOnly  
25-08348-00

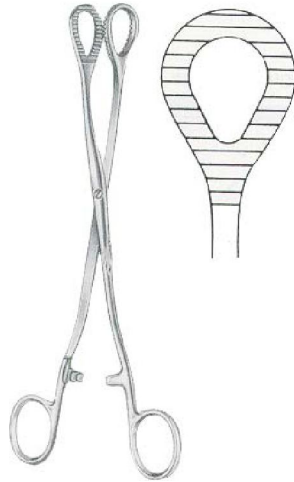

**Heywood-Smith**  
 25-08366-21  
 21cm/8 1/4"



**Heywood-Smith**  
 25-08368-21  
 21cm/8 1/4"

RectalSnare

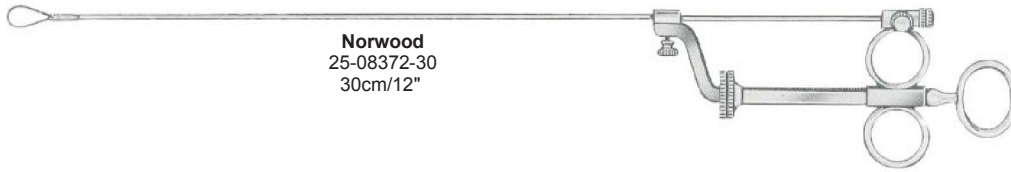

**Norwood**  
 25-08372-30  
 30cm/12"

RectalAspirationCannula

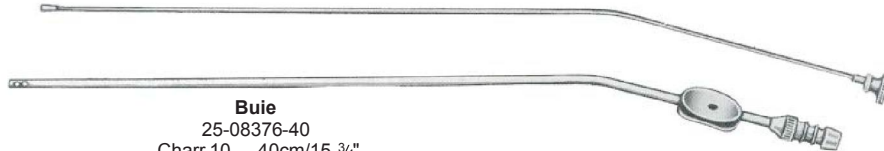

**Buie**  
 25-08376-40  
 Charr.10. 40cm/15 3/4"

RectalCoolers



25-08380-01



25-08380-02

AspirationTip

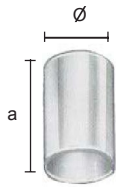

	a	Ø
25-08384-11	11mm	10mm
25-08384-16	16mm	10mm

ChargingCone



10mmO/

25-08392-10

ChargingCone



12mmO/

25-08392-12

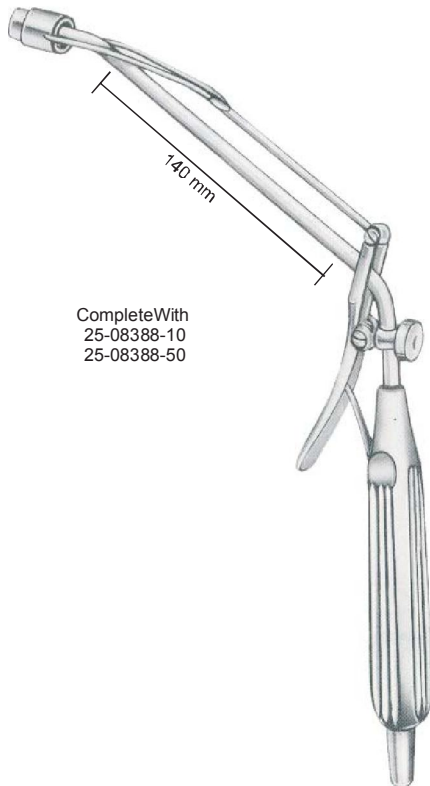

CompleteWith  
 25-08388-10  
 25-08388-50

CompleteWith  
 25-08396-00  
 25-08396-50

**Rudd**  
 31.5cm/12 1/2"

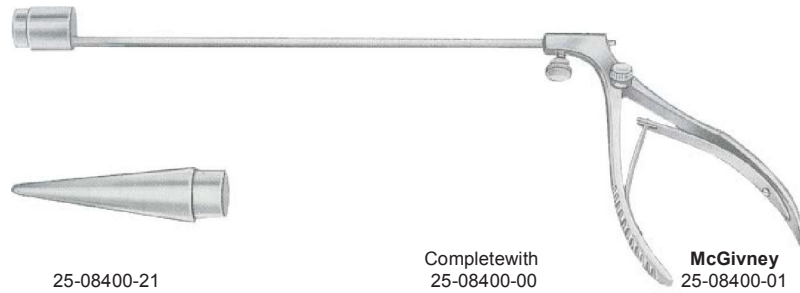

25-08400-21

Completo with  
25-08400-00

**McGivney**  
25-08400-01

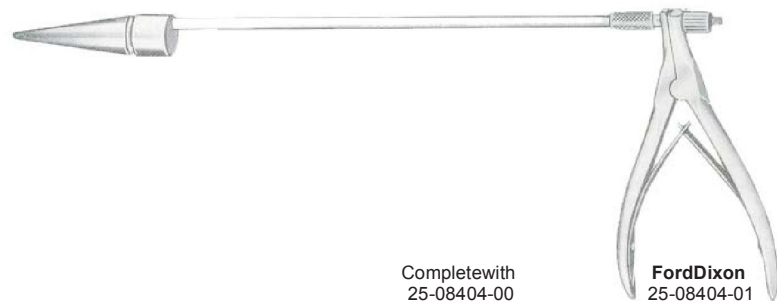

Completo with  
25-08404-00

**FordDixon**  
25-08404-01

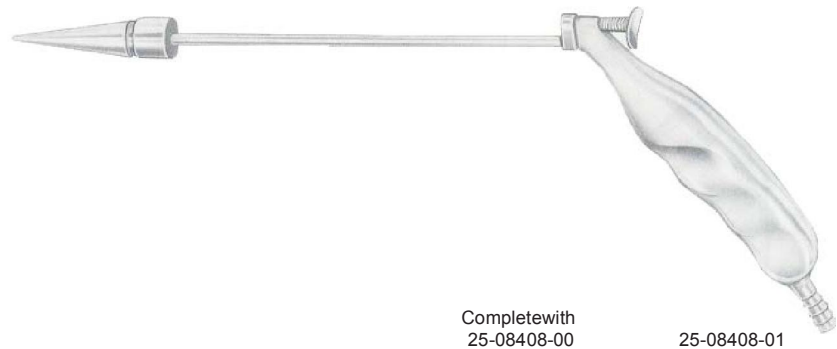

Completo with  
25-08408-00

25-08408-01



**McGivney**  
25-08412-19  
19cm/7 1/2"



25-08414-00  
Ligaturrubberings  
inboxof100pieces



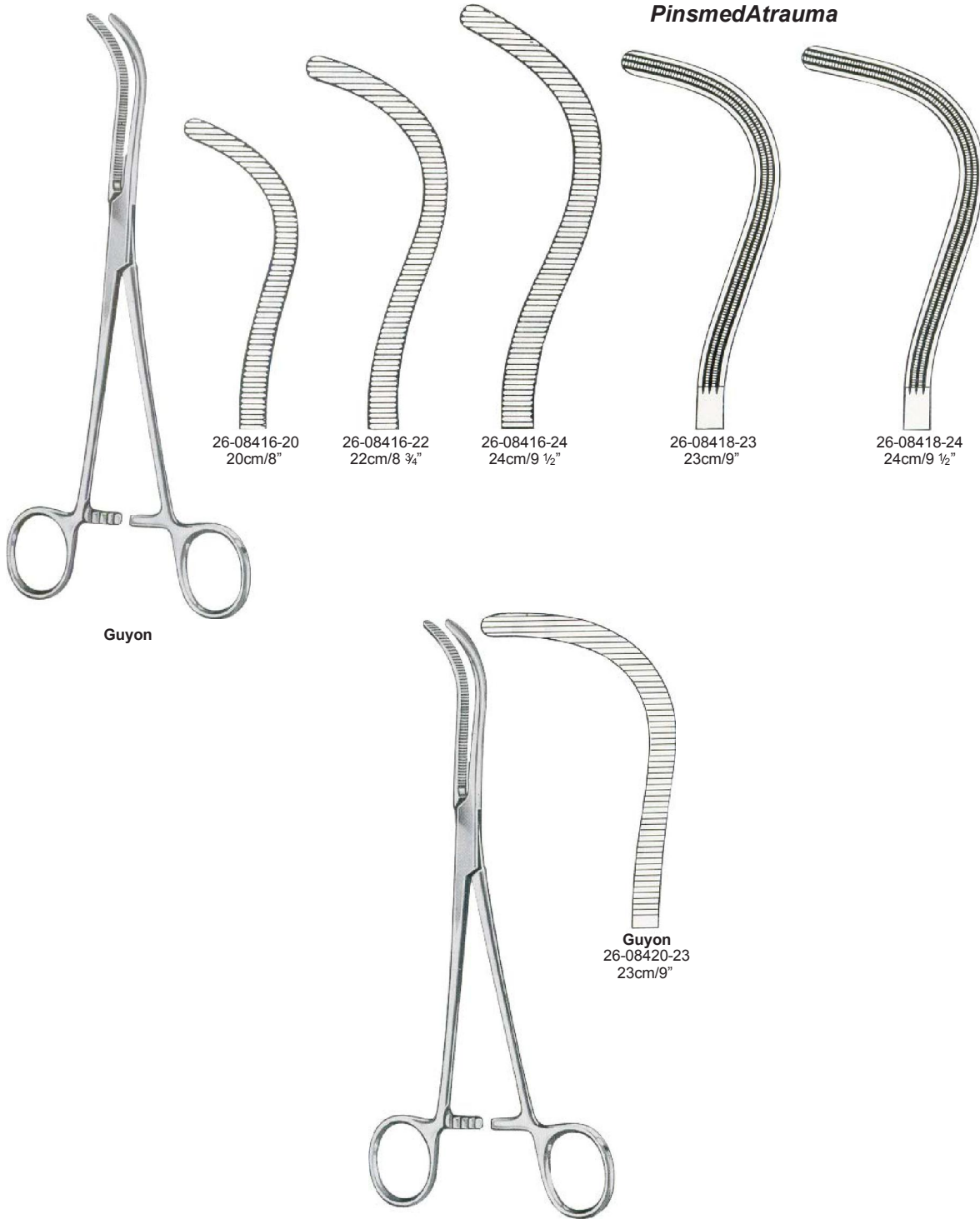



**Herrick**  
26-08424-23  
23cm/9"



**Mayo-Guyon**  
26-08428-23  
23cm/9"



**Stille**  
26-08432-23  
23cm/9"



**Elsasser**  
26-08436-20  
20cm/8"

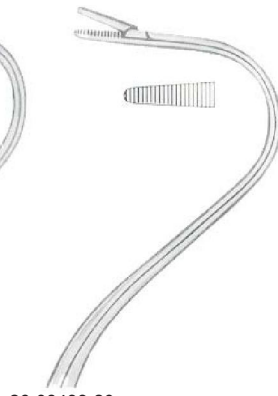

26-08438-20  
20cm/8"

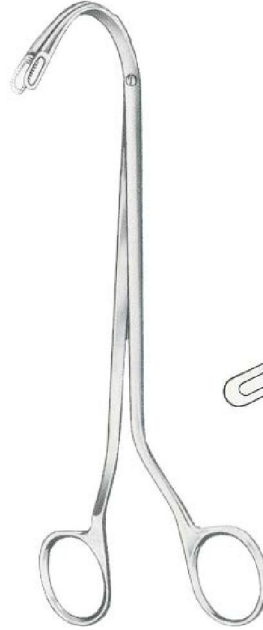

**Randall**

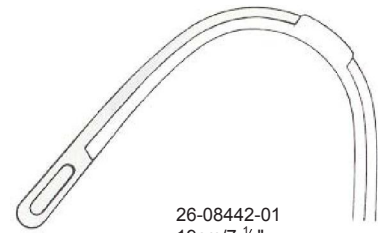

26-08442-01  
19cm/7 1/2"

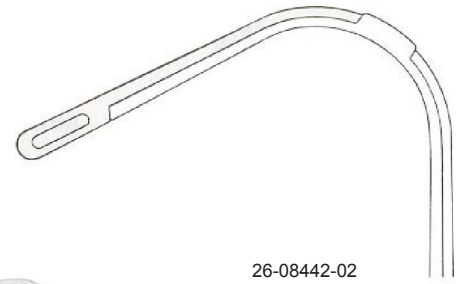

26-08442-02  
19cm/7 1/2"



**Randall**

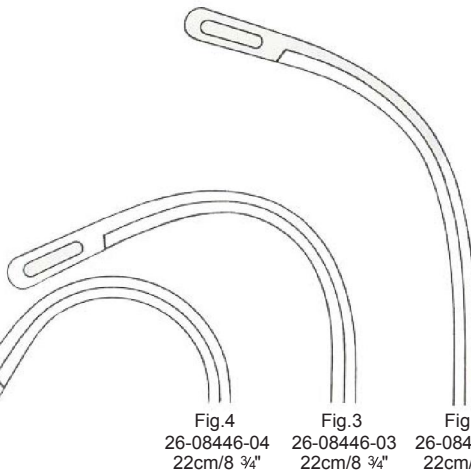

Fig.4  
26-08446-04  
22cm/8 3/4"

Fig.3  
26-08446-03  
22cm/8 3/4"

Fig.2  
26-08446-02  
22cm/8 3/4"

Fig.1  
26-08446-01  
23cm/9"



**Gray**  
26-08450-00

Fig.1  
26-08450-01  
22cm/8 3/4"

Fig.2  
26-08450-02  
23cm/9"

Set of 2 pieces



**Gray**  
26-08454-00

Fig.1  
26-08454-01  
22cm/8 3/4"

Fig.2  
26-08454-02  
23cm/9"

Set of 2 pieces



**Desjardins**  
26-08458-21  
21cm/8 1/4"

Gall duct and  
cystic forceps



**Nissen**  
26-08462-21  
21.5cm/8 1/2"



Straight **Blake** Curved  
26-08466-20 20cm/8" 26-08467-20



Straight **Mayo-Blake** Curved  
26-08472-20 20cm/8" 26-08473-20



**Czerny**  
26-08476-24  
24.5cm/9 3/4"



**Desjardins**  
23cm/9"



Fig. 1  
26-08480-01



Fig. 2  
26-08480-02



mm	
1	26-08488-01
2	26-08488-02
3	26-08488-03
4	26-08488-04
5	26-08488-05
6	26-08488-06
7	26-08488-07
8	26-08488-08
9	26-08488-09
10	26-08488-10
11	26-08488-11
12	26-08488-12
13	26-08488-13

26-08488-00  
setof9pieces

26-08488-03 to26-08488-11

26-08490-00  
setof9piecesincanvaspocket







**Mayo**  
26-08500-28  
28cm/11"

Malleable



**Mayo**  
26.5cm/10 1/2"



Fig.1  
26-08504-01



Fig.2  
26-08504-02



Fig.3  
26-08504-03



**Moore**  
26-08506-28  
28cm/11"

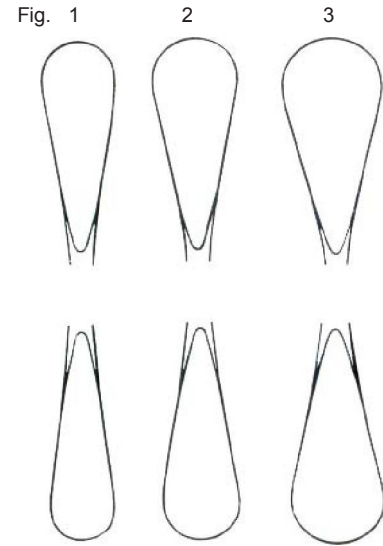
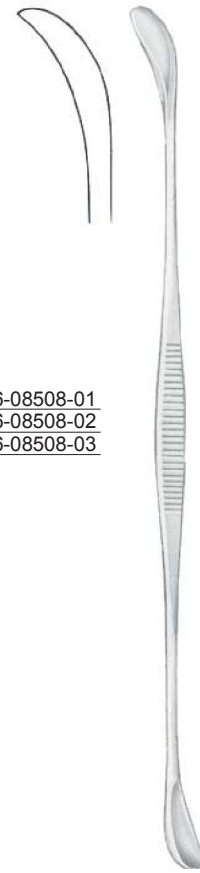

Fig.  
1 26-08508-01  
2 26-08508-02  
3 26-08508-03



**Fergusson**  
24cm/9 1/2"



**Young**  
26-08510-21  
21cm/8 1/4"



**Young**  
26-08512-22  
22cm/8 3/4"



**Young**  
26-08514-21  
21cm/8 1/4"



**Young**  
26-08514-22  
22cm/8 3/4"



**Millin**  
26-08516-23  
23cm/9"



**Millin**  
26-08518-23  
23cm/9"



**Millin**  
26-08520-23  
23cm/9"



**Millin**  
26-08522-24  
24cm/9 1/2"

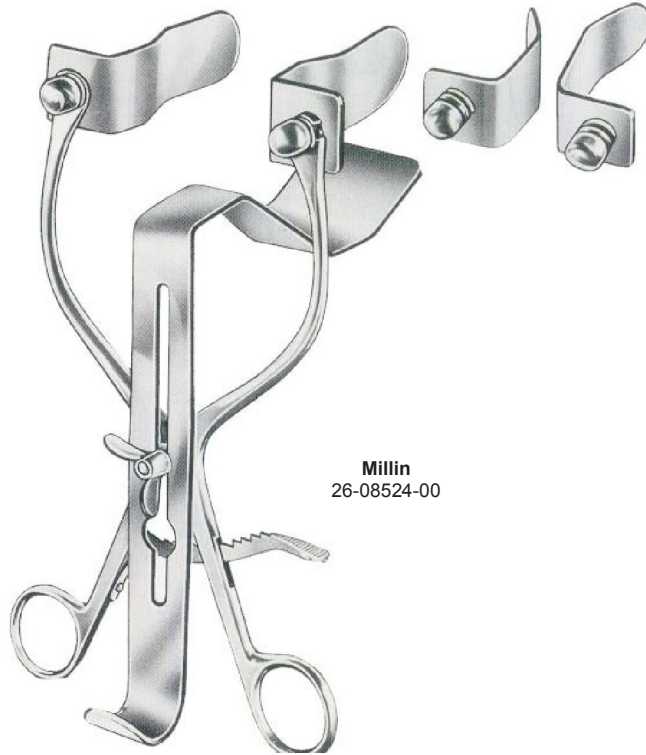

**Millin**  
26-08524-00



**Legueu**  
26-08528-00

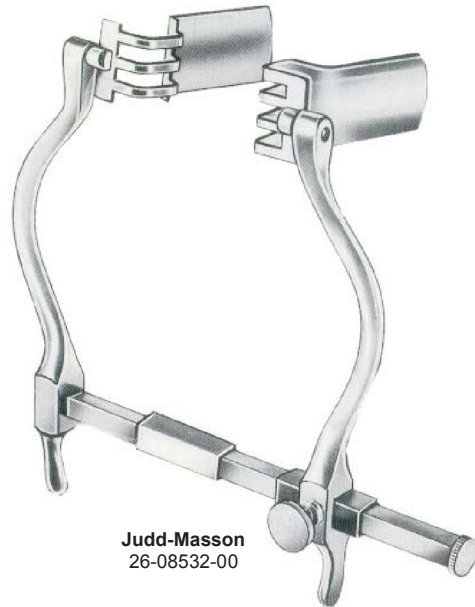

**Judd-Masson**  
26-08532-00

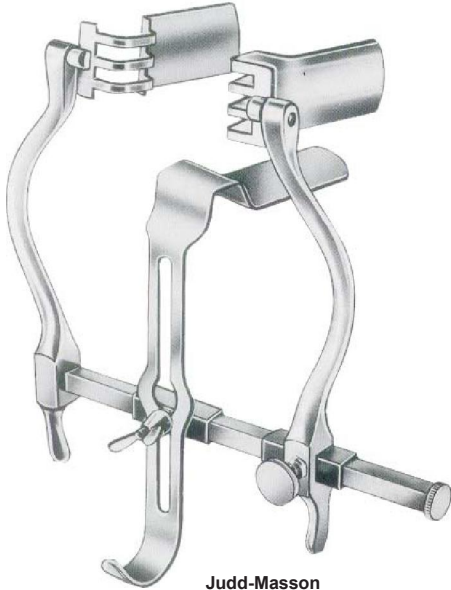

**Judd-Masson**  
26-08536-00



**Thomson-Walker**  
26-08540-00



**Legueu**  
26-08544-27  
27cm/10 1/2"  
35mm



**Kocher**  
26-08548-26  
26cm/10 1/4"  
67mm

**mm Ø**  
**Charriere (French)**

2 2/3	8
3	9
3 1/3	10
3 2/3	11
4	12
4 1/3	13
4 2/3	14
5	15
5 1/3	16
5 2/3	17
6	18
6 1/3	19
6 2/3	20
7	21
7 1/3	22
7 2/3	23
8	24
8 1/3	25
8 2/3	26
9	27
9 1/3	28
9 2/3	29
10	30
10 1/3	32
11 2/3	34
12	36



**VanBuren**  
Charriere(French)  
No.8-36  
26-08552-08  
26-08552-36  
28cm/11"  
InCanvasPouch  
26-08552-50  
Setof 6  
6Pcs.26-08552-14/24  
26-08552-24  
  
26-08552-60  
Setof 12  
12Pcs26-08552-08/30  
26-08552-36

26-08552-08
26-08552-10
26-08552-12
26-08552-14
26-08552-16
26-08552-18
26-08552-20
26-08552-22
26-08552-24
26-08552-26
26-08552-28
26-08552-30
26-08552-32
26-08552-34
26-08552-36



**Dittel**  
Charriere(French)  
No.8-30  
26-08554-08  
26-08554-30  
19.5cm/7 1/2"

**Straight**

26-08554-08
26-08554-09
26-08554-10
26-08554-11
26-08554-12
26-08554-13
26-08554-14
26-08554-15
26-08554-16
26-08554-17
26-08554-18
26-08554-19
26-08554-20
26-08554-21
26-08554-22
26-08554-23
26-08554-24
26-08554-25
26-08554-26
26-08554-27
26-08554-28
26-08554-29
26-08554-30

**Curved**

26-08556-08
26-08556-09
26-08556-10
26-08556-11
26-08556-12
26-08556-13
26-08556-14
26-08556-15
26-08556-16
26-08556-17
26-08556-18
26-08556-19
26-08556-20
26-08556-21
26-08556-22
26-08556-23
26-08556-24
26-08556-25
26-08556-26
26-08556-27
26-08556-28
26-08556-29
26-08556-30



**Dittel**  
Charriere(French)  
No.8-30  
26-08556-08  
26-08556-30  
34.5cm/13 1/2"



Formen



26-08560-06  
26-08560-24

	mmØ	Charriere (French)	
26-08560-06	2	6	26-08562-06
26-08560-07	2 $\frac{1}{3}$	7	26-08562-07
26-08560-08	2 $\frac{2}{3}$	8	26-08562-08
26-08560-09	3	9	26-08562-09
26-08560-10	3 $\frac{1}{3}$	10	26-08562-10
26-08560-11	3 $\frac{2}{3}$	11	26-08562-11
26-08560-12	4	12	26-08562-12
26-08560-13	4 $\frac{1}{3}$	13	26-08562-13
26-08560-14	4 $\frac{2}{3}$	14	26-08562-14
26-08560-15	5	15	26-08562-15
26-08560-16	5 $\frac{1}{3}$	16	26-08562-16
26-08560-17	5 $\frac{2}{3}$	17	26-08562-17
26-08560-18	6	18	26-08562-18
26-08560-19	6 $\frac{1}{3}$	19	26-08562-19
26-08560-20	6 $\frac{2}{3}$	20	26-08562-20
26-08560-21	7	21	26-08562-21
26-08560-22	7 $\frac{1}{3}$	22	26-08562-22
26-08560-23	7 $\frac{2}{3}$	23	26-08562-23
26-08560-24	8	24	26-08562-24

ForWomen



CatheterIntroducingInstruments



**Guyon**  
26-08566-39  
39cm/15 1/2"



**Guyon**  
26-08568-35  
35cm/13 3/4"

### CircumcisionInstruments

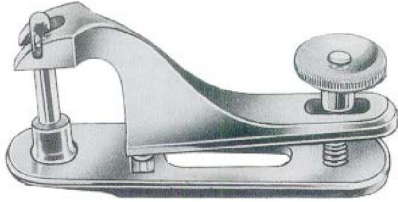

26-08572-08	08mm
26-08572-11	11mm
26-08572-13	13mm
26-08572-16	16mm
26-08572-21	21mm
26-08572-26	26mm
26-08572-32	32mm

### ForeignBodyForceps

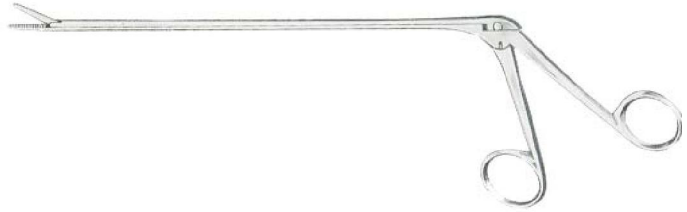

**Mathieu**  
26-08584-20

### PenisClamps

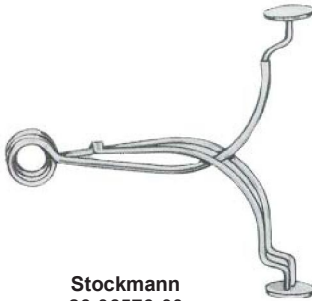

**Stockmann**  
26-08576-00

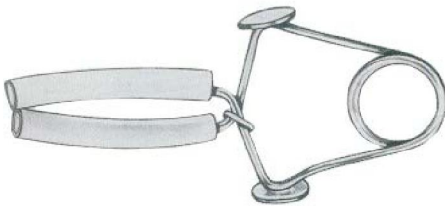

**Strauss**  
26-08580-00

### SecretionScoop



**Guttman**  
26-08588-26  
26.5cm/10 1/2"

Scheme of Dimensions for Specula

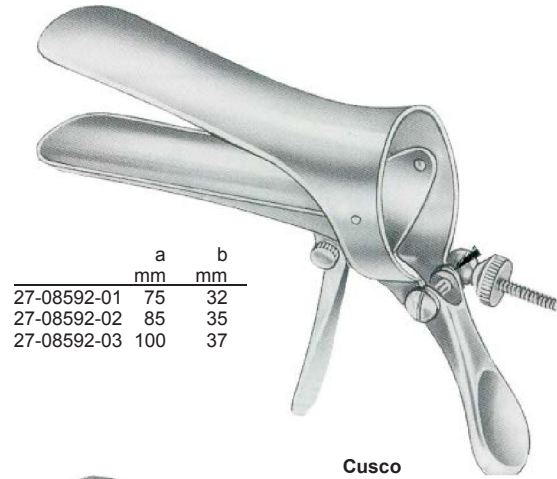
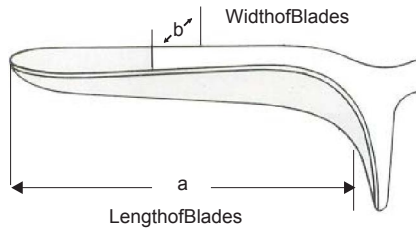

	a mm	b mm
27-08592-01	75	32
27-08592-02	85	35
27-08592-03	100	37

Cusco

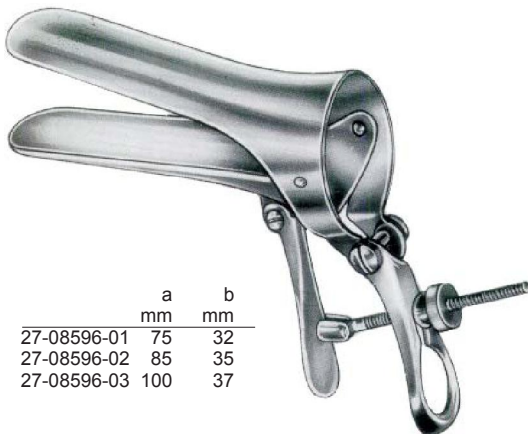

	a mm	b mm
27-08596-01	75	32
27-08596-02	85	35
27-08596-03	100	37

Cusco

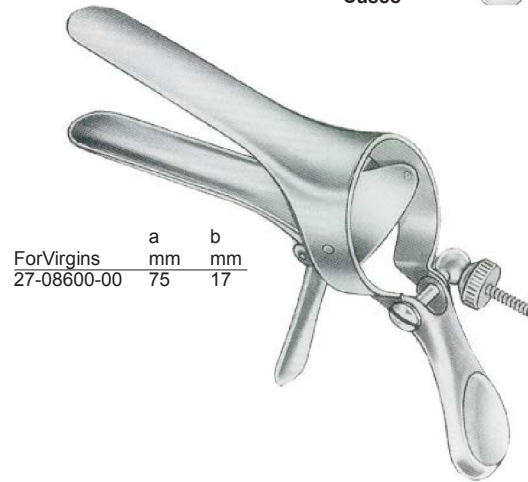

For Virgins	a mm	b mm
27-08600-00	75	17

Cusco

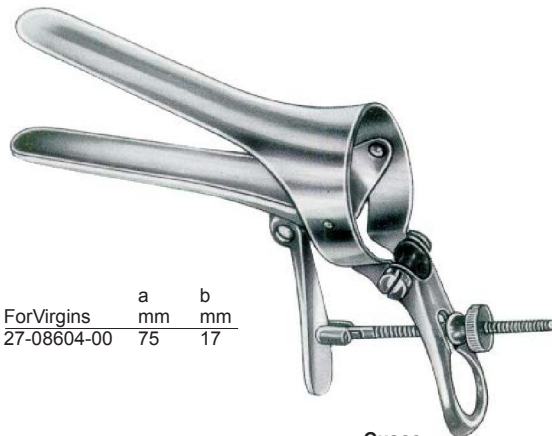

For Virgins	a mm	b mm
27-08604-00	75	17

Cusco



	a mm	b mm
27-08608-01	90	23-25
27-08608-02	100	25-27
27-08608-03	110	27-30

Cusco  
Swiss Pattern



**Collin-Landau**

	a mm	b mm
27-08612-01	85	30
27-08612-02	100	35
27-08612-03	110	40



**Collin**

	a mm	b mm
27-08616-01	85	30
27-08616-02	100	35
27-08616-03	110	40

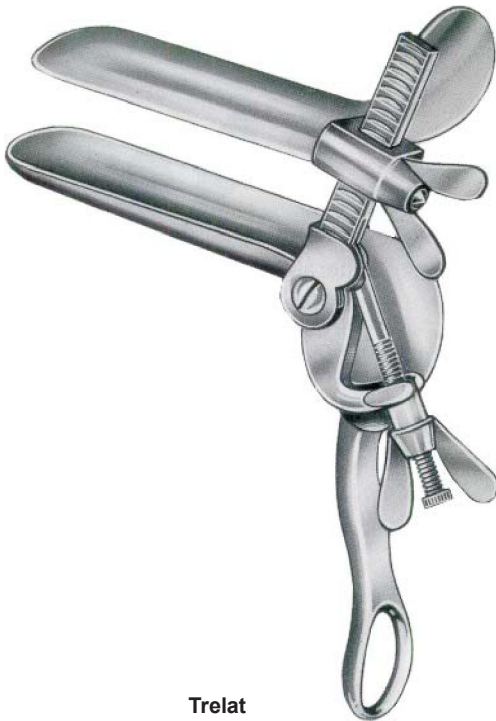

**Trelat**

	a mm	b mm
27-08620-01	85	33
27-08620-02	95	35
27-08620-03	115	43



**Grave(Standard)**

	a mm	b mm
27-08624-01	75	20
27-08624-02	95	30
27-08624-03	115	35
27-08624-04	125	35

**Black**



Grave	a mm	b mm
27-08628-01	75	20
27-08628-02	95	30
27-08628-03	115	35

**Insulated**



Grave	a mm	b mm
Angled135° 27-08632-00	101	35

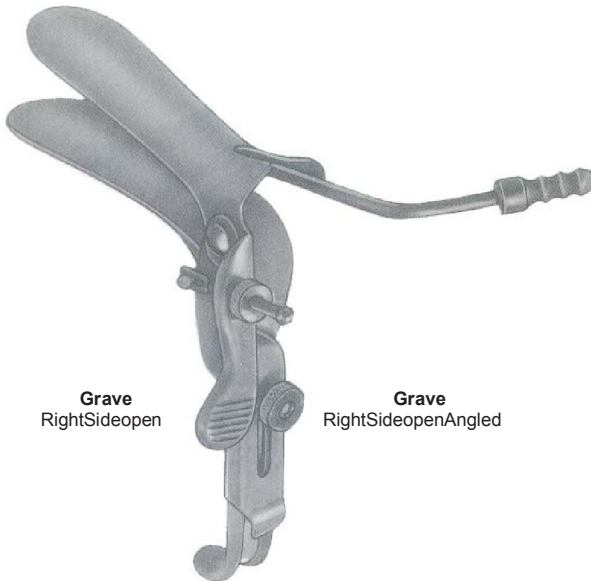

**Grave**  
RightSideopen

**Grave**  
RightSideopenAngled

	a mm	b mm
27-08636-01	101	35
27-08636-02		

**LateralSpecula**

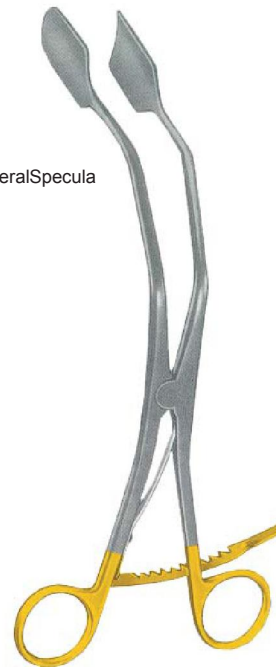

27-08640-00





**Pederson**

	a mm	b mm
27-08644-01	75	13
27-08644-02	100	22
27-08644-03	120	25

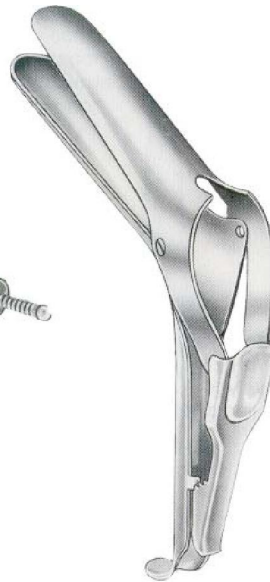

**Semm**

	a mm	b mm
27-08648-01	90	14/18
27-08648-02	100	17/20
27-08648-03	100	25/30

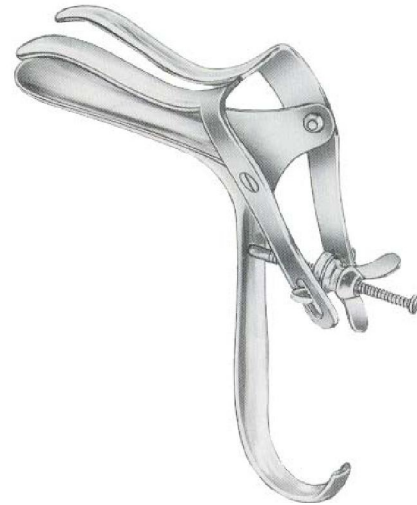

**Nott**

	a mm	b mm
27-08652-01	90	30
27-08652-02	110	30

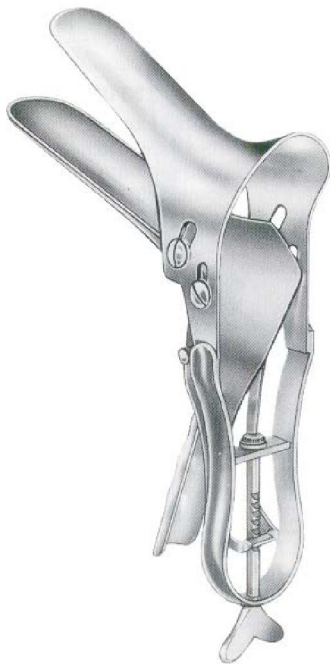

**Seyffert**

	a mm	b mm
27-08656-01	100	17
27-08656-02	110	33

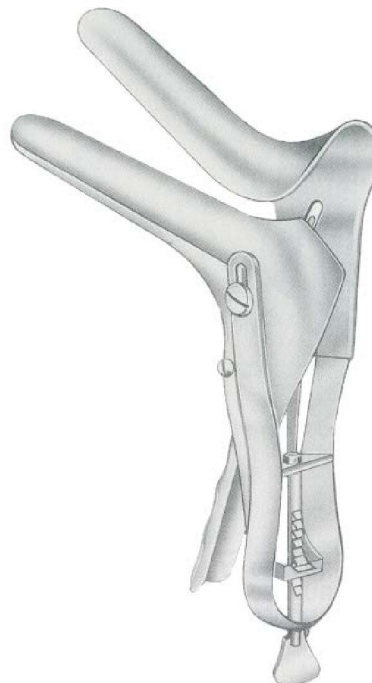

**OneSideopen**

**Seyffert**

	a mm	b mm
27-08658-02	110	33



Scheme of Dimensions for Specula

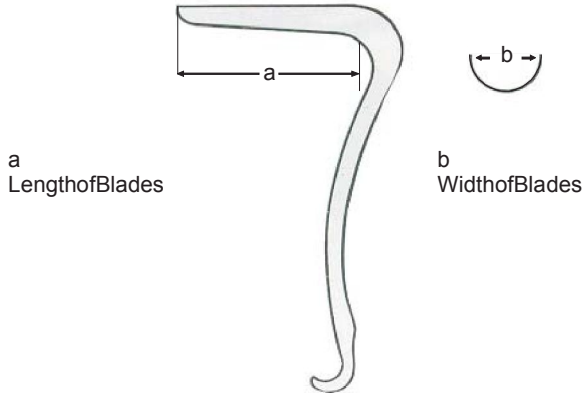

**Sims**  
 27-08662-01 63x32mm  
 27-08662-02 76x32mm  
 27-08662-03 89x38mm



**Sims**

	Fig	a mm	b mm
27-08666-01	1	60	25+30
27-08666-02	2	70	30+35
27-08666-03	3	80	35+40



**Jackson**

	Fig.	a mm	b mm
27-08670-01	1	75X40	
27-08670-02	2	90X40	
27-08670-03	3	100X40	



**Eastman**

	Fig.	a mm	b mm
27-08674-01	1	76	38
27-08674-02	2	89	38
27-08674-03	3	101	38

Forchildren

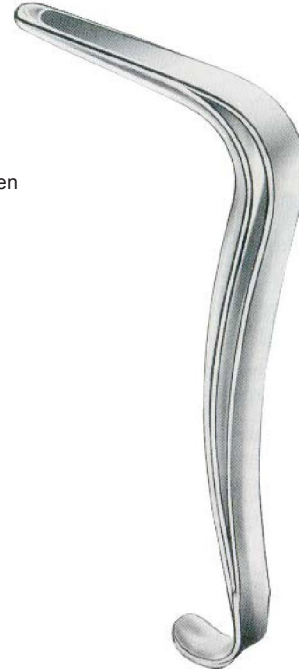

Set

**Kristeller**  
27-08678-00  
70x15mm



**Kristeller**  
(Standard)

Specula

Retractor

Setof1speculaand1retractor

- Fig.1 27-08682-00  
Fig.2 27-08684-00  
Fig.3 27-08686-00

Specula

	Fig.	a mm	b mm
27-08682-01	1	70	27
27-07684-01	2	75	30
27-07686-01	3	90	36

Retractors

	Fig.	a mm	b mm
27-08682-02	1	75	23
27-07684-02	2	80	26
27-07686-02	3	95	32



With conically shaped blades for virgins

Kristeller

Set of 1 specula and 1 retractor

Fig. 00 27-08690-00

Fig. 0 27-08692-00

Specula

	Fig.	a		b	
		mm	mm	mm	mm
27-08690-01	00	110	18		
27-08692-01	0	110	21		

Retractors

	Fig.	a		b	
		mm	mm	mm	mm
27-08690-02	00	115	14		
27-08692-02	0	115	17		



With extra long blades

Kristeller (Standard)

Set of 1 specula and 1 retractor

Fig. 1 27-08696-00

Fig. 2 27-08698-00

Fig. 3 27-08700-00

Specula

	Fig.	a		b	
		mm	mm	mm	mm
27-08696-01	1	110	27		
27-08698-01	2	110	30		
27-08700-01	3	110	36		

Retractors

	Fig.	a		b	
		mm	mm	mm	mm
27-08696-02	1	115	23		
27-08698-02	2	115	26		
27-08700-02	3	115	32		



With flat hollow specula

**Kristeller**

Set of 1 specula and 1 retractor

Fig.1 27-08704-00  
Fig.2 27-08706-00  
Fig.3 27-08708-00

Specula

	Fig.	a	b
		mm	mm
27-08704-01	1	110	27
27-08706-01	2	110	30
27-08708-01	3	110	36

Retractors

	Fig.	a	b
		mm	mm
27-08704-02	1	115	23
27-08706-02	2	115	26
27-08708-02	3	115	32

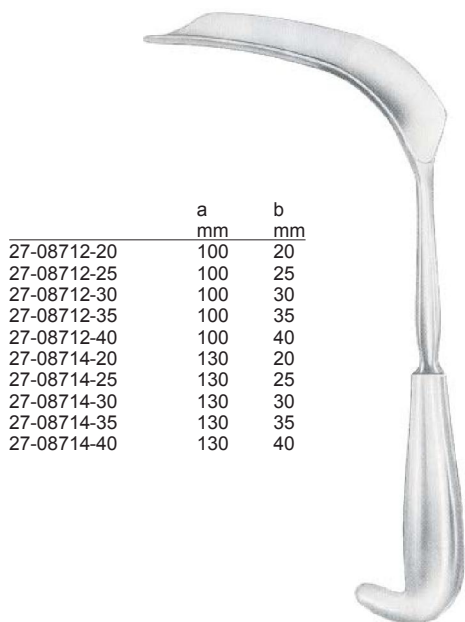

	a	b
	mm	mm
27-08712-20	100	20
27-08712-25	100	25
27-08712-30	100	30
27-08712-35	100	35
27-08712-40	100	40
27-08714-20	130	20
27-08714-25	130	25
27-08714-30	130	30
27-08714-35	130	35
27-08714-40	130	40

**Matzenauer**



**Braun**  
27-08718-18  
18cm/7"  
56x13mm



**Braun**  
27-08722-18  
18cm/7"  
60x10mm



**Ulrich**  
27-08726-19  
19.5cm/7 1/2"  
80x20mm



27-08730-19  
19cm/7 1/2"  
85x17mm



Set

27-08734-00 Fig.1  
27-08736-00 Fig.2

Specula

Fig.	a		b	
	mm	mm	mm	mm
27-08734-01	1	70	40	
27-08736-01	2	90	40	

Retractors

Fig.	a		b	
	mm	mm	mm	mm
27-08734-02	1	70	33	
27-08736-02	2	90	33	

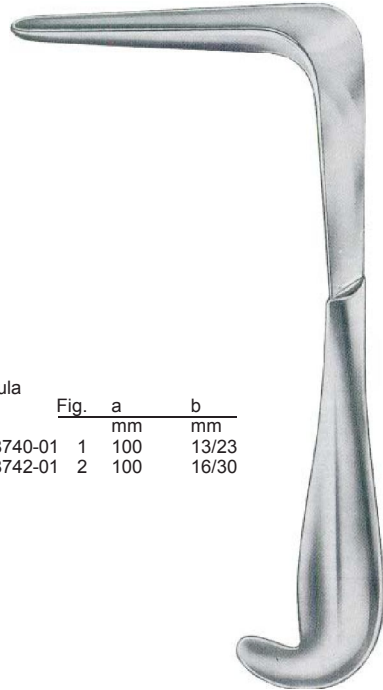

Mathieu

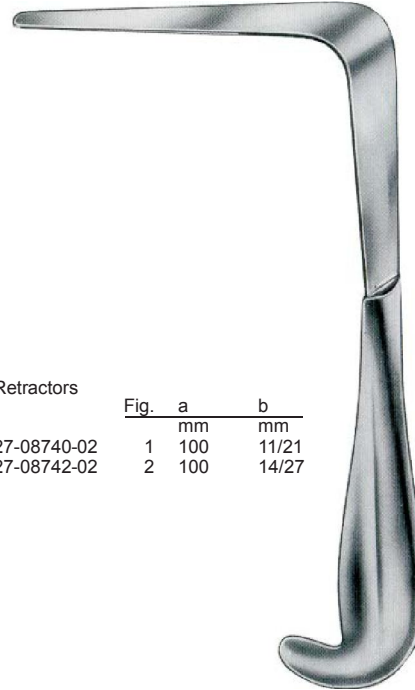

Mathieu

Specula	Fig.	mm	
		a	b
27-08740-01	1	100	13/23
27-08742-01	2	100	16/30

Retractors	Fig.	mm	
		a	b
27-08740-02	1	100	11/21
27-08742-02	2	100	14/27

Set	
Fig.1	27-08740-00
Fig.2	27-08742-00

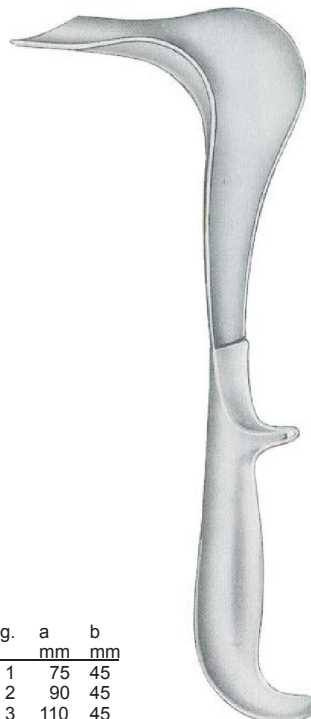

Doyen

Fig.	mm	
	a	b
27-08746-01	75	45
27-08746-02	90	45
27-08746-03	110	45





Doyen 24cm/9 1/2"		Fig.	a mm	b mm	Doyen 24cm/9 1/2"	
slightly-concave	Medium-concave					
27-08750-01	1	55	35	27-08758-01		
27-08750-02	2	85	35	27-08758-02		
27-08750-03	3	115	35	27-08758-03		
27-08752-01	1	55	45	27-08760-01		
27-08752-02	2	85	45	27-08760-02		
27-08752-03	3	115	45	27-08760-03		
27-08752-04	4	160	45			
27-08752-05	5	180	45			
27-08754-01	1	55	60	27-08762-01		
27-08754-02	2	85	60	27-08762-02		
27-08754-03	3	115	60	27-08762-03		
27-08754-04	4	160	60			
27-08754-05	5	180	60			

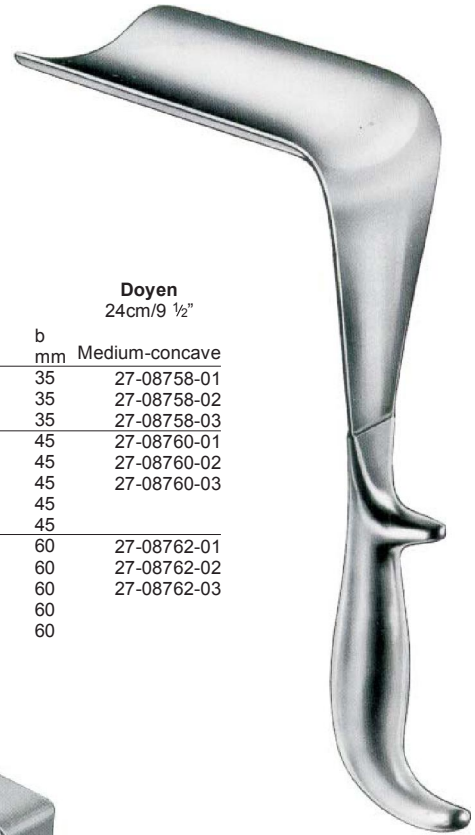

**Doyen**  
25cm/10"

	a mm	b mm
27-08766-01	60	30
27-08766-02	70	30
27-08766-03	80	30



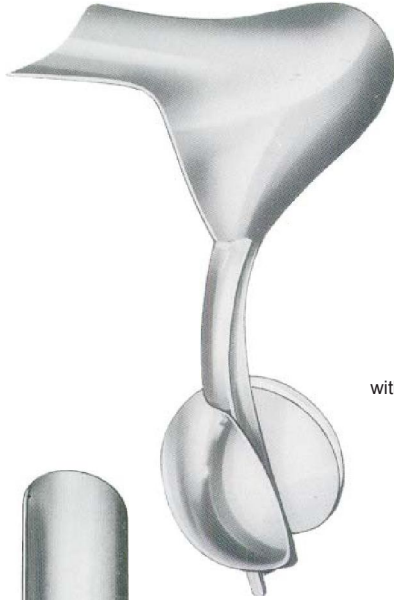

**Auvard**  
with removable weight  
27-08770-01  
80x38mm  
27-08770-02  
105x42mm



**Auvard**  
with fixed weight  
27-08772-01  
70x38mm  
27-08772-02  
102x45mm



**Landau**

	a mm	b mm
27-08776-01	100	28
27-08776-02	100	38



**Breisky**

	a mm	b mm
27-08780-20	100	20
27-08780-25	100	25
27-08780-30	100	30
27-08780-35	100	35
27-08780-40	100	40
27-08782-20	130	20
27-08782-25	130	25
27-08782-30	130	30
27-08782-35	130	35
27-08782-40	130	40
27-08784-20	160	20
27-08784-25	160	25
27-08784-30	160	30
27-08784-35	160	35
27-08784-40	160	40
27-08786-20	180	20
27-08786-25	180	25
27-08786-30	180	30
27-08786-35	180	35
27-08786-40	180	40



**Scherbak**  
27-08790-00

Complete



27-08790-01  
80x30mm



27-08790-02  
85x35mm

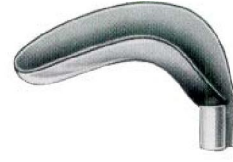

27-08790-03  
90x40mm



27-08790-04  
55x40/60mm



27-08790-05  
70x45/70mm



	Fig.	a mm	b mm
27-08794-01	1	45	17
27-08794-02	2	90	37
27-08794-03	3	90	45



**O'Sullivan-O'Connor**  
27-08794-00  
Complete



Hegar

mmØ		mmØ	
1.0	27-08798-01	1.5	27-08800-01
2.0	27-08798-02	2.5	27-08800-02
3.0	27-08798-03	3.5	27-08800-03
4.0	27-08798-04	4.5	27-08800-04
5.0	27-08798-05	5.5	27-08800-05
6.0	27-08798-06	6.5	27-08800-06
7.0	27-08798-07	7.5	27-08800-07
8.0	27-08798-08	8.5	27-08800-08
9.0	27-08798-09	9.5	27-08800-09
10.0	27-08798-10	10.5	27-08800-10
11.0	27-08798-11	11.5	27-08800-11
12.0	27-08798-12	12.5	27-08800-12
13.0	27-08798-13	13.5	27-08800-13
14.0	27-08798-14	14.5	27-08800-14
15.0	27-08798-15	15.5	27-08800-15
16.0	27-08798-16	16.5	27-08800-16
17.0	27-08798-17	17.5	27-08800-17
18.0	27-08798-18	18.5	27-08800-18
19.0	27-08798-19	19.5	27-08800-19
20.0	27-08798-20		
21.0	27-08798-21		
22.0	27-08798-22		
23.0	27-08798-23		
24.0	27-08798-24		
25.0	27-08798-25		
26.0	27-08798-26		
27.0	27-08798-27		
28.0	27-08798-28		
29.0	27-08798-29		
30.0	27-08798-30		

Piecesperset		set
27-08798-50	14	4.0-17.0mm
27-08798-60	26	1.0-26.0mm



Hegar

Ø mm	
1.0/2.0	27-08804-02
3.0/4.0	27-08804-04
5.0/6.0	27-08804-06
7.0/8.0	27-08804-08
9.0/10.0	27-08804-10
11.0/12.0	27-08804-12
13.0/14.0	27-08804-14
15.0/16.0	27-08804-16
17.0/18.0	27-08804-18
19.0/20.0	27-08804-20
21.0/22.0	27-08804-22
23.0/24.0	27-08804-24
25.0/26.0	27-08804-26

Piecesperset		set
27-08804-00	08	3.0/4.0-17.0/18.0mm
27-08806-00	13	1.0/2.0-25.0/26.0mm



**Hank**  
27-08810-00

Fig.	mm	
9/10	4.5/5	27-08810-10
11/12	5.5/6	27-08810-12
13/14	6.5/7	27-08810-14
15/16	7.5/8	27-08810-16
17/18	8.5/9	27-08810-18
19/20	9.5/10	27-08810-20

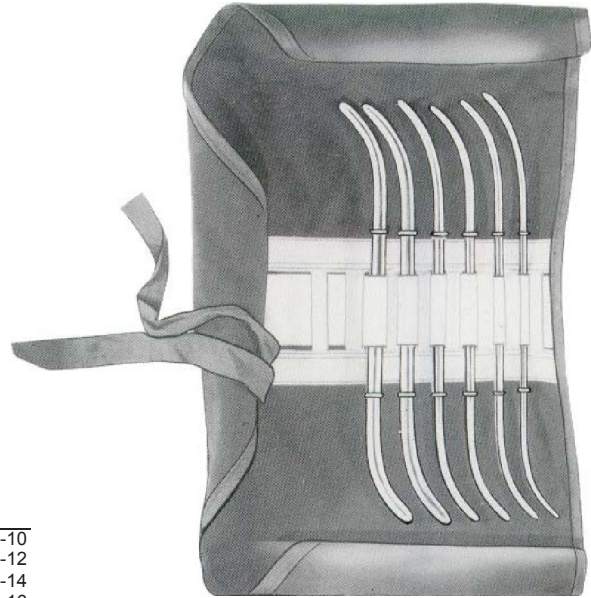

**Set**  
27-08810-00



**Pratt**

Fig.	mm	
13/15	4.5/5.0	27-08816-15
17/19	5.6/6.3	27-08816-19
21/23	7.0/7.6	27-08816-23
25/27	8.3/9.0	27-08816-27
29/31	9.6/10.3	27-08816-31
33/35	11.0/11.6	27-08816-35
37/39	12.3/13.0	27-08816-39
41/43	13.6/14.3	27-08816-43

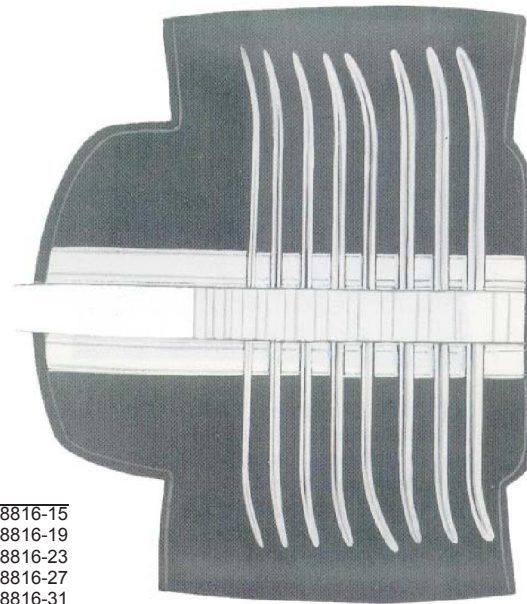

**Set**  
27-08816-00



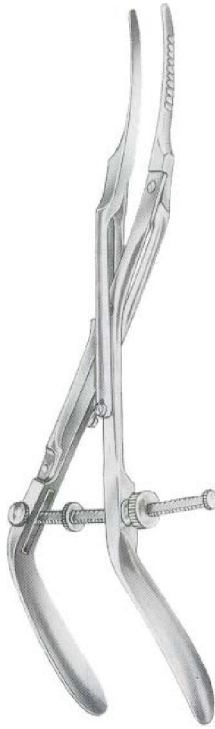

**Goodell**  
 27-08820-34  
 34cm/13 1/2"

BlackInsulated



**Kogan-Laser**  
 28cm/11"



27-08822-28



27-08824-28



27-08826-28  
 28cm/11"



**Kogan**  
 27-08830-24  
 24cm/9 1/2"



**Kogan**  
 27-08832-24  
 24cm/9 1/2"

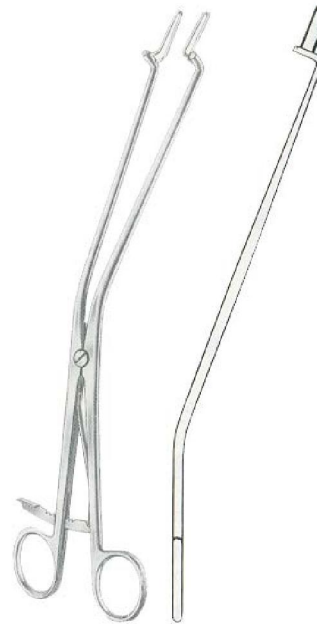

**Kogan**  
 28cm/11"



27-08836-28



27-08838-28



## Uterine Depressor



**Sims**  
32cm/12 ½"



**Martin(Simpson)**  
32cm/12 ½"



**Valleix**  
27-08858-25  
25cm/10"



**Collin**  
27-08862-28  
28cm/11"



**Braun**  
27-08866-28  
28cm/11"

Rigid	cm	cm
	27-08842-32	27-08850-32

Malleable	cm/in	cm/in
	27-08844-32	27-08852-32
	27-08846-32	27-08854-32



## Measuring Instruments

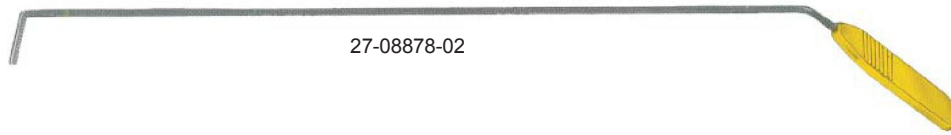
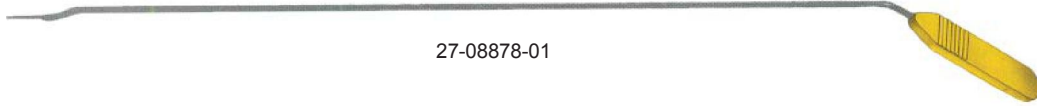

## Hooks



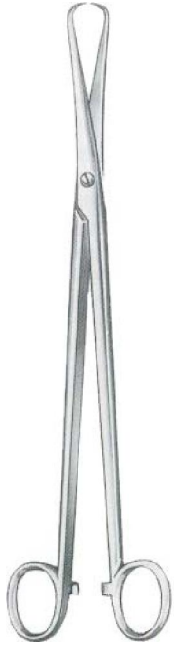

**Martin**  
 27-08886-27  
 27cm/10 1/2"

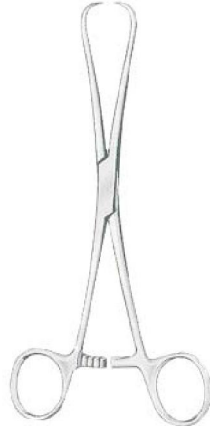

**Staude-Moore**  
 27-08890-17  
 17cm/6 3/4"



**Barrett**  
 27-08894-18  
 18cm/7"



**Schroeder**  
 27-08898-25  
 25cm/10"



**Braun**  
 27-08902-25  
 25cm/10"



**Collin-Pozzi**  
 27-08906-25  
 25cm/10"



**Pozzi**  
 27-08910-25  
 25.5cm/10 1/4"

StrongPattern



**Duplay**  
 27-08914-28  
 28cm/11"



**Skene**  
27-08918-24  
24cm/9 1/2"



AmniotomefortheamniionBladder

**Beacham**  
27-08922-26  
26cm/10 1/4"



**Czerny**  
27-08926-20  
20.5cm/8 1/4"



27-08930-26  
26cm/10 1/4"



**Schroeder**  
27-08934-20 20cm/8"  
27-08934-24 24cm/9 1/2"  
Straight



**Schroeder**  
27-08936-20  
27-08936-24  
Curved on Flat



**Schroeder**  
27-08938-20  
27-08938-24  
Curved Sideway

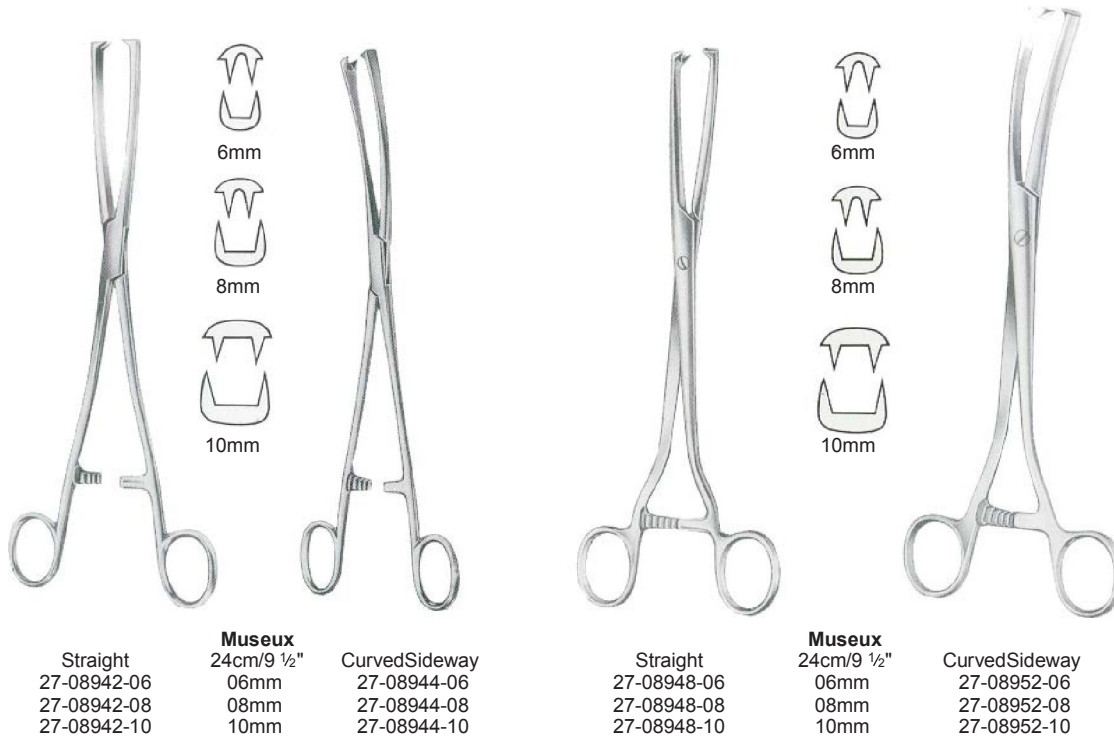





**Teale**  
27-08964-24  
24cm/9 1/2"



**Iowa**  
27-08968-26  
26cm/10 1/4"



**Jacobs**  
Straight 27-08972-21  
CurvedSideway 27-08974-21  
21cm/8 1/4"



**Kelly**  
27-08978-32  
32cm/12 1/2"



**Heywood-Smith**  
27-08982-20  
20cm/8"

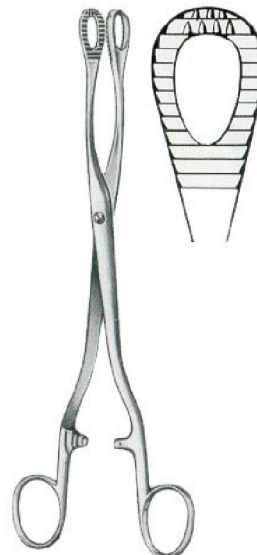

**Heywood-Smith**  
27-08986-25  
25cm/10"



**Noto**  
27-08990-27  
27cm/10 1/2"

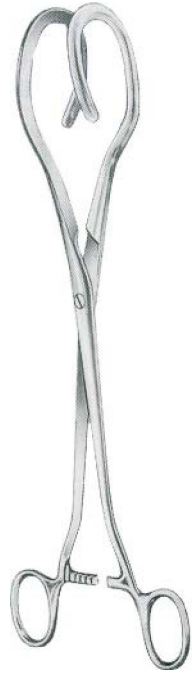

**Dartigues**  
27-08994-27  
27cm/10 ½"



**Somer**  
27-08998-23  
23cm/9"



**Collin**  
27-09002-25  
25cm/10"



**Doyen**  
27-09006-1818cm/7"  
27-09006-2020cm/8"

Ovarian Forceps



**Ayre**  
27-09010-23  
23cm/9"



**Simon**  
27-09014-22  
22cm/8 3/4"



**Simon**  
27-09016-22  
22cm/8 3/4"



**Emmet**  
22cm/8 3/4"



27-09020-01



27-09020-02



27-09020-03



27-09020-04



27-09020-05



**Doyen**  
27-09024-17  
17cm/6 3/4"



**Doyen**  
27-09026-17  
17cm/6 3/4"



**Segond**  
27-09030-27  
27cm/10 1/2"

SecretionSpoon



27-09034-27  
 27cm/10 1/2"



**Muenchen**  
 27cm/10 1/2"



27-09038-04  
 4mm



27-09038-05  
 5mm



**Randall**  
 27-09042-24  
 24cm/9 1/2"

4mmØ



**Novak**  
 23cm/9"

- 27-09046-01  
1mm
- 27-09046-02  
2mm
- 27-09046-03  
3mm
- 27-09046-04  
4mm



**Novak-Schoeckaert**  
 27-09050-24  
 24cm/9"



**Kevorkian**  
 27-09054-30  
 30cm/12"

malleable  
 27-09056-30  
 30cm/12"



**Kevorkian** malleable  
 27-09060-30 27-09062-30  
 30cm/12" 30cm/12"



**Townsend** malleable  
 27-09066-30 27-09068-30  
 31cm/12 1/4" 31cm/12 1/4"



**Duncan**  
 27-09072-31  
 31cm/12 1/4"



**Duncan**  
 27-09074-31  
 31cm/12 1/4"



**Gellhorn**  
 27-09078-23  
 23cm/9"



**Thoms-Gaylor**  
 27-09082-24  
 24cm/9 1/2"



**Schubert**  
 27-09086-21 21cm/8 1/4"  
 27-09086-29 29cm/11 1/4"



**Schubert**  
 27-09090-26  
 26cm/10 1/4"



**Tischler**  
 27-09094-27  
 27cm/10 1/2"



**VanDoren**  
 27-09098-25  
 25cm/10"





Fig.1

Fig.2

**Schumacher**

Fig.1 27-09102-01 24cm/9 1/2"  
 Fig.2 27-09102-02 24cm/9 1/2"



**Faure**

27-09106-21  
 21cm/8 1/4"

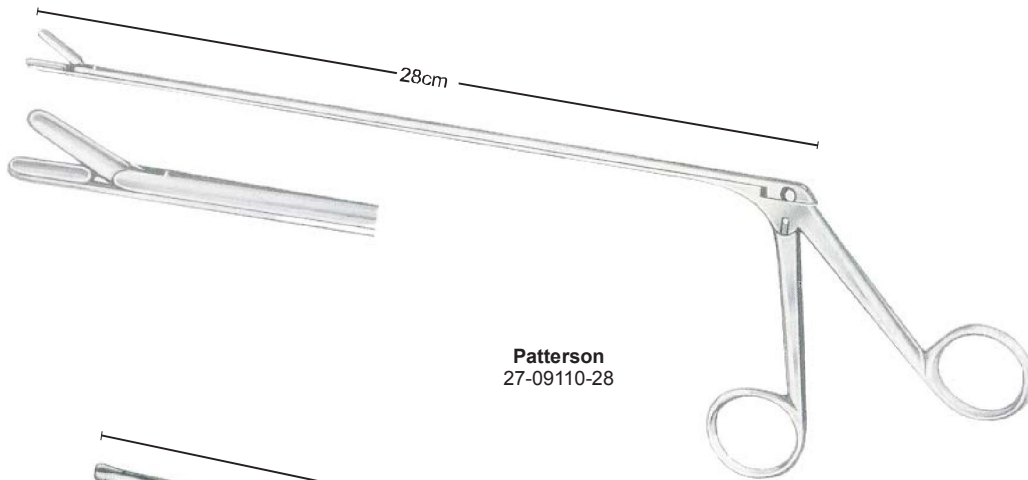

**Patterson**  
 27-09110-28

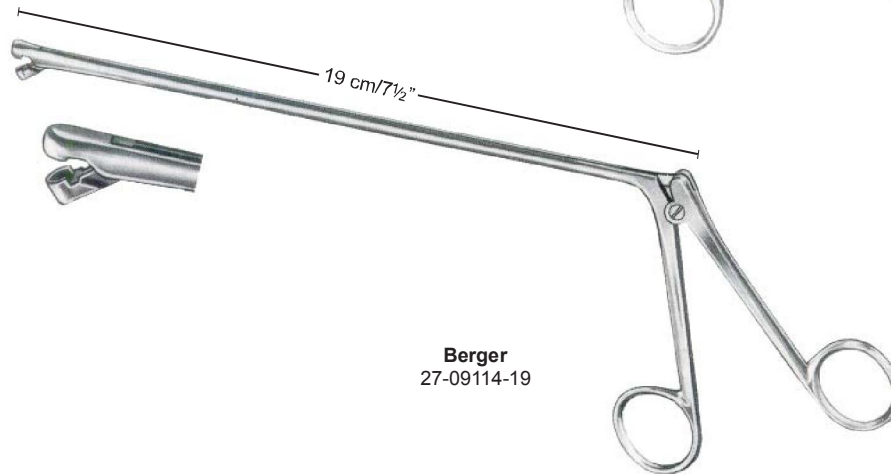

**Berger**  
 27-09114-19



- 27-09118-20 L=20cm/8"
- 27-09118-25 L=25cm/10"
- 27-09118-30 L=30cm/12"
- 27-09118-35 L=35cm/14"
- 27-09118-40 L=40cm/16"



27-09124-04      27-09124-06  
4mm                      6mm



27-09128-24

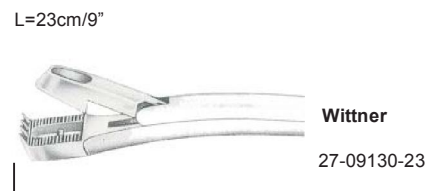

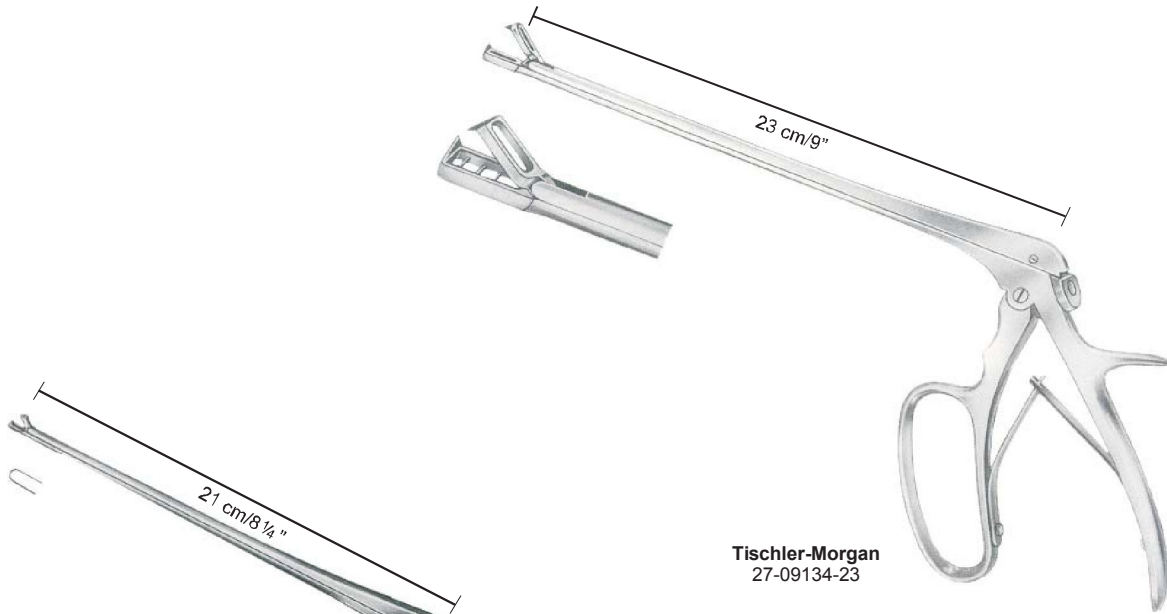

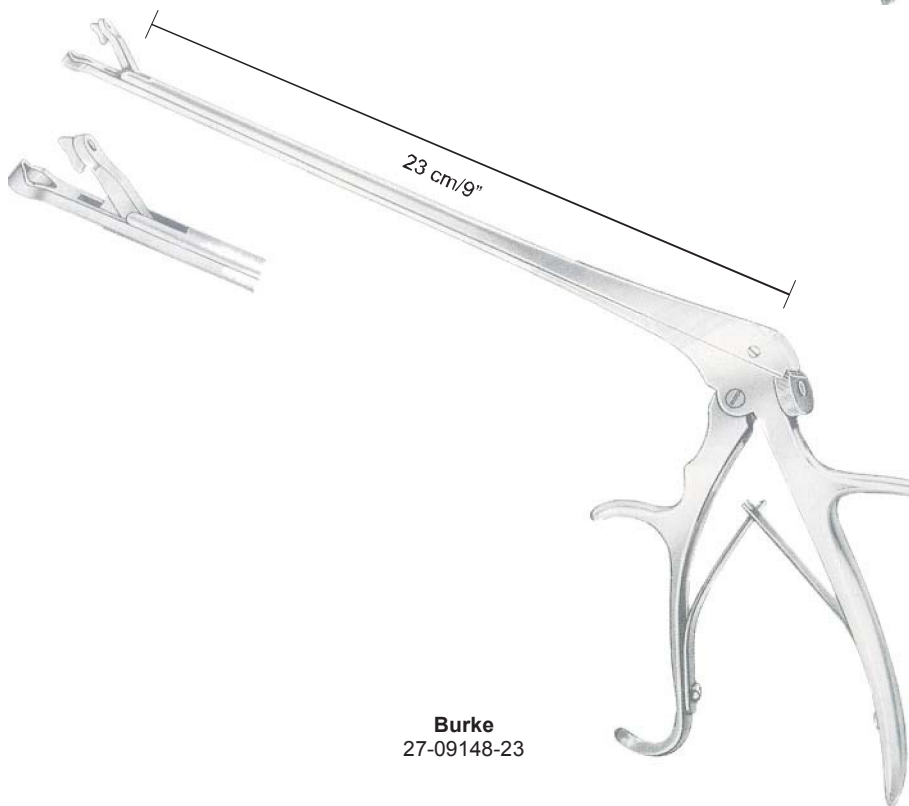











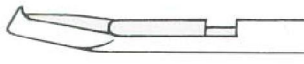

Handle

Townsend

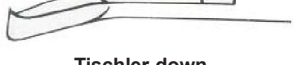

Tipwithtube

		Completeinstrument	Tip,only
	<b>Tischier</b>	27-09152-00	27-09152-01
	<b>Kevorkian</b>	27-09154-00	27-09154-01
	<b>Mini-Townsend</b>	27-09156-00	27-09156-01
	 <b>Tischler-up</b>	27-09158-00	27-09158-01
	 <b>Tischler-down</b>	27-09160-00	27-09160-01
	 <b>Mini-Townsend-up</b>	27-09162-00	27-09162-01
	 <b>Mini-Townsend-down</b>	27-09164-00	27-09164-01



**Schroeder**  
30cm/12"

SharpRigid



Fig.1  
27-09168-01  
27-09170-01



Fig.2  
27-09168-02  
27-09170-02



Fig.3  
27-09168-03  
27-09170-03

Schroeder  
Simon



Fig.4  
27-09168-04  
27-09170-04



Fig.5  
27-09168-05  
27-09170-05



Fig.6  
27-09168-06  
27-09170-06

Schroeder  
Simon



**Simon**  
25cm/10"



**Gourdet**  
28cm/11"



Fig.1  
27-09174-01  
6mm



Fig.2  
27-09174-02  
8mm



Fig.3  
27-09174-03  
10mm



Fig.4  
27-09174-04  
12mm



Fig.5  
27-09174-05  
14mm





**Thomas**



Fig.1  
27-09177-01



Fig.2  
27-09177-02



Fig.3  
27-09177-03



Fig.4  
27-09177-04



Fig.5  
27-09177-05



Fig.6  
27-09177-06



**Greene**

27-09180-10  
10mm

27-09180-12  
12mm

27-09180-14  
14mm



**Collin**  
27-09184-30  
30cm/12"



**Heaney**  
27-09188-24  
24cm/9 1/2"



**Heaney**  
27-09192-24  
24cm/9 1/2"



**Milan**  
28.5cm/11 1/4"

Malleable

27-09196-05  
5mmO/

27-09196-07  
7mmO/

27-09196-09  
9mmO/

Rigid

27-09198-05  
5mmO/

27-09198-07  
7mmO/

27-09198-09  
9mmO/



28cm/11"

HoseConnectingPiece



27-09206-00

- |             |        |
|-------------|--------|
|             | Ø      |
| 27-09202-04 | 4.0mm  |
| 27-09202-06 | 6.0mm  |
| 27-09202-08 | 8.0mm  |
| 27-09202-10 | 10.0mm |
| 27-09202-12 | 12.0mm |
| 27-09202-14 | 14.0mm |
| 27-09202-16 | 16.0mm |



**Sims**  
25cm/10"

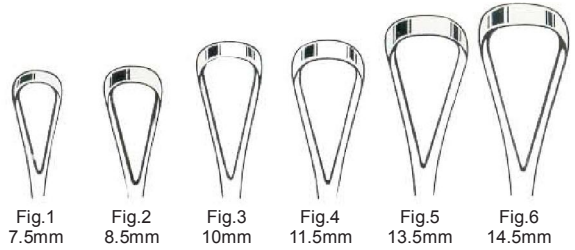

Malleable		Rigid	
Sharp	Blunt	Sharp	Blunt

Fig.1	27-09210-01	27-09211-01	27-09214-01	27-09215-01
Fig.2	27-09210-02	27-09211-02	27-09214-02	27-09215-02
Fig.3	27-09210-03	27-09211-03	27-09214-03	27-09215-03
Fig.4	27-09210-04	27-09211-04	27-09214-04	27-09215-04
Fig.5	27-09210-05	27-09211-05	27-09214-05	27-09215-05
Fig.6	27-09210-06	27-09211-06	27-09214-06	27-09215-06



**Sims**  
25cm/10"

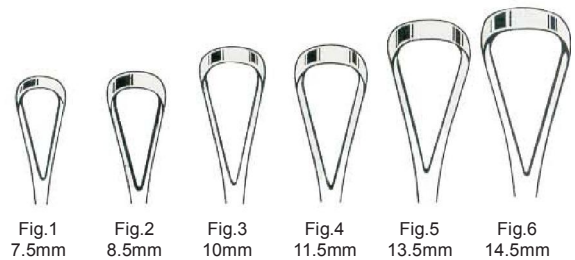

Malleable		Rigid	
Sharp	Blunt	Sharp	Blunt

Fig.1	27-09218-01	27-09219-01	27-09222-01	27-09223-01
Fig.2	27-09218-02	27-09219-02	27-09222-02	27-09223-02
Fig.3	27-09218-03	27-09219-03	27-09222-03	27-09223-03
Fig.4	27-09218-04	27-09219-04	27-09222-04	27-09223-04
Fig.5	27-09218-05	27-09219-05	27-09222-05	27-09223-05
Fig.6	27-09218-06	27-09219-06	27-09222-06	27-09223-06



26cm



Rigid

Malleable



31cm

Recamier

Fig.	mm	Malleable		Rigid		Malleable		Rigid	
		Sharp	Blunt	Sharp	Blunt	Sharp	Blunt	Sharp	Blunt
00	5	27-09226-05	27-09227-05	27-09228-05	27-09229-05	27-09230-05	27-09231-05	27-09232-05	27-09233-05
0	6	27-09226-06	27-09227-06	27-09228-06	27-09229-06	27-09230-06	27-09231-06	27-09232-06	27-09233-06
1	7	27-09226-07	27-09227-07	27-09228-07	27-09229-07	27-09230-07	27-09231-07	27-09232-07	27-09233-07
2	8	27-09226-08	27-09227-08	27-09228-08	27-09229-08	27-09230-08	27-09231-08	27-09232-08	27-09233-08
3	9	27-09226-09	27-09227-09	27-09228-09	27-09229-09	27-09230-09	27-09231-09	27-09232-09	27-09233-09
4	10	27-09226-11	27-09227-11	27-09228-11	27-09229-11	27-09230-11	27-09231-11	27-09232-11	27-09233-11
5	12	27-09226-12	27-09227-12	27-09228-12	27-09229-12	27-09230-12	27-09231-12	27-09232-12	27-09233-12
6	14	27-09226-14	27-09227-14	27-09228-14	27-09229-14	27-09230-14	27-09231-14	27-09232-14	27-09233-14
7	15	27-09226-15	27-09227-15	27-09228-15	27-09229-15	27-09230-15	27-09231-15	27-09232-15	27-09233-15
8	16	27-09226-16	27-09227-16	27-09228-16	27-09229-16	27-09230-16	27-09231-16	27-09232-16	27-09233-16
9	19	27-09226-19	27-09227-19	27-09228-19	27-09229-19	27-09230-19	27-09231-19	27-09232-19	27-09233-19
10	20	27-09226-20	27-09227-20	27-09228-20	27-09229-20	27-09230-20	27-09231-20	27-09232-20	27-09233-20
11	21	27-09226-21	27-09227-21	27-09228-21	27-09229-21	27-09230-21	27-09231-21	27-09232-21	27-09233-21
12	23	27-09226-23	27-09227-23	27-09228-23	27-09229-23	27-09230-23	27-09231-23	27-09232-23	27-09233-23
13	25					27-09230-25	27-09231-25	27-09232-25	27-09233-25
14	30					27-09230-30	27-09231-30	27-09232-30	27-09233-30
15	35					27-09230-35	27-09231-35	27-09232-35	27-09233-35
16	40					27-09230-40	27-09231-40	27-09232-40	27-09233-40



**Bumm**  
 max.29cm/11 1/2"

Fig.	mm	Mealleable	
		Sharp	Blunt
0	16.0	27-09236-16	27-09237-16
1	18.0	27-09236-18	27-09237-18
2	19.5	27-09236-19	27-09237-19
3	21.5	27-09236-21	27-09237-21
4	23.5	27-09236-23	27-09237-23
5	26.0	27-09236-26	27-09237-26
6	28.5	27-09236-28	27-09237-28



Blunt

Sharp

**Blake(Zweifel)**  
 27-09240-2727cm/10 1/2"  
 27-09240-3131cm/12 1/4"

For Internal Measurements



28-09244-45  
Laparotomy Ring  
1 3/4" Inside Diameter



**DeLee**  
28-09248-20  
20cm/8"  
cm/Inch Scale



**Martin**  
28-09252-34 34cm/13 1/2" 28-09254-34  
cm/Inch Scale



**Collin**  
28-09258-35  
35cm/13 3/4"  
cm Scale



**Breisky**  
28-09262-33  
33cm/13"  
cm/Inch Scale



**Collyer**  
28-09266-30  
30cm/12"  
cm/Inch Scale



**Iowa**  
28-09270-14  
14cm/5 1/2"  
Trumpet Needle Guide





**Winter**  
28cm/11"

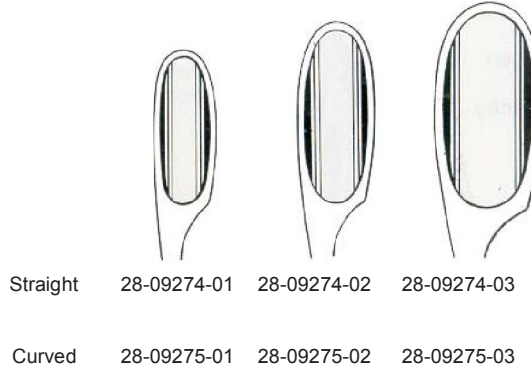

**Wallich**  
28-09278-42  
42cm/16 3/4"

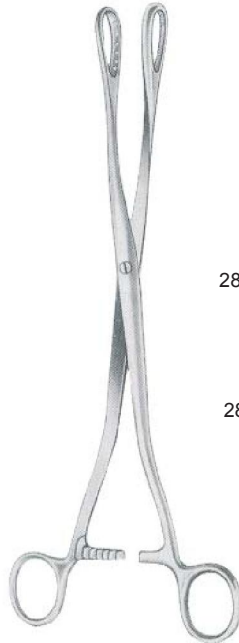

**Sanger**  
27cm/10 1/2"

Straight  
28-09282-27

Curved  
28-09283-27

Uterine Haemostasis Forceps



**Green-Armytage**  
28-09286-21  
21cm/8 1/4"

ScalpFlapForceps



**Gauss**  
 28-09290-26  
 26cm/10 1/4"



**Willet-Martel**  
 28-09294-19  
 19cm/7 1/2"

HeadLever



**Murless**  
 28-09298-26  
 26cm/10 1/4"

ElevatingSpoon



**Sellheim**  
 28-09302-28  
 28cm/11"



**Smellie**  
 28-09306-25  
 25cm/10"

Perforators



**Nagele**  
 28-09310-25  
 25cm/10"

Cranioclast



**Braun**  
28-09314-42  
42cm/16 1/2"

Basiotribe

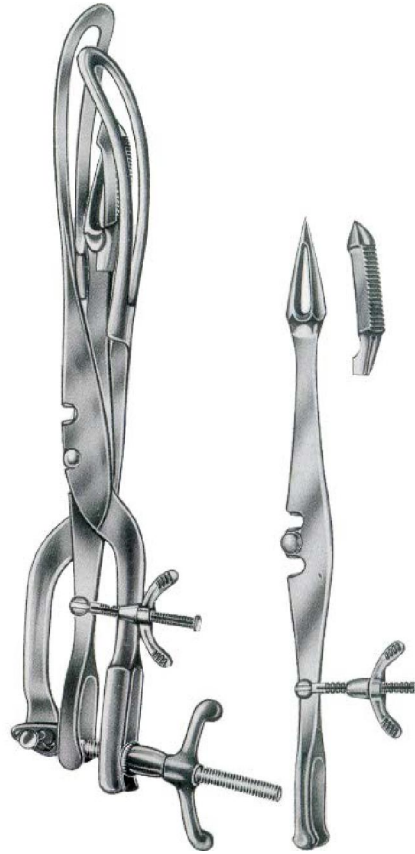

**Tarnier**  
28-09318-46  
46cm/18"

Decapitating Hook



**Braun**  
28-09322-30  
30cm/12"

Umbilical Cord Clamps



**Collin**  
28-09326-09  
9cm/3 1/2"



**Nagele**  
 28-09330-3636cm/14"  
 28-09330-4040cm/16"



**Wrigley**  
 28-09334-28  
 28cm/11"



**Simpson**  
 28-09338-23  
 23cm/9"



**Simpson**  
 28-09340-30  
 30cm/12"



**Simpson-Braun**  
 28-09342-36  
 36cm/14"



**Simpson-Luikart**  
 28-09344-36  
 36cm/14"



**DeLee**  
 28-09348-3030cm/12"  
 28-09348-3636cm/14"

Traction Handle to be used with all obstetrical Forceps with Standard type Handles



**Bill**  
 28-09350-20



**Kielland**  
 28-09352-41  
 41cm/16"



**Kielland-Luikart**  
 28-09354-40  
 40cm/15 3/4"



**Mclean**  
 28-09358-36  
 36cm/14"



**Elliot**  
 28-09362-3232cm/12 1/2"  
 28-09362-3838cm/15"



**Piper**  
 28-09366-44  
 44cm/17 1/4"



With Traction Handle

**Barnes-Neville**  
 28-09370-43  
 43.5cm/17"



With Traction Handle

**Tarnier**  
 28-09374-40  
 40cm/15 3/4"



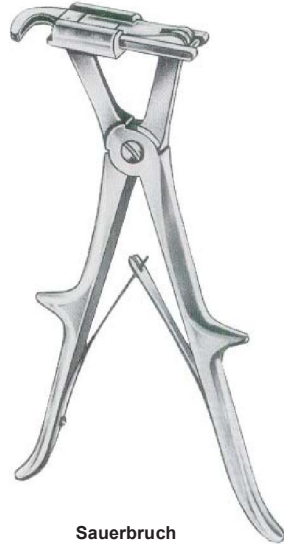

**Sauerbruch**  
29-09378-2424cm/9 1/2"  
29-09378-2626cm/10 1/4"



**Giertz-Stillle**  
29-09382-27  
27cm/10 1/2"

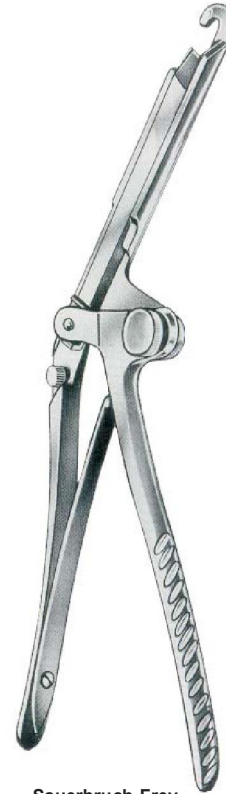

**Sauerbruch-Frey**  
29-09386-36  
36cm/14"



**Bethune**  
29-09390-34  
34cm/13 1/2"

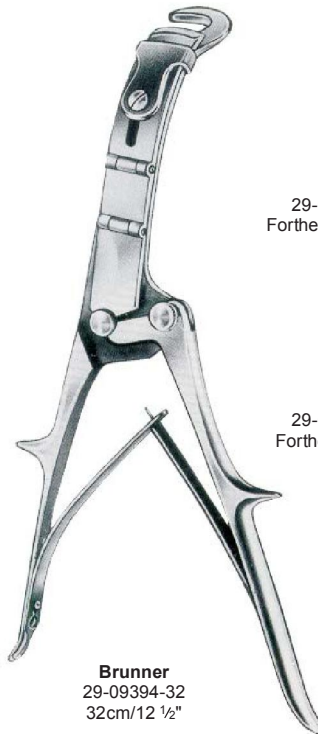

**Brunner**  
29-09394-32  
32cm/12 1/2"

29-09394-32  
For the Right Hand

29-09395-32  
For the Left Hand



**Lebsche**  
29-09398-24  
24.5cm/9 3/4"

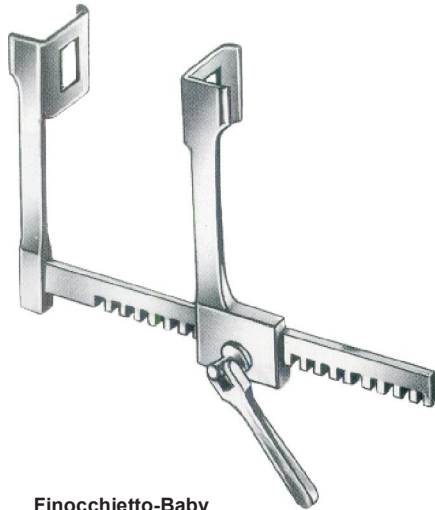

**Finocchietto-Baby**

	a	b	c
29-09402-00	18mm	21mm	105mm

Scheme of Dimensions

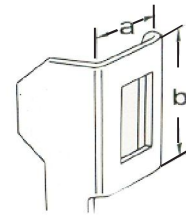

Size of Blades

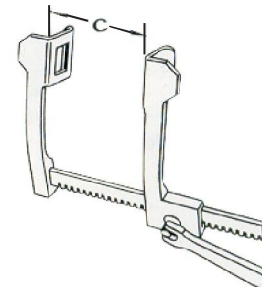

Total Spread



**Finocchietto**

	a	b	c
29-09406-01	36mm	45mm	165mm
29-09406-02	44mm	65mm	200mm
29-09406-03	44mm	65mm	250mm
29-09406-04	44mm	65mm	300mm
29-09406-05	65mm	65mm	200mm
29-09406-06	65mm	65mm	250mm
29-09406-07	65mm	65mm	300mm

With 2 Pairs of Interchangeable Blades

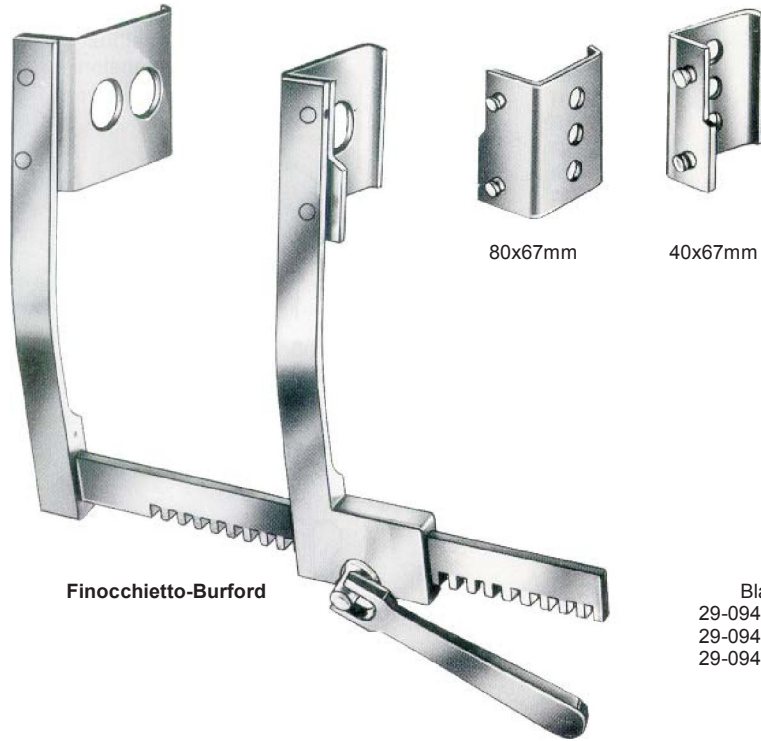

**Finocchetto-Burford**

Blade Opening  
 29-09410-01200mm/8"  
 29-09410-02250mm/10"  
 29-09410-03305mm/12"



**Tuffier**



**Haight**

	a	b	c
29-09418-00	30mm	30mm	115mm

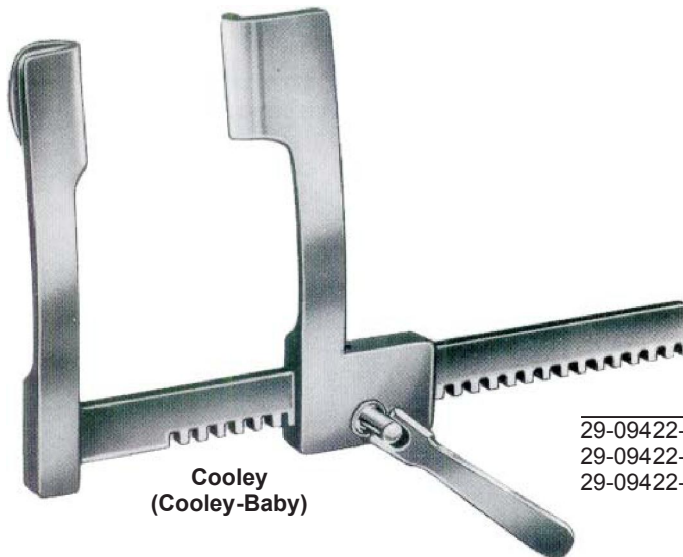

**Cooley  
(Cooley-Baby)**

	a	b	c
29-09422-01	15mm	30mm	75mm
29-09422-02	21mm	45mm	145mm
29-09422-03	32mm	50mm	190mm

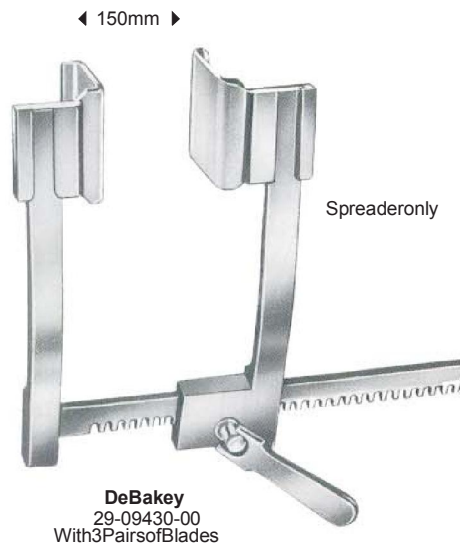
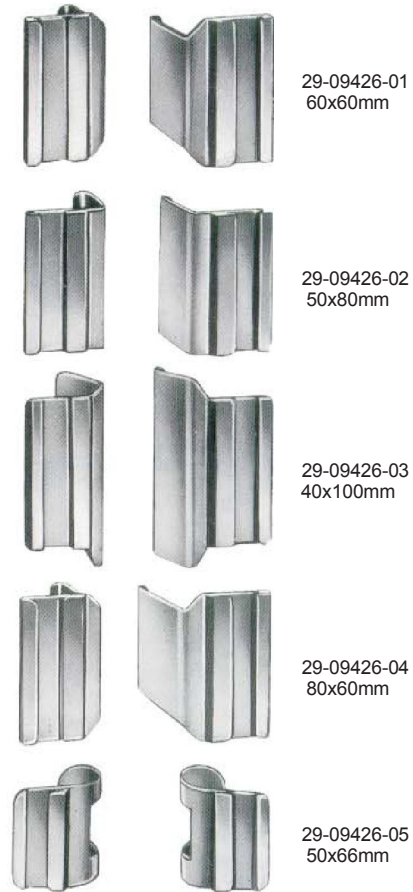
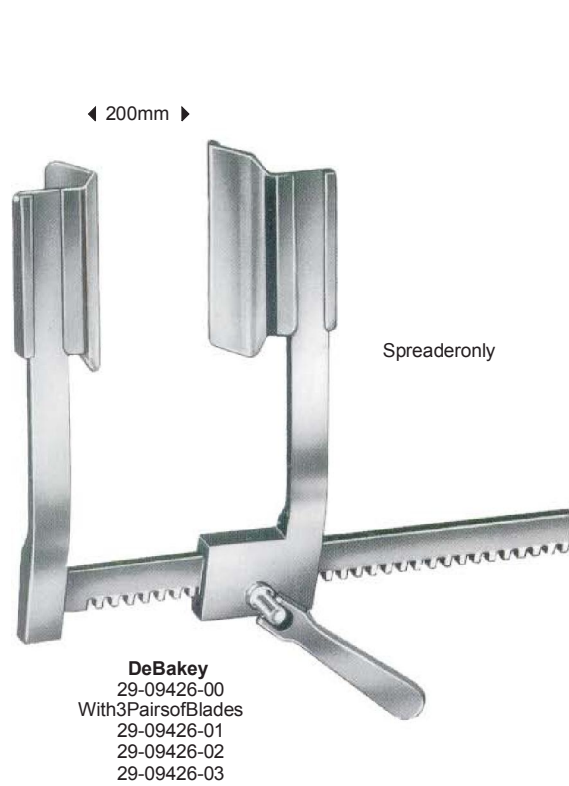

◀ Fig.115cm/6" ▶  
◀ Fig.220cm/8" ▶



**Morse-Favaloro**  
Fig.129-09434-01  
Fig.229-09434-02

75x75mm

42x65mm

Thoracic Retractor



**(Mercedes-Retractor)**  
29-09436-00  
Complete





	a	b	c
29-09438-01	12mm	17mm	75mm
29-09438-02	16mm	30mm	105mm
29-09438-03	37mm	49mm	200mm

**Cooley  
(Cooley-Baby)**



	a	b	c
29-09442-01	10.5mm	32mm	65mm
29-09442-02	12mm	45mm	70mm
29-09442-03	15mm	60mm	120mm

**Castaneda**



	a	b	c
29-09446-01	15mm	15mm	75mm
29-09446-02	31mm	31mm	100mm

**Finocchietto-Baby-Haight**



**Finocchetto**

	a	b	c
29-09450-01	38mm	44mm	135mm
29-09450-02	52mm	62mm	135mm
29-09450-03	85mm	65mm	135mm



**Burford**  
With 2 Pairs of Blades

ForChild	a	b	c
	48mm	42mm	135mm
29-09454-00	34mm	42mm	135mm
29-09454-01	65mm	62mm	180mm
	47mm	62mm	
29-09454-02	65mm	62mm	260mm
	47mm	62mm	
29-09454-03	65mm	62mm	300mm
	47mm	62mm	



**Lemmon**  
29-09458-18  
18cm/7"



**Sellors**  
29-09462-19  
19cm/7 1/2"



**Bailey-Baby**  
29-09466-14  
14cm/5 1/2"



**Bailey**  
29-09470-16  
16cm/6 1/4"



**Bailey-Gibbon**  
29-09474-16  
16cm/6 1/4"



**Allison**  
29-09478-2525.5cm/10"  
29-09478-3030.0cm/12"

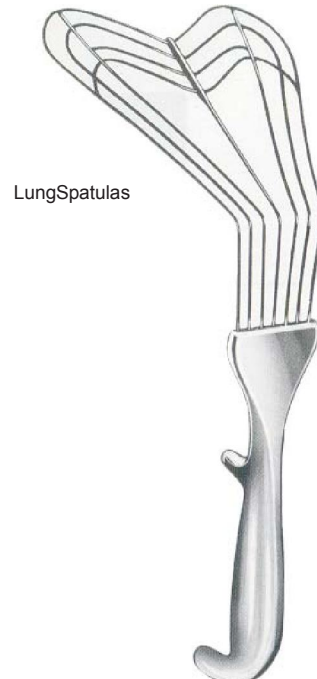

Lung Spatulas

29-09482-30  
30cm/12"



**Price-Thomas**  
29-09486-22  
22cm/8 3/4"

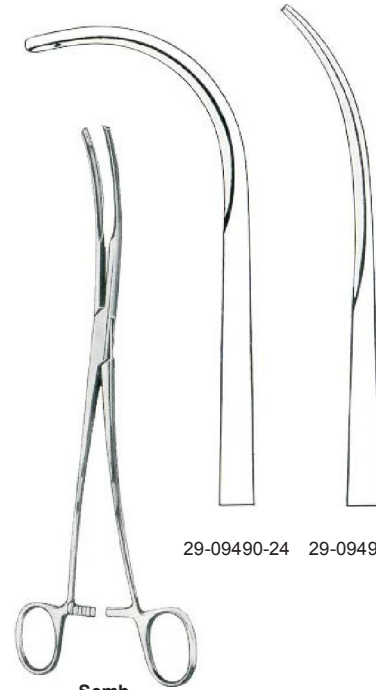

**Semb**  
24cm/9 1/2"

29-09490-24 29-09492-24

Lunggraspingforceps



**Lovelace**  
29-09496-20  
20cm/8"



**Lovelace**  
29-09500-20  
20cm/8"



Fig.1

Fig.2



29-09504-01  
29-09504-02

**Satinsky**  
26.5cm/10 1/2"  
Fig.1  
Fig.2



29-09508-01  
29-09508-02

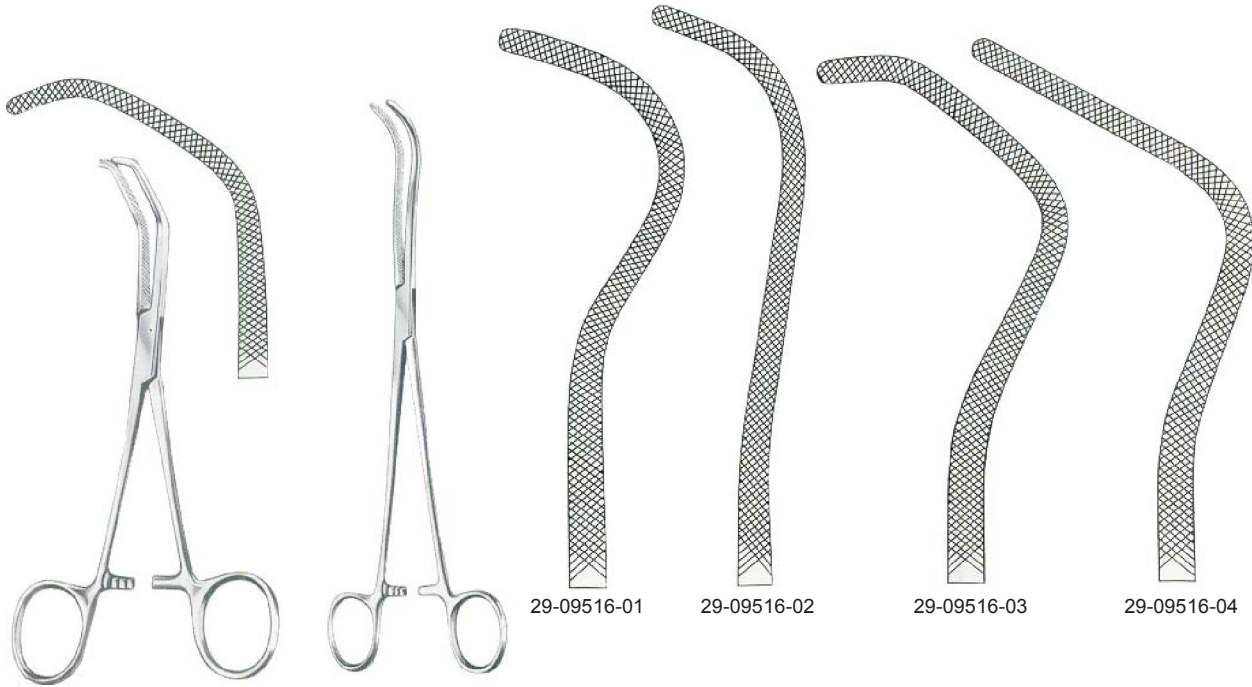

**Baby-Satinsky**  
29-09512-15  
15cm/6"

**Harken**  
24cm/9 1/2"

29-09516-01

29-09516-02

29-09516-03

29-09516-04

### *PinsmedAtraumaTC*

Alraumatissueforceps



**DeBakey**

Wide

29-09520-15	15.0cm/6"	1.5mm
29-09520-19	19.5cm/7 1/2"	1.5mm
29-09520-24	24.0cm/9 1/2"	1.5mm



**DeBakey**

1.2mm	2.0mm	Wide
29-09524-18	29-09526-18	18cm/7"
29-09524-21	29-09526-21	21cm/8 ¼"

## PinsmedAtrauma



**Cooley**

29-09530-15	15.0cm/6"
29-09530-19	19.5cm/7 ½"
29-09530-24	24.0cm/9 ½"



**Wide**

	1.5mm	2.0mm	2.7mm	3.5mm
16cm/6 ¼"	29-09534-16	29-09536-16	29-09538-16	29-09540-16
20cm/8"	29-09534-20	29-09536-20	29-09538-20	29-09540-20
24cm/9 ½"	29-09534-24	29-09536-24	29-09538-24	29-09540-24
30cm/12"	29-09534-30	29-09536-30	29-09538-30	29-09540-30

**DeBakey**



**Wide  
2.0mm**

29-09543-16
29-09543-20
29-09543-24
29-09543-30

**DeBakey**





DeBakey

Setting forceps



29-09546-23  
23cm/9"



29-09550-07	7.5cm/3"	29-09551-07
29-09550-08	8.5cm/3 1/2"	29-09551-08
29-09550-10	10.5cm/4 1/4"	29-09551-10
29-09550-12	12.0cm/4 3/4"	29-09551-12



29-09554-03  
3.5cm/1 1/2"



29-09555-03  
3.5cm/1 1/2"



29-09558-04  
4.5cm/1 3/4"



29-09559-04  
4.5cm/1 3/4"

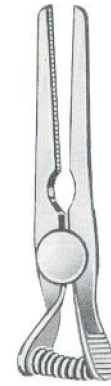

De-Bakey  
29-09562-05  
5.0cm/2"



De-Bakey  
29-09563-05  
5.0cm/2"



DeBakey



**Glover**

29-09566-06	6cm/2 1/2"
29-09566-07	7cm/2 3/4"
29-09566-09	9cm/3 1/2"
29-09566-11	11cm/4 1/2"



**Glover**

29-09567-06	
29-09567-07	
29-09567-09	
29-09567-11	



**Glover**

29-09571-06  
5cm/2"



**DeBakey-Satinsky**

29-09575-07  
7cm/2 3/4"



DeBakey



**DeBakey-Carotid**  
29-09579-09  
9cm/3 1/2"



**DeBakey-Satinsky**  
29-09583-10  
10cm/4"



**Santulli**  
29-09587-07  
7cm/2 3/4"



**Gregory-Soft**  
29-09591-09 29-09593-11  
9cm/3 1/2" 11cm/4 1/2"



DeBakey

CoarctationClamps



**Potts  
(DeBakey)**



29-09596-21  
21cm/8 1/4"



29-09596-22  
22cm/8 3/4"



**Potts  
(DeBakey)**



29-09599-21  
21cm/8 1/4"



29-09599-22  
22cm/8 3/4"



**Potts**



29-09601-21  
21cm/8 1/4"



29-09601-22  
22cm/8 3/4"

Anastomosis Clamps



**Glover  
(Potts)**



**DeBakey**



29-09605-21  
21cm/8 1/4"



29-09605-22  
22cm/8 1/4"

Dissecting and  
Ligature Forceps



**DeBakey**

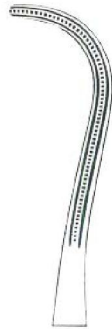

29-09609-20  
20cm/8"



29-09609-24  
24cm/9 1/2"



**DeBakey**



29-09613-20  
20cm/8"



29-09615-18  
18cm/7 1/2"



DeBakey



Leland-Jones



29-09618-01  
19.5cm/7 1/2"



29-09618-02  
19.5cm/7 1/2"

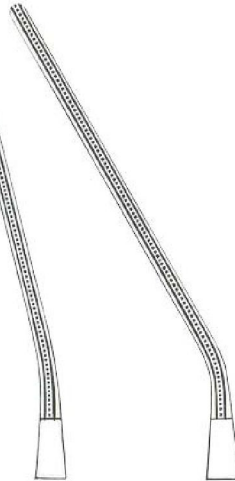

29-09618-03  
19.5cm/7 1/2"



Leland-Jones  
29-09621-18  
18cm/7"



DeBakey-Bainbirdge



29-09624-15  
15cm/6"



29-09624-18  
18cm/7"



29-09625-15  
15cm/6"



29-09625-18  
18cm/7"



DeBakey  
29-09629-20  
20cm/8"





DeBakey

Aortic Aneurysm Clamps





DeBakey

Aortic Aneurysm Clamps



**DeBakey**  
29-09637-28  
28cm/11"



29-09641-30  
30cm/12"



DeBakey

AorticClamps



**Ochsner**  
29-09645-23  
23.5cm/9 1/4"



**Dietrich**  
29-09649-21  
21cm/8 1/4"



DeBakey



29-09653-01  
24cm/9 1/2"



29-09653-02  
24cm/9 1/2"

AuricleClamp



Harken



29-09653-03  
24cm/9 1/2"



29-09653-04  
24cm/9 1/2"



DeBakey

BronchusClamps

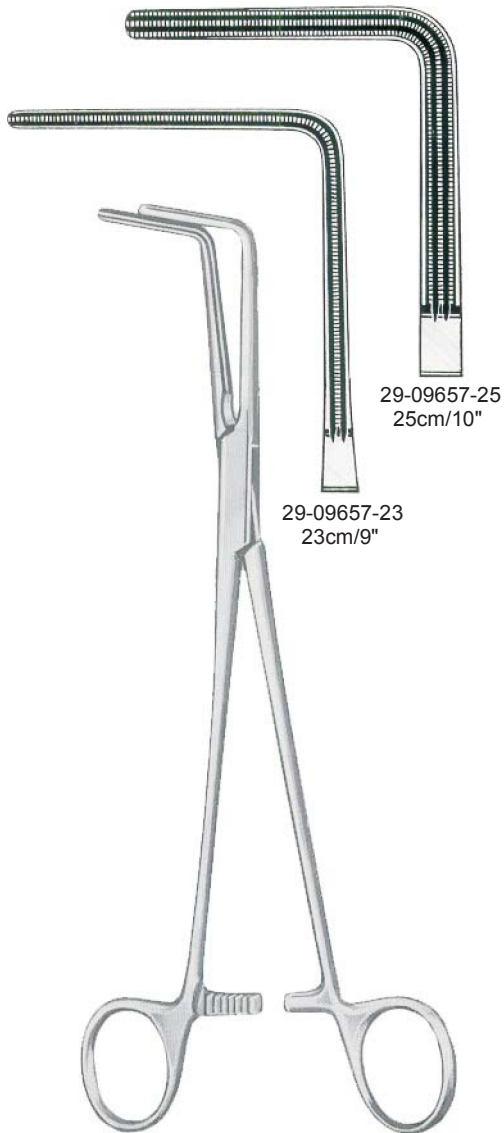



DeBakey

AorticClamp

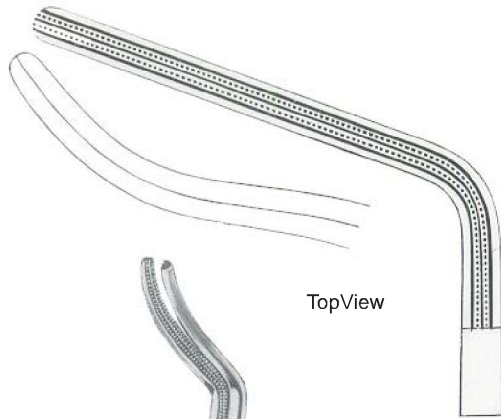

TopView



**DeBakey**  
29-09665-27  
27cm/10 1/2"



**DeBakey**  
29-09669-24  
24cm/9 1/2"

LigatureClamps



**DeBakey**  
29-09673-24  
24cm/9 1/2"





DeBakey

Ligatureclamp,  
Aorticclamp



**DeBakey**  
29-09677-26  
26.5cm/10 1/2"

**DeBakey-Semb**  
29-09677-25  
25cm/10"

DeBakey-Semb

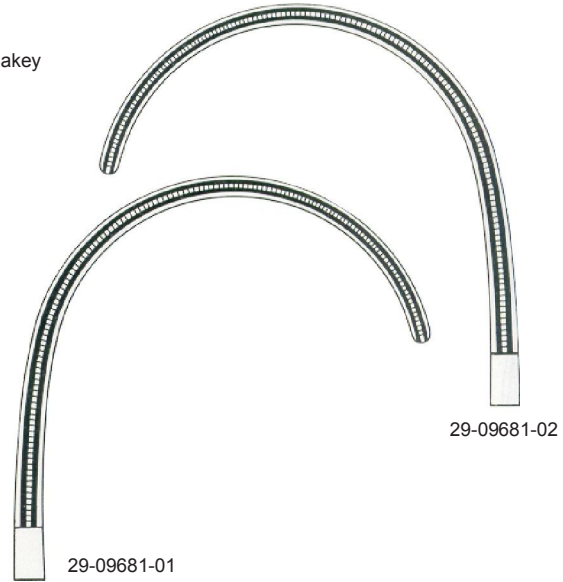

29-09681-01

29-09681-02

Aorticclamp



**Weber**  
26cm/10 1/4"



**Satinsky/DeBakey**

Tangential occlusion clamps



DeBakey



Set of 5 purchase.  
29-09685-00

29-09685-20  
20cm/8"

29-09685-25  
25cm/10"

29-09685-26  
26cm/10 1/4"

29-09685-27  
27cm/10 1/2"

29-09885-28  
28cm/11"



**Glover**

29-09689-01 19.5cm/7 3/4"  
29-09689-02 21.0cm/8 1/4"

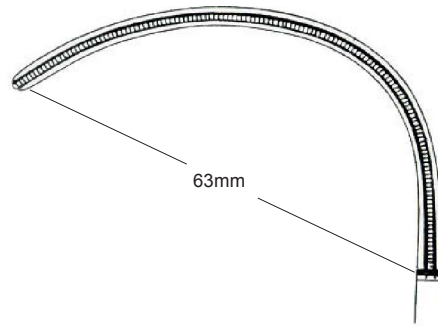

Anastomosis

63mm

29-09689-01

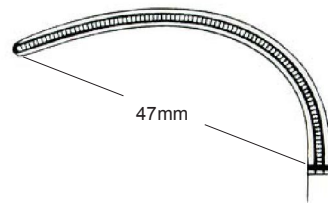

47mm

29-09689-02



DeBakey



**Lambert-Kay**  
21cm/8 1/4"



Aortic anastomosis clamps

29-09693-21

29-09695-21



**DeBakey**  
29-09699-17  
17cm/6 3/4"



**Beck**  
29-09703-17  
17cm/6 3/4"



DeBakey



**DeBakey**  
29-09707-16  
16cm/6 1/4"

Graduated

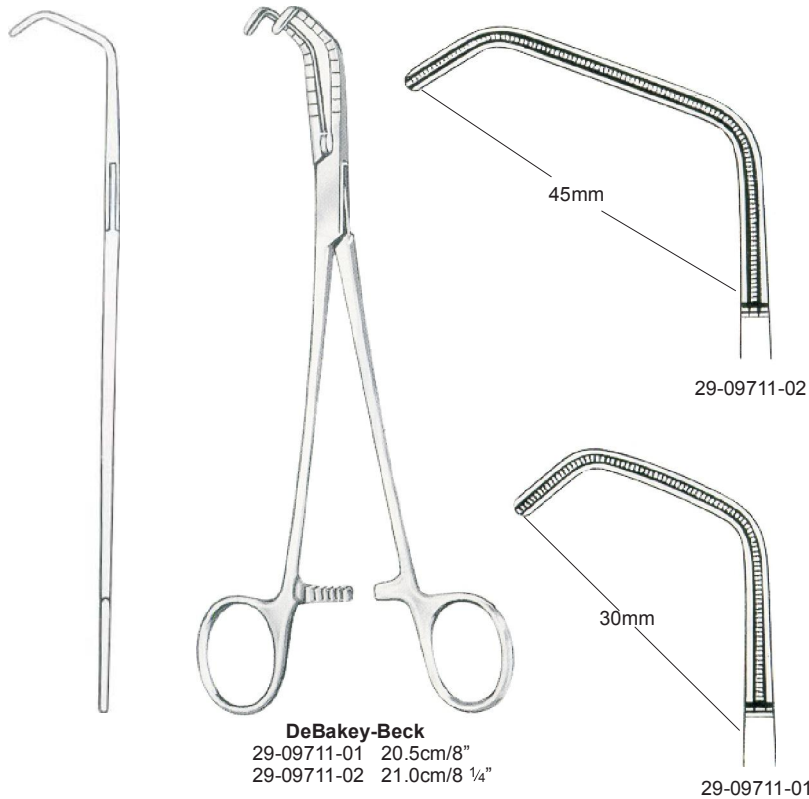

**DeBakey-Beck**  
29-09711-01 20.5cm/8"  
29-09711-02 21.0cm/8 1/4"

29-09711-02

29-09711-01



29-09714-00



15°  
29-09715-15



30°  
29-09715-30

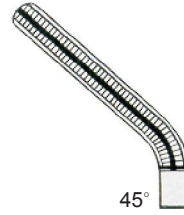

45°  
29-09715-45

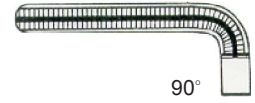

90°  
29-09715-90



29-09718-00



15°  
29-09719-15



30°  
29-09719-30



45°  
29-09719-45

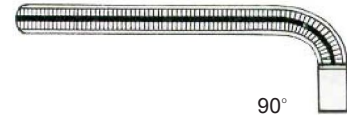

90°  
29-09719-90



**Dardik**  
17cm/6 3/4"



DeBakey



29-09723-20  
20cm/8"

29-09723-22  
22cm/8 3/4"

29-09723-24  
24cm/9 1/2"

29-09723-30  
30.5cm/12"

Multipurposeclamps



DeBakey

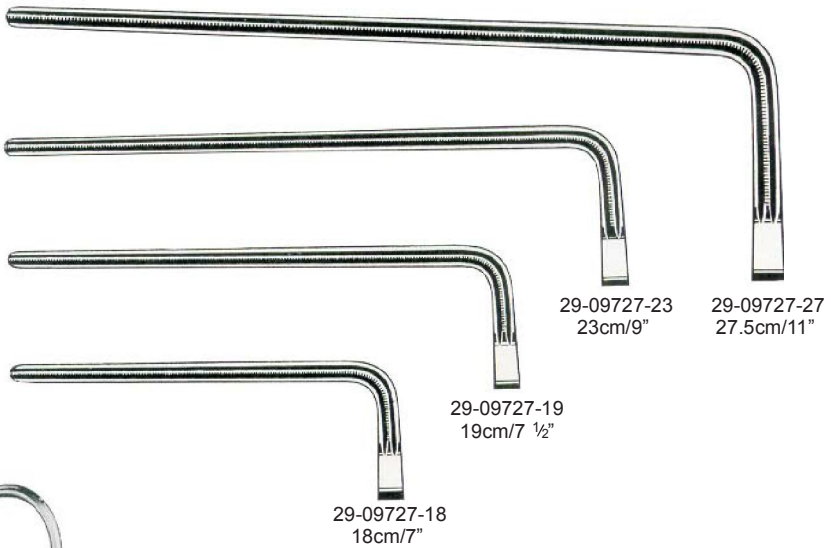

29-09727-23  
23cm/9"

29-09727-27  
27.5cm/11"

29-09727-19  
19cm/7 1/2"

29-09727-18  
18cm/7"





Aortic anastomosis clamps

**Morris-DeBakey**

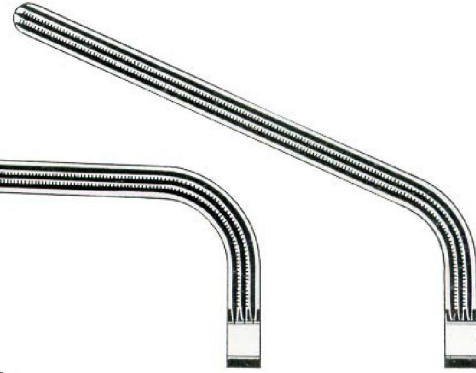

29-09731-18  
18cm/7"

29-09731-20  
20cm/8"



29-09731-23  
23cm/9"

29-09731-25  
25cm/10"



**Glover**  
29-09735-24  
24.5cm/9 3/4"

Aortaaneurysmclamps



DeBakey

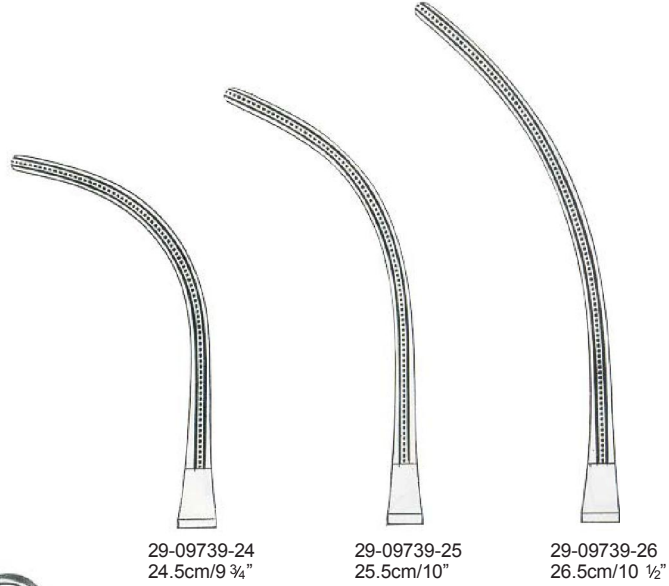

Coarctationclamps



Straight	cm/in	Curved
29-09742-21	21.5cm/8 1/2"	29-09743-21
29-09742-23	23.0cm/9"	29-09743-23
29-09742-27	27.0cm/10 1/2"	29-09743-27
29-09742-31	31.5cm/12 1/2"	29-09743-31



DeBakey



**Mosquito**  
12cm/4 3/4"

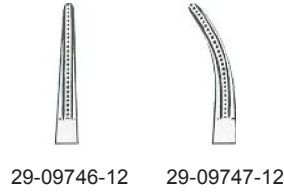

29-09746-12

29-09747-12

Atraumahemostaticforceps



**DeBakey-Pean**

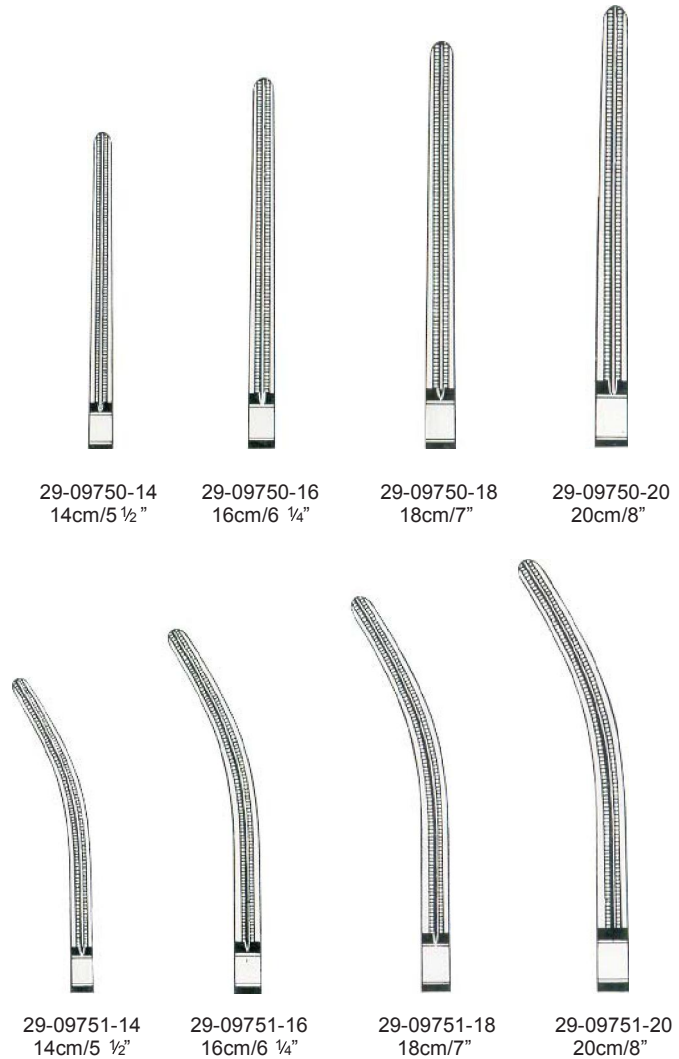

29-09750-14  
14cm/5 1/2"

29-09750-16  
16cm/6 1/4"

29-09750-18  
18cm/7"

29-09750-20  
20cm/8"

29-09751-14  
14cm/5 1/2"

29-09751-16  
16cm/6 1/4"

29-09751-18  
18cm/7"

29-09751-20  
20cm/8"

Multipurposeclamps



DeBakey



DeBakey-Rankin

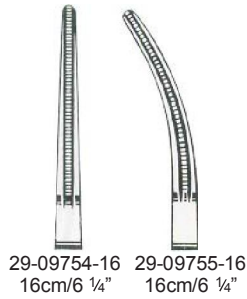

29-09754-16 16cm/6 1/4"  
29-09755-16 16cm/6 1/4"



Cooley

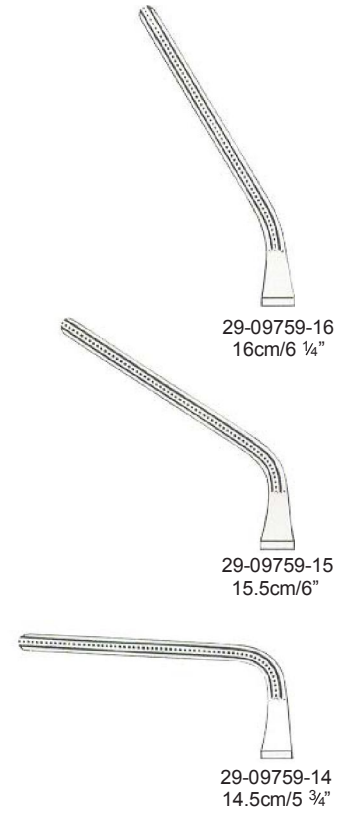

29-09759-16  
16cm/6 1/4"

29-09759-15  
15.5cm/6"

29-09759-14  
14.5cm/5 3/4"



DeBakey  
29-09762-17  
17cm/6 3/4"

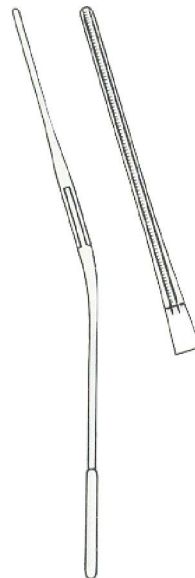

29-09763-17



29-09765-17



29-09767-17



DeBakey

LigatureClamps

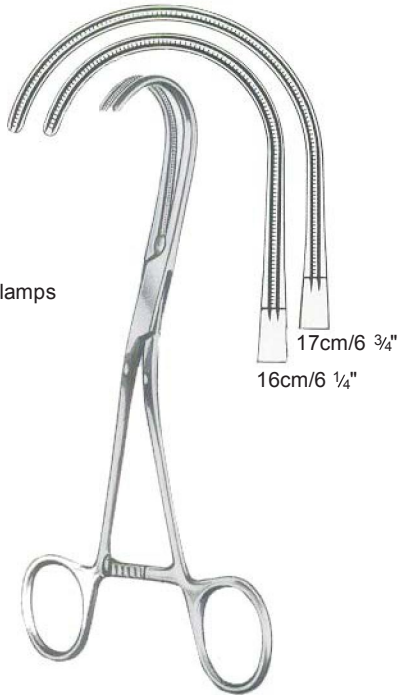

29-09771-16 16cm/6 1/4"  
29-09771-17 17cm/6 3/4"



Derra-DeBakey  
17cm/6 3/4"



AnastomosisClamps

ProfundaClamps



Gregory



29-09779-14  
14cm/5 1/2"



29-09779-16  
16cm/6 1/4"



29-09779-18  
18cm/7"



**DeBakey**  
 29-09782-12  
 12cm/4 3/4"



**DeBakey**



**DeBakey**



29-09783-10  
 10cm/4"



29-09783-11  
 10.5cm/4 1/2"

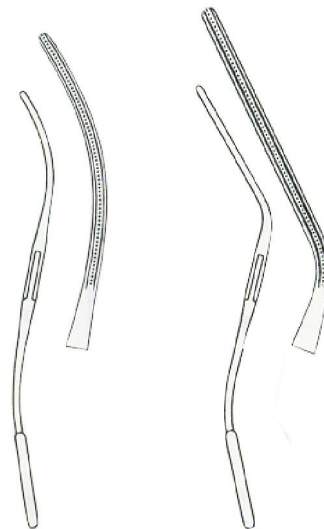

29-09783-12  
 12cm/4 3/4"

29-09783-13  
 13cm/5"



CarotidClamps



**Javid**  
 29-09787-18  
 18cm/7"



**Javid**  
 29-09787-19  
 19cm/7 1/2"

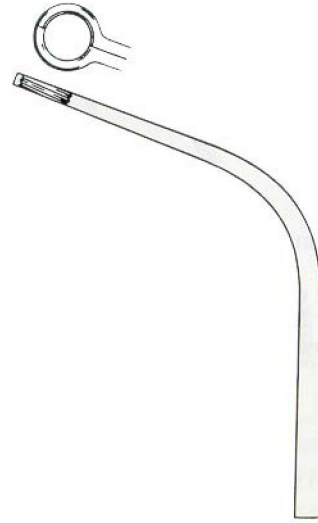

**Cooley**

Charriere (French)	Length cm	
24	16	29-09789-24
26	16	29-09789-26
28	20	29-09789-28
30	20	29-09789-30
32	20	29-09789-32
36	20	29-09789-36



Cooley

CoarctationClamps



**Cooley**  
29-09792-17  
17cm/6 3/4"



29-09793-17  
17cm/6 3/4"

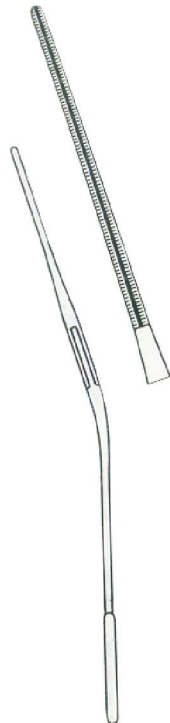

29-09795-17  
17cm/6 3/4"



29-09797-17  
17cm/6 3/4"



**Cooley**  
 29-09799-20  
 20cm/8"



**Cooley**



**Cooley**



29-09801-03  
 17cm/6 3/4"



29-09801-02  
 15.5cm/6"



29-09801-01  
 15cm/6"



**Cooley**  
 29-09803-17  
 17cm/6 3/4"

Anastomosisclamps



Cooley



Cooley

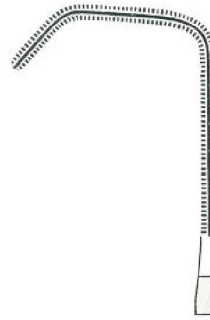

29-09807-01  
16.5cm/6 1/2"

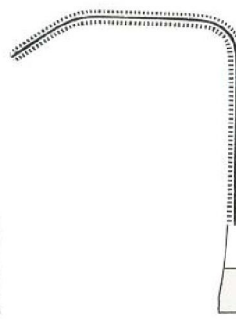

29-09807-02  
16.5cm/6 1/2"

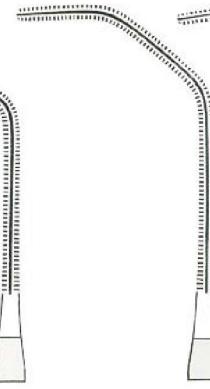

29-09807-03  
17.5cm/7"

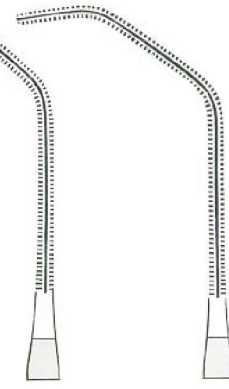

29-09807-04  
17.5cm/7"

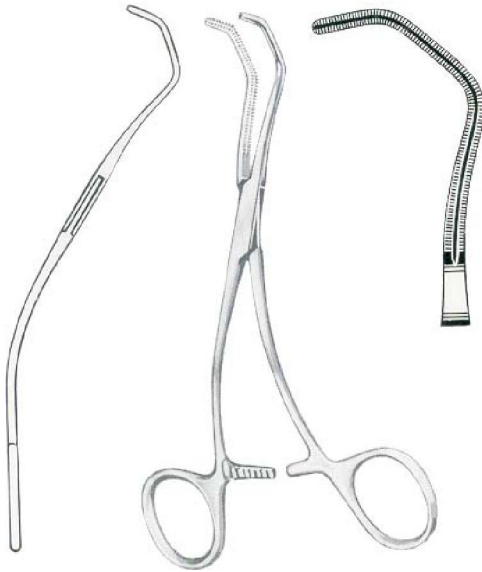

Cooley  
29-09811-16  
16cm/6 1/4"

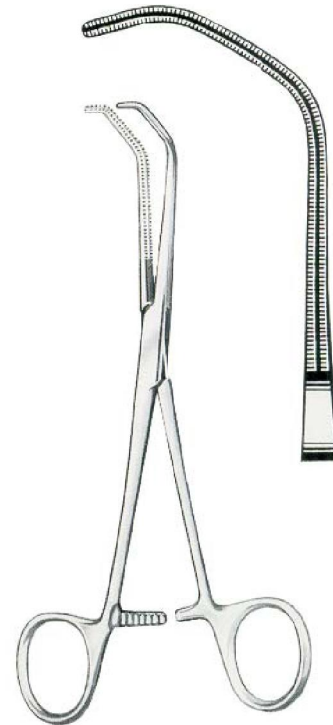

Beck  
29-09815-17  
17cm/6 3/4"



Cooley



Cooley-Derra



29-09819-16  
16cm/6 1/4"



29-09819-17  
17cm/6 3/4"

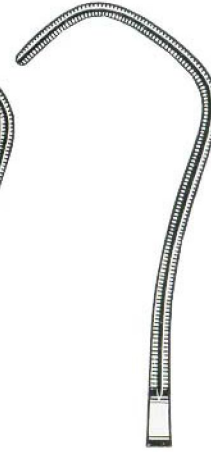

29-09819-18  
18cm/7"



Cooley

29-09823-16 16cm/6 1/4"  
29-09823-17 17cm/6 3/4"



16cm/6 1/4"

17cm/6 3/4"

Ligatureclamps







Fig.



Fig.

Fig.	Straight
1	29-09842-01
2	29-09842-02
3	29-09842-03
4	29-09842-04
5	29-09842-05
6	29-09842-06
7	29-09842-07
8	29-09842-08
9	29-09842-09

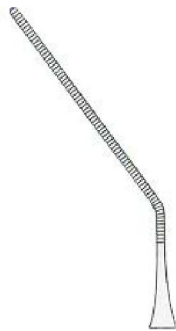

Fig.	Angled
1	29-09843-01
2	29-09843-02
3	29-09843-03
4	29-09843-04
5	29-09843-05
6	29-09843-06
7	29-09843-07
8	29-09843-08
9	29-09843-09



Fig.	Curved
1	29-09845-01
2	29-09845-02
3	29-09845-03
4	29-09845-04
5	29-09845-05
6	29-09845-06
7	29-09845-07
8	29-09845-08
9	29-09845-09





29-09847-01  
13cm/5"



29-09847-02  
13cm/5"



29-09847-03  
13cm/5"



**Castaneda**



29-09847-04  
15cm/6"



29-09847-05  
15cm/6"



29-09847-06  
15cm/6"

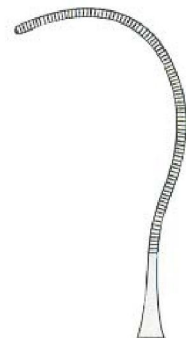

29-09847-07  
15cm/6"



**Cooley**  
29-09849-01  
25cm/10"



**Cooley**  
29-09849-02  
33cm/13"



**Cooley**  
29-09849-03  
30cm/12"



**Cooley**  
29-09849-04  
30cm/12"



**Cooley**  
29-09849-05  
35cm/13 3/4"

Tourniquets



**Rumel-Belmont**  
29-09851-32 3.2mm Ø  
29-09851-64 6.4mm Ø

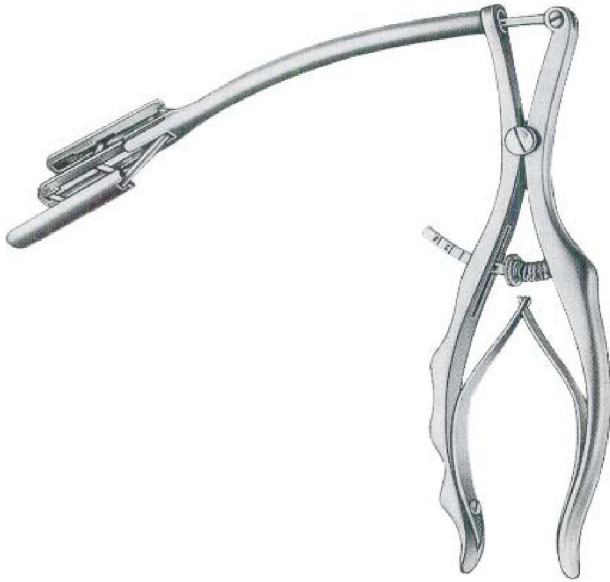

**Cooley**  
29-09853-00



**Gerbode**  
29-09854-00



**Tubbs**  
29-09855-00



DeBakey

mm Ø	19cm/7 1/2"	35cm/14"
0.5	29-09857-05	29-09858-05
1.0	29-09857-10	29-09858-10
1.5	29-09857-15	29-09858-15
2.0	29-09857-20	29-09858-20
2.5	29-09857-25	29-09858-25
3.0	29-09857-30	29-09858-30
3.5	29-09857-35	29-09858-35
4.0	29-09857-40	29-09858-40
4.5	29-09857-45	29-09858-45
5.0	29-09857-50	29-09858-50
7.0	29-09857-70	29-09858-70
9.0	29-09857-90	29-09858-90

Malleable

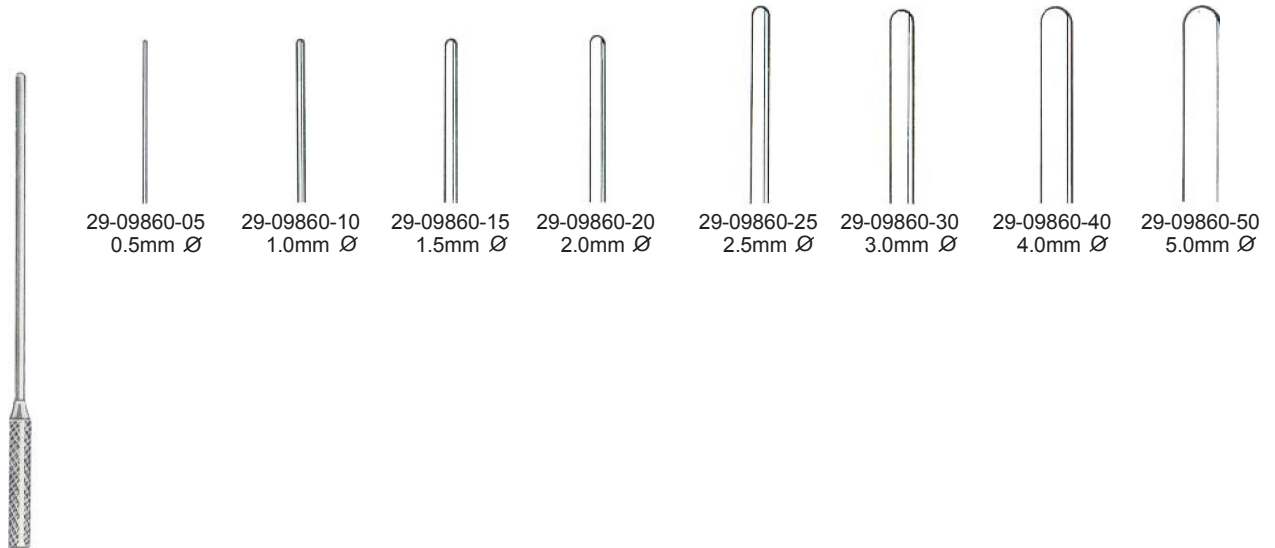

29-09860-05  
0.5mm Ø

29-09860-10  
1.0mm Ø

29-09860-15  
1.5mm Ø

29-09860-20  
2.0mm Ø

29-09860-25  
2.5mm Ø

29-09860-30  
3.0mm Ø

29-09860-40  
4.0mm Ø

29-09860-50  
5.0mm Ø

Cooley  
13cm/5"

29



Children  
30-09862-07  
7cm/2 ¾"

**Weiss**

Adults  
30-09862-09  
9cm/3 ½"



Children  
30-09864-07  
7cm/2 ¾"

**Weiss**

Adults  
30-09864-09  
9cm/3 ½"



**Park**  
30-09868-08  
8cm/3 ¼"

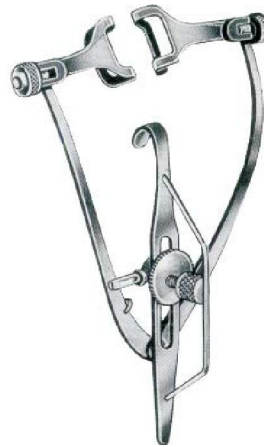

**Park-Guyton**  
30-09870-08  
8cm/3 ¼"



**Park-Maumenee**  
30-09872-08  
8cm/3 ¼"



Children  
30-09874-03  
3cm/1 ¼"

**Barraquer (Colibri)**

Adults  
30-09874-04  
4cm/1 ½"



**Barraquer**  
30-09876-04  
4cm/1 ½"



**Bowman**  
30-09878-07  
7cm/2 ¾"





**Sauer**  
30-09880-03  
3cm/1 ¼"

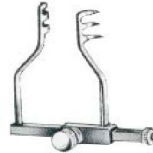

**Goldstein**  
30-09884-03  
3cm/1 ¼"



**Pley**  
30-09888-06  
6cm/2 ¼"

Forlefteye

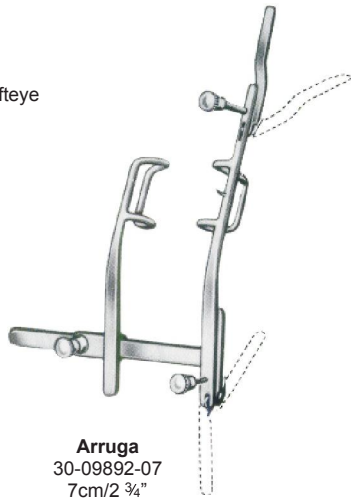

**Arruga**  
30-09892-07  
7cm/2 ¾"

Forrighteye

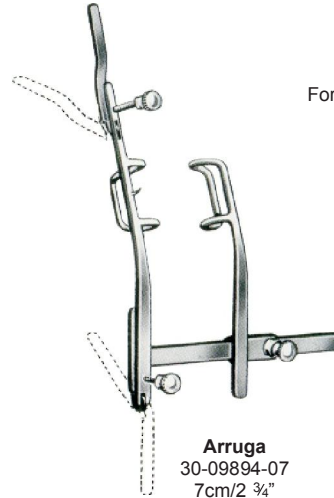

**Arruga**  
30-09894-07  
7cm/2 ¾"



**Mellinger-Axenfeld**  
30-09898-07  
7cm/2 ¾"



**Mellinger-Axenfeld**  
30-09900-07  
7cm/2 ¾"

**Children**  
30-09904-05  
5cm/2 ¾"



**Mellinger**  
Adults  
30-09904-07  
7cm/2 ¾"



Children **Mellinger Beard** Adults  
30-09908-05 30-09908-07  
5cm/2" 7cm/2 3/4"

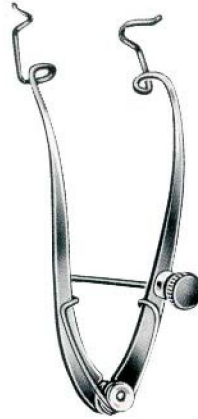

**Knapp Clark**  
30-09912-08  
8cm/3 1/4"



Children **Graefe** Adults  
30-09916-06 30-09916-09  
6cm/2 1/2" 9cm/3 1/2"



Children **Cook** Adults  
30-09920-04 30-09920-05  
4cm/1 1/2" 5cm/2"



**Lancaster**  
30-09924-08  
8cm/3 1/4"



Children **Williams** Adults  
30-09928-07 30-09928-08  
7cm/2 3/4" 8cm/3 1/4"



**Lister-Burch**  
30-09932-08  
8cm/3 1/4"



**Weiss**  
30-09936-08  
8cm/3 1/4"



**Murdock**  
30-09940-05  
5cm/2"

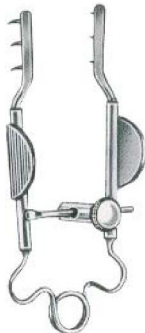

**Mueller**  
30-09944-07  
7cm/2 3/4"



**Critchett**  
30-09948-06  
6cm/2 1/2"



**Castroviejo**  
30-09952-08  
8cm/3 1/4"



**Stevenson**  
30-09956-07  
7cm/2 3/4"



**Agricola**  
30-09960-04  
4cm/1 1/2"



**Schepens**  
 30-09964-13  
 13cm/5"



**Desmarres**  
 30-09968-13  
 13cm/5"



8mm  
**Conway**  
 30-09972-13  
 13cm/5"



**Desmarres**  
 13cm/5"



30-09976-12  
 12mm



30-09976-14  
 14mm



30-09976-16  
 16mm



30-09976-18  
 18mm

Lidplate



**Jaeger**  
 30-09980-11  
 11cm/4 1/2"





**Jaeger**  
30-09997-01



30-09997-02    30-09997-03    30-09997-04    30-09999-01    30-09999-02    30-09999-03    30-09999-04



30-10001-01    30-10001-02    30-10001-03    30-10001-04



**Jaeger-Grieshaber**    30-10003-01    30-10003-02    30-10003-03    30-10003-04    **Jaeger-Grieshaber**    30-10005-01    30-10005-02    30-10005-03    30-10005-04

30





**Wessely-Grieshaber**

30-010007-01 4mm  
 30-010007-02 5mm  
 30-010007-03 6mm  
 30-010007-04 7mm

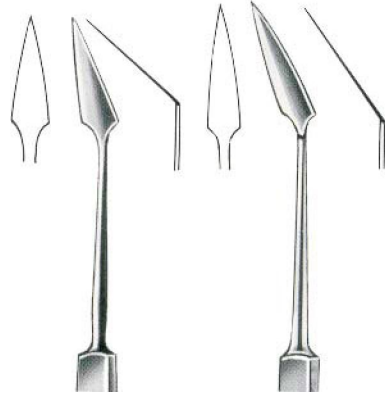

**Wiener**  
 30-010009-13

**Berens**  
 30-010011-13



**Papst**  
 30-010013-13



**Castroviejo**  
 30-010015-13



**Castroviejo**  
 30-010019-01  
 9cm/3 1/2"



**Castroviejo**  
 30-010019-02  
 9cm/3 1/2"

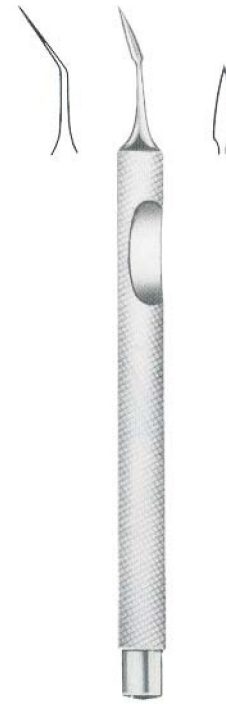

**Castroviejo**  
 30-010019-03  
 9cm/3 1/2"



**Mod.Hamburg**  
30-010023-12



**Graefe**  
30-010025-13



30-010027-01



**Weber**  
30-010027-02



30-010027-03



**Bowman**  
30-010029-04  
0.4mm



**Bowman**  
30-010029-05  
0.5mm



**Bowman**  
30-010029-06  
0.6mm



**Bowman**  
30-010029-07  
0.7mm



**Bowman**  
30-010029-08  
0.8mm



Left **Bowman** Right  
30-010031-01 30-010031-02



30-010033-01



**Knapp**  
30-010033-02



30-010033-03



30-010035-05  
5mm



**Ziegler**  
30-010035-06  
6mm



30-010035-07  
7mm



**Dean**  
30-010037-13



**Zigler**  
30-010039-11  
3½ mm



**Sato**  
30-010041-12



**Sichel**  
30-010043-13



**Graefe**  
30-010045-13



**Graefe**  
30-010047-13



30-010049-01



**Kuhnt**  
30-010049-02



30-010049-03



30-010049-04



**Paton**  
30-010051-12



**Elsching**  
30-010053-13



**Took**  
30-010055-12



30-010057-01



**Desmarres**  
30-010057-02



30-010057-03



**Gill**  
30-010059-12



**Anderson-Critchett**  
30-010061-12



**Lundsgaard**  
30-010063-12



**Guyton-Lundsgaard**  
30-010065-12



**Barken**  
30-010067-12



**Scheie**  
30-010069-12



**Burch**  
30-010071-12



30-010073-12



30-010075-12



30-010077-12



30-010079-12



30-010081-12



30-010083-12



**Schweiz.Mod.**  
30-010085-12



30-010087-13



30-010089-13



**Levinson**  
30-010091-13



**Alvis**  
30-010093-12



**Francis**  
30-010095-12



**LaForce  
(Golf-Club)**  
30-010097-12



**Davis**  
30-010099-13



**Dix**  
30-010101-13



**Ellis**  
30-010103-11



**Plango**  
30-010105-12



**Nicati**  
30-010107-12



**Walton**  
30-010109-12



**Walton**  
30-010111-12



**Meyer**  
30-010113-12



**Green**  
30-010115-13



**Rollet**  
30-010117-12



**Graefe**  
30-010119-13



**Graefe**  
30-010121-19



**Graefe**  
30-010123-13



**Becker  
Melleable**  
30-010125-13



**Tuebingen**  
30-010127-13



**Mod. Bonn**  
 30-10129-14  
 14cm/5 1/2"



**Hirschmann**  
 Blunt  
 30-10132-10



**Graefe**  
 Sharp  
 30-10133-12



**Graefe**  
 Blunt  
 30-10136-12



**Knolle**  
 30-10140-01

◀ Blunt ▶



**Jaffe-Knolle**  
 30-10140-02



**O'Connor**  
 30-10144-12



**Wiener**

Sharp  
 30-10047-13

Blunt  
 30-10148-13



**Hirschmann**  
 30-10152-13



**Graefe**  
 30-10156-13



**McGannan**  
 30-10160-13  
 13cm/5"



**Meyer-Schwickerath**  
 30-10164-13  
 13cm/5"



**Jaeger**  
 30-10168-01



**Jaeger**  
 30-10168-02



**Left Arruga**  
 30-10172-01



**Right**  
 30-10172-02



**Jameson**  
 30-10176-12



**Culler**  
 30-10180-12



**Green**  
 30-10184-13





**Guthrie**  
30-10188-12



**Guthrie**  
30-10190-13



**Berens**  
30-10194-12



**Knapp  
Blunt**  
30-10198-13



**Rollet  
Sharp**  
30-10201-12



**Rollet**  
30-10204-12



**Fink  
Blunt**  
30-10208-12



**Right**  
30-10212-01

**Left**  
30-10212-02

10.5cm/4 1/4"



**Knapp-Rollet**  
30-10216-02



**Flexible**  
30-10216-03



30-10216-04



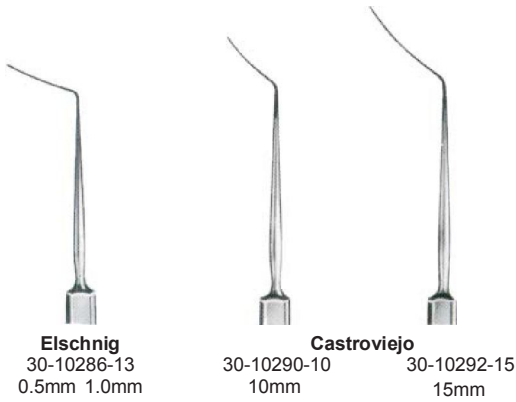
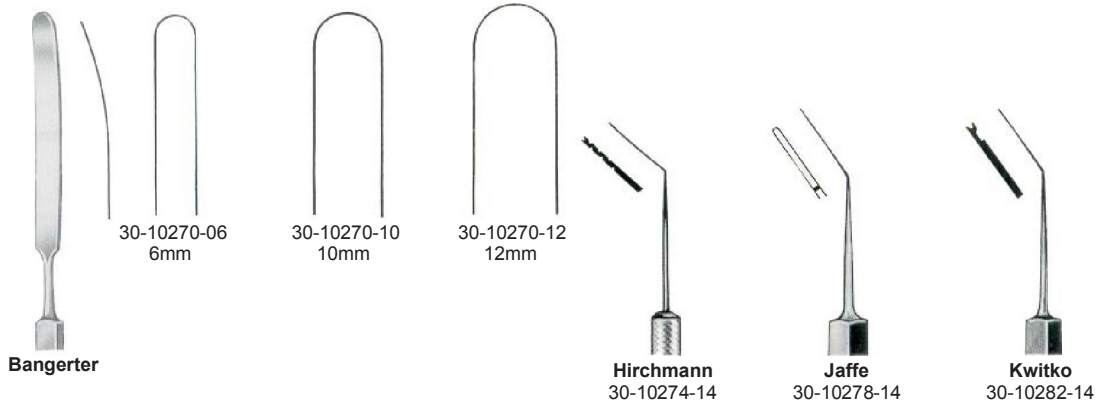

Width of Spatula

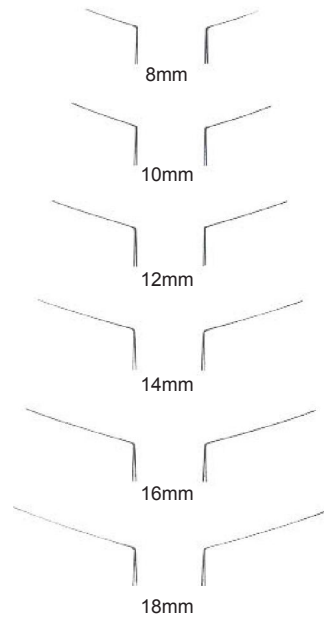





EnucleationScoops

Small  
30-10348-16

Large  
30-10348-20

Wells

ChalazionCurettes



## ExenterationScoops

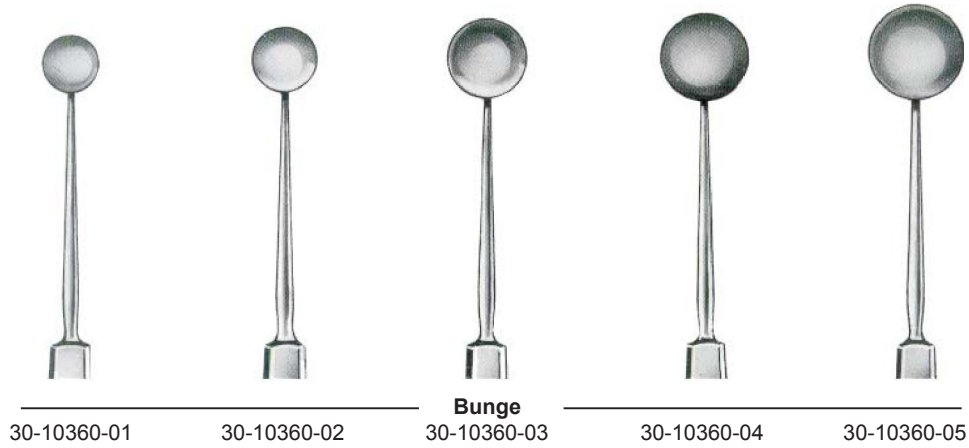

ChalazionCurette,Double

**Axenfeld**  
30-10364-13  
13cm/5"



LachrymalSacDissector

**Lang**  
30-10368-13  
13cm/5"



## Irrigating Cannulas

Straight



**Binkhorst**  
 30-10372-01  
 22gauge

Right



**Binkhorst**  
 30-10372-02  
 22gauge

Left



**Binkhorst**  
 30-10372-03  
 22gauge

## ProbePoint



**Bonn**  
 30-10372-04  
 20gauge



**Bonn**  
 30-10372-05  
 19gauge



**Hamburg**  
 30-10372-06  
 23gauge



**Simcoe**  
 30-10376-01  
 23gauge

Irrigation/AspirationCannulas



**Gills-Welsh**  
 30-10376-02  
 25/23gauge



**Knolle-Kelmann**  
 30-10380-01  
 22gauge



**Nevyas**  
 30-10380-02  
 22gauge

CystotomeCannulas



**Kratz**  
 30-10380-03  
 22gauge

LensMainpulationCannulas



**Freeman**  
 30-10384-01  
 27gauge



## CortexAspirationCannulas



## CapsulePolishingCannulas

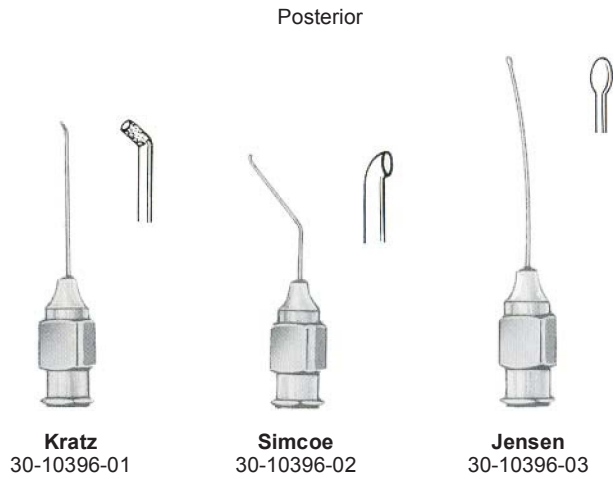

## Lachrymal Cannulas



30-10400-01  
25gauge



30-10400-02  
25gauge



30-10400-03  
25gauge



30-10400-04  
25gauge



**Bonn**  
30-10400-05  
19gauge



**Bangerter**  
30-10400-06 40mm  
30-10401-06 60mm



**Anel**  
30-10400-07  
23gauge



**Anel**  
30-10400-08  
23gauge

Alpha-ChymotrypsinCannula



30-10404-00  
23gauge

AirInjectionCannula



**Sauter**  
30-10406-00  
27gauge

CollarButtonCannulas



**Graether**

Straight  
30-10408-01

Angled  
30-10408-02

KnifeCannula



**Sato**  
30-10408-03  
23gauge

A/C PunctureCannula



**Schreck**  
30-10408-04  
21gauge



**Castroviejo**  
30-10412-15



**Castroviejo**  
30-10412-20  
20mm



**Holth**  
30-10416-01



**Haitz**  
30-10416-02



**West**  
30-10420-16  
16cm/6 1/4"



**West**  
30-10422-16  
16cm/6 1/4"

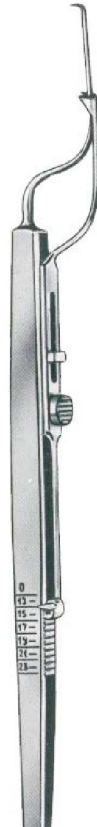

**Connin-Amsler**  
30-10426-13  
13cm/5"



**Wilder**  
30-10430-01



**Wilder**  
30-10430-02



**Wilder**  
30-10430-03





**Castroviejo**  
30-010434-12



**Muldoon**  
30-10438-10



**Simpson**  
30-10442-01



30-10446-01

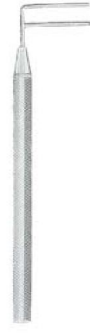

30-10446-02

**Bowman  
Fig.**

0000/0000	30-10450-04
000/000	30-10450-03
00/00	30-10450-02
0/0	30-10450-01
1/1	30-10450-11
2/2	30-10450-22
3/3	30-10450-33
4/4	30-10450-44
5/5	30-10450-55
6/6	30-10450-66
7/7	30-10450-77
8/8	30-10450-88

Martial: NSGermanSilver



**Bowman  
Fig.**

0000/000	30-10452-03
000/00	30-10452-02
00/0	30-10452-00
0/1	30-10452-01
1/2	30-10452-12
2/3	30-10452-23
3/4	30-10452-34
4/5	30-10452-45
5/6	30-10452-56
6/7	30-10452-67
7/8	30-10452-78



**Bowman  
Fig.**

0000/000	30-10454-03
000/00	30-10454-02
00/0	30-10454-00
0/1	30-10454-01
1/2	30-10454-12
2/3	30-10454-23
3/4	30-10454-34
4/5	30-10454-45
5/6	30-10454-56
6/7	30-10454-67
7/8	30-10454-78





**Castroviejo**

**Castroviejo**  
Width of Spatula

	mm
30-10458-05	0.50
30-10458-07	0.75
30-10458-10	1.00



**Castroviejo**  
30-10462-12



**Wheeler**  
30-10466-12



**Lindner**  
30-10470-13



**Smith-Fisher**  
30-10474-12



**Green**  
30-10478-12



**Dix**  
30-10482-01



**Dix**  
30-10482-02



**Stille**  
30-10486-01



**Stille**  
30-10486-02



30-10490-12



NeedleOnly  
30-10498-01

ChiselOnly  
30-10498-02

GougeOnly  
30-10498-03



30-10500-13

Instrumentation for D.B. Kirby Operations



30-10502-10

Teeth

30-10506-101:2  
30-10508-102:3

Teeth  
Teeth



30-10510-10  
1:2



**Kirby**  
30-10514-10  
10cm/4"



**Kirby**  
30-10516-10  
10cm/4"



30-10518-10



30-10520-10

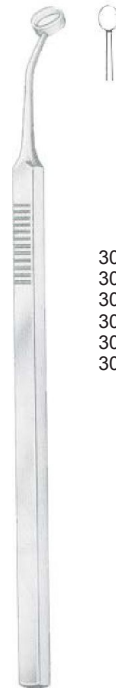

- 30-10524-01 =3.0x3.5mm
- 30-10524-02 =3.0x4.0mm
- 30-10524-03 =3.0x4.5mm
- 30-10524-04 =3.5x4.0mm
- 30-10524-05 =3.5x4.5mm
- 30-10524-06 =3.5x5.0mm

Bores



- 30-10528-01 =2.75mm
- 30-10528-02 =3.00mm
- 30-10528-03 =3.25mm
- 30-10528-04 =3.75mm
- 30-10528-05 =4.00mm
- 30-10528-06 =4.25mm
- 30-10528-07 =4.50mm
- 30-10528-08 =4.75mm
- 30-10528-09 =5.00mm
- 30-10528-10 =6.00mm
- 30-10528-11 =8.00mm

Bores



- 30-10532-01 =3.00mm
- 30-10532-02 =3.25mm
- 30-10532-03 =3.50mm
- 30-10532-04 =3.75mm
- 30-10532-05 =4.00mm
- 30-10532-06 =4.25mm
- 30-10532-07 =4.50mm
- 30-10532-08 =4.75mm
- 30-10532-09 =5.00mm
- 30-10532-10 =5.50mm
- 30-10532-11 =6.00mm
- 30-10532-12 =7.00mm
- 30-10532-13 =8.00mm
- 30-10532-14 =9.00mm
- 30-10532-15 =1.11mm

Hoffer



- 30-10536-00  
3-5mm

Hoffer



- 30-10536-01  
3-5-7mm

- 30-10536-02  
3-6-8mm

Hoffer



**Tuebingen**  
30-10540-10  
10cm/4"



**Tuebingen**  
30-10544-08  
8.5cm/3 1/2"



**Paufigue**  
30-10548-10  
10cm/4"



**Barraquer**  
30-10552-10  
10.5cm/4 1/4"



**McPherson**  
30-10556-10  
10cm/4"



**McPherson**  
30-10560-07  
7.5cm/3"



**McCullough**  
 30-10564-09  
 9.5cm/3 3/4"



**McCullough**  
 30-10568-09  
 9.5cm/3 3/4"



**Bonaccoito**  
 30-10572-10  
 10cm/4"



**Bonaccoito**  
 30-10576-10  
 10cm/4"



**30-10580-11**  
 11cm/4 1/2"



**11cm/4 1/2"**



**30-10584-11**  
 1:2



**30-10586-11**  
 2:3



**Nugent**  
 10cm/4"



**30-10590-01**



**30-10590-02**





**Berke**  
10cm/4"

30-10594-10

30-10596-10

**Blascovics**  
30-10600-09  
9cm/3 1/2"

**Blascovics**  
30-10601-09  
9cm/3 1/2"

**Worth**  
30-10604-10  
10cm/4"

**Worth**  
30-10605-10  
10cm/4"



**Jameson**  
30-10608-10  
10cm/4"

**Jameson**  
30-10609-10  
10cm/4"

**Prince**  
30-10612-10  
10cm/4"

**Prince**  
30-10613-10  
10cm/4"

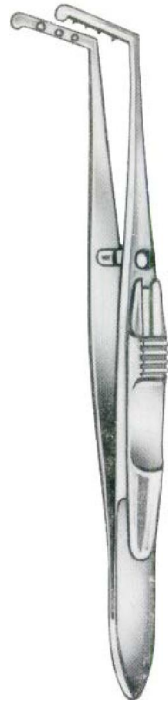

**Sattler**  
 30-10616-10  
 10cm/4"

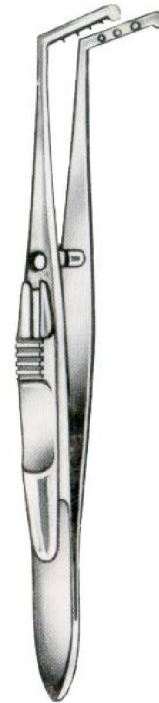

**Sattler**  
 30-10617-10  
 10cm/4"



**Snellen**  
 30-10620-10  
 10cm/4"



**Snellen**  
 30-10621-10  
 10cm/4"



**Erhardt**  
 30-10624-09  
 9cm/3 1/2"



**Barraquer**  
 30-10628-05  
 5.5cm/2 1/4"



**Barraquer**  
 30-10628-07  
 5.5cm/2 1/4"



**Barraquer**  
 30-10628-10  
 5.5cm/2 1/4"



**Hess**  
 30-10632-09  
 9cm/3 1/2"

◀Swisspatterns ▶



**Hess**  
 30-10634-09  
 9cm/3 1/2"

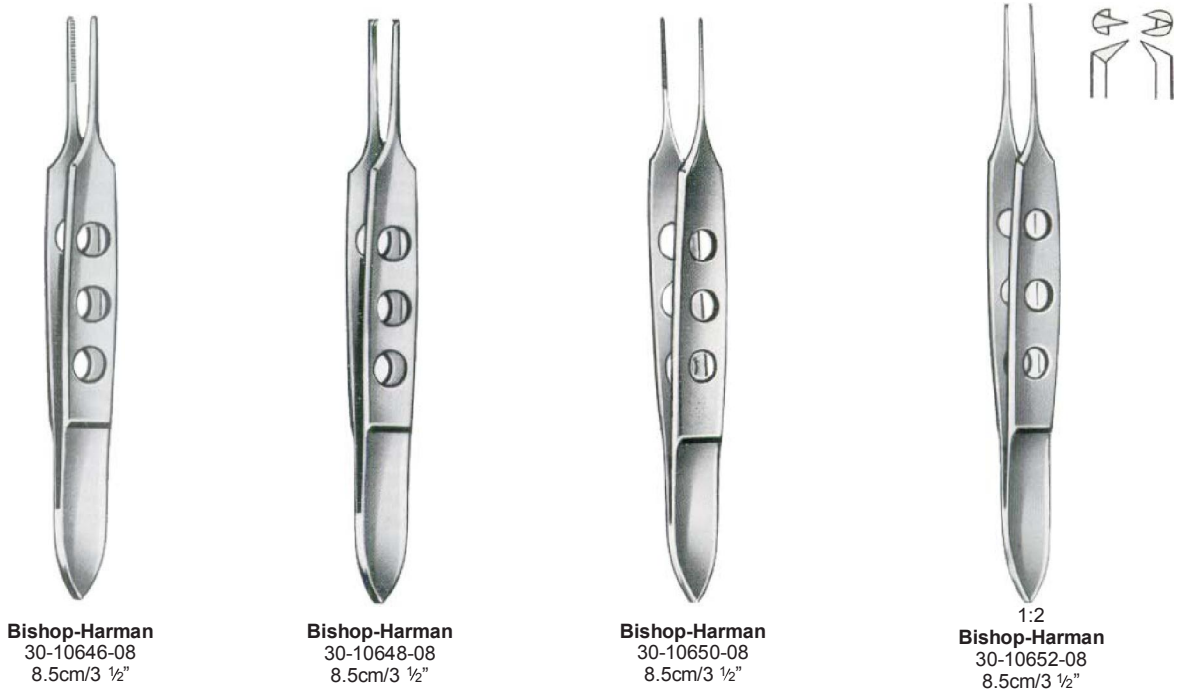
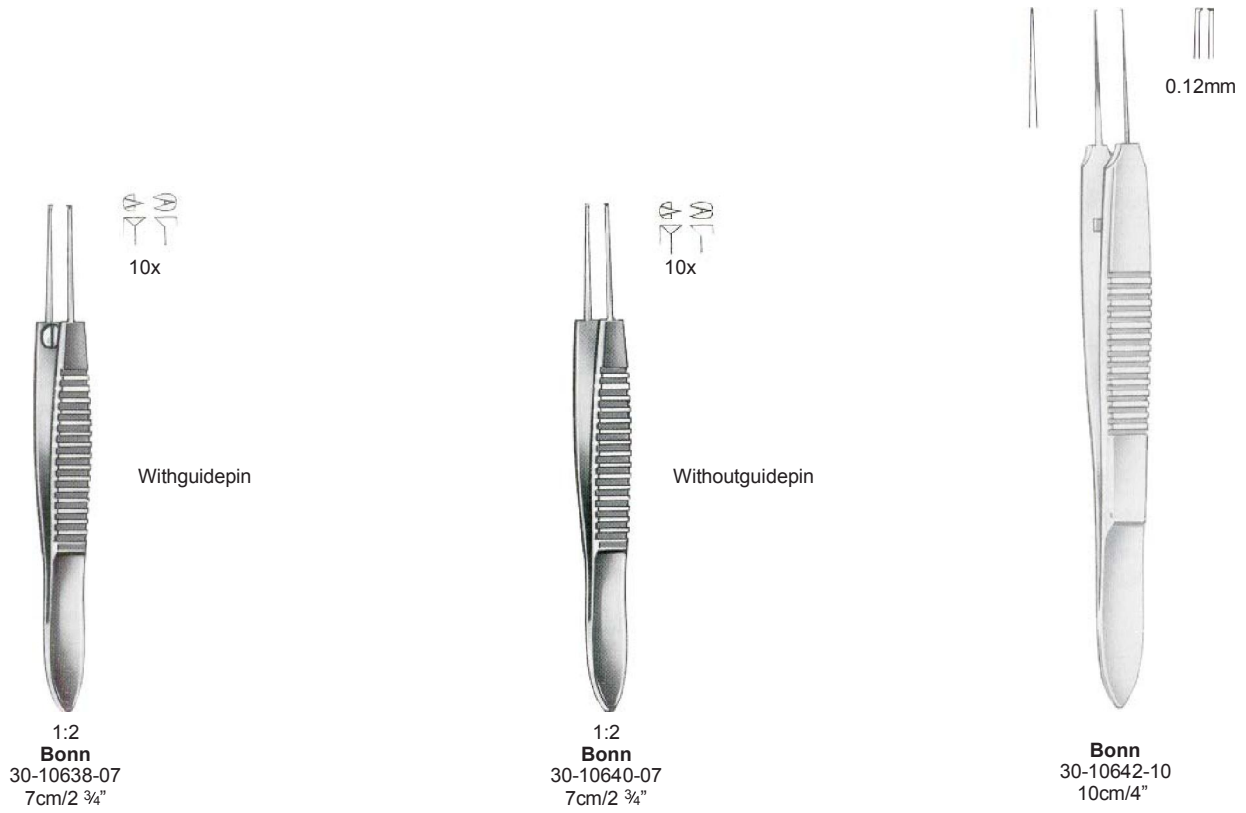



**Graefe**  
30-10656-05 0.5mm  
30-10656-07 0.7mm  
30-10656-10 1.0mm  
7cm/2 3/4"



**Graefe**  
30-10657-05 0.5mm  
30-10657-07 0.7mm  
30-10657-10 1.0mm  
7cm/2 3/4"



**1:2  
Graefe**  
30-10660-05 0.5mm  
30-10660-07 0.7mm  
30-10660-10 1.0mm  
7cm/2 3/4"



**1:2  
Graefe**  
30-10661-05 0.5mm  
30-10661-07 0.7mm  
30-10661-10 1.0mm  
7cm/2 3/4"



**Foerster**  
30-10664-08  
8.5cm/3 1/2"



**Foerster**  
30-10665-08  
8.5cm/3 1/2"



**Foerster**  
30-10668-08  
8.5cm/3 1/2"



**Foerster**  
30-10669-08  
8.5cm/3 1/2"



**Graefe**  
10cm/4"



30-10672-10



30-10673-10



30-10675-10



30-10678-10



30-10679-10



30-10681-10

Conjunctivalforceps



**Stevens**  
10.5cm/4 1/4"



30-10684-10



30-10685-10



30-10687-10



30-10690-10



30-10691-10



30-10693-10



**O'Connor**  
30-10696-10  
10cm/4"



**Stevens**  
30-10700-11  
11cm/4 1/2"



**Stevens**  
30-10701-11  
11cm/4 1/2"





**Fischer**  
30-10705-07  
7cm/2 ¾"

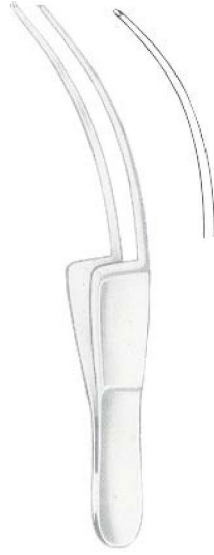

**Fischer-Arit**  
30-10707-07  
7cm/2 ¾"



**Hess**  
30-10711-07  
7cm/2 ¾"



**Hess**  
30-10713-07  
7cm/2 ¾"



Smooth **Chandler** Serrated  
30-10717-01 7cm/2 ¾" 30-10717-02



**Fuchs**  
30-10721-07  
7cm/2 ¾"



**Gill-Hess**  
30-10723-07  
7.5cm/3"



**Gill-Hess** TeethBelow  
30-10727-07 30-10729-07  
7.5cm/3"  
Teethonside

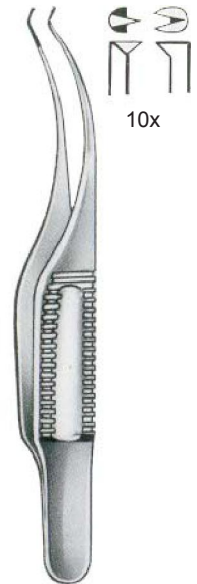

**Barraquer-Katzin**  
(Colibri)  
30-10733-07  
7cm/2 ¾"

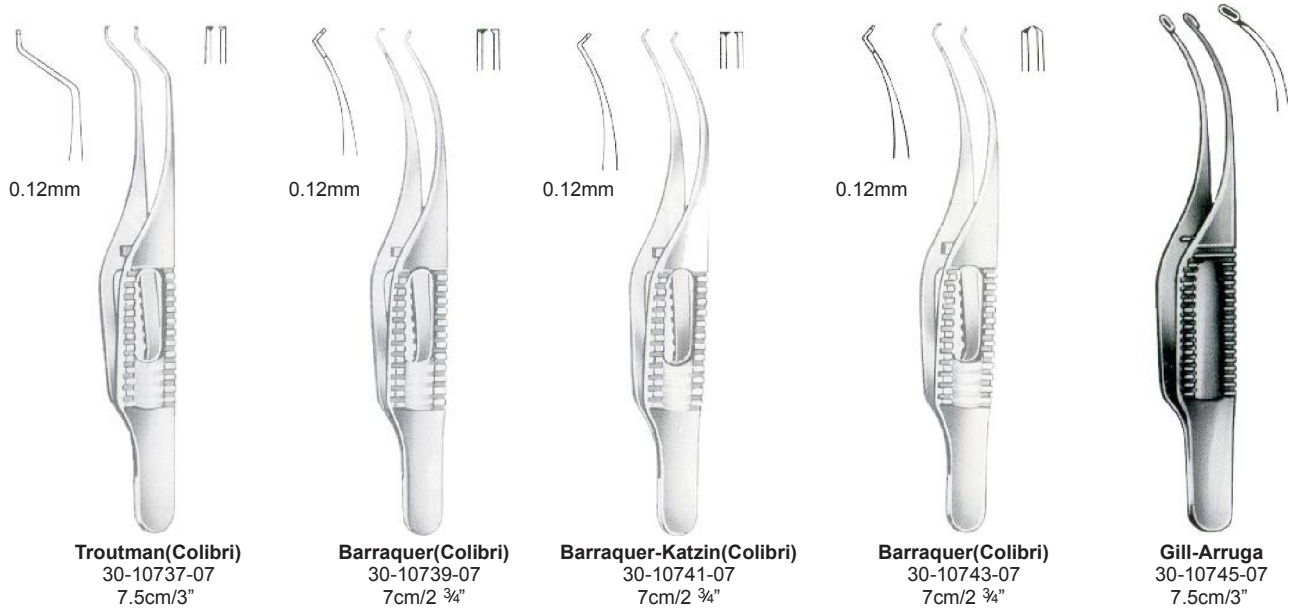



**Fuchs**  
30-10771-07  
7cm/2 ¾"



**Kalt**  
30-10775-10  
10cm/4"



**Terson**  
30-10779-09  
9.5cm/3 ¾"



**Arruga-Nizetic**  
30-10783-10  
10cm/4"



**Castroviejo**  
30-10787-10  
10cm/4"

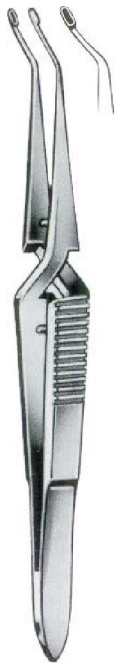

**Castroviejo**  
30-10789-10  
10cm/4"



**Elschnig**  
30-10793-10  
10cm/4"

ForLenImplantation



**Binkhorst**  
30-10797-07  
7cm/2 ¾"



**Arruga**  
30-10801-09  
9.5cm/3 ¾"



**Arruga**  
30-10803-09  
9.5cm/3 ¾"



**Shepard**

Withirrgator  
30-10807-01

Withoutirrgator  
30-10807-02



**Dastoor**  
30-10811-06  
6cm/2 1/4"



**Arruga**  
30-10815-10  
10cm/4"

Calibrated  
**Arruga**  
30-10817-10  
10cm/4"



**Arruga**  
30-10819-10  
10cm/4"

Calibrated  
**Arruga-Elschnig**  
30-10821-10  
10cm/4"



**Knapp**  
30-10824-11  
11cm/4 1/4"



**Ayer**  
30-10828-09  
9cm/3 1/2"



**Ayer**  
30-10830-09  
9cm/3 1/2"



**Lambert**  
30-10834-09  
9cm/3 1/2"



**Desmarres**  
9cm/3 1/2"



30-10838-01



30-10838-02



30-10838-03



## Corneal Fixation Forceps

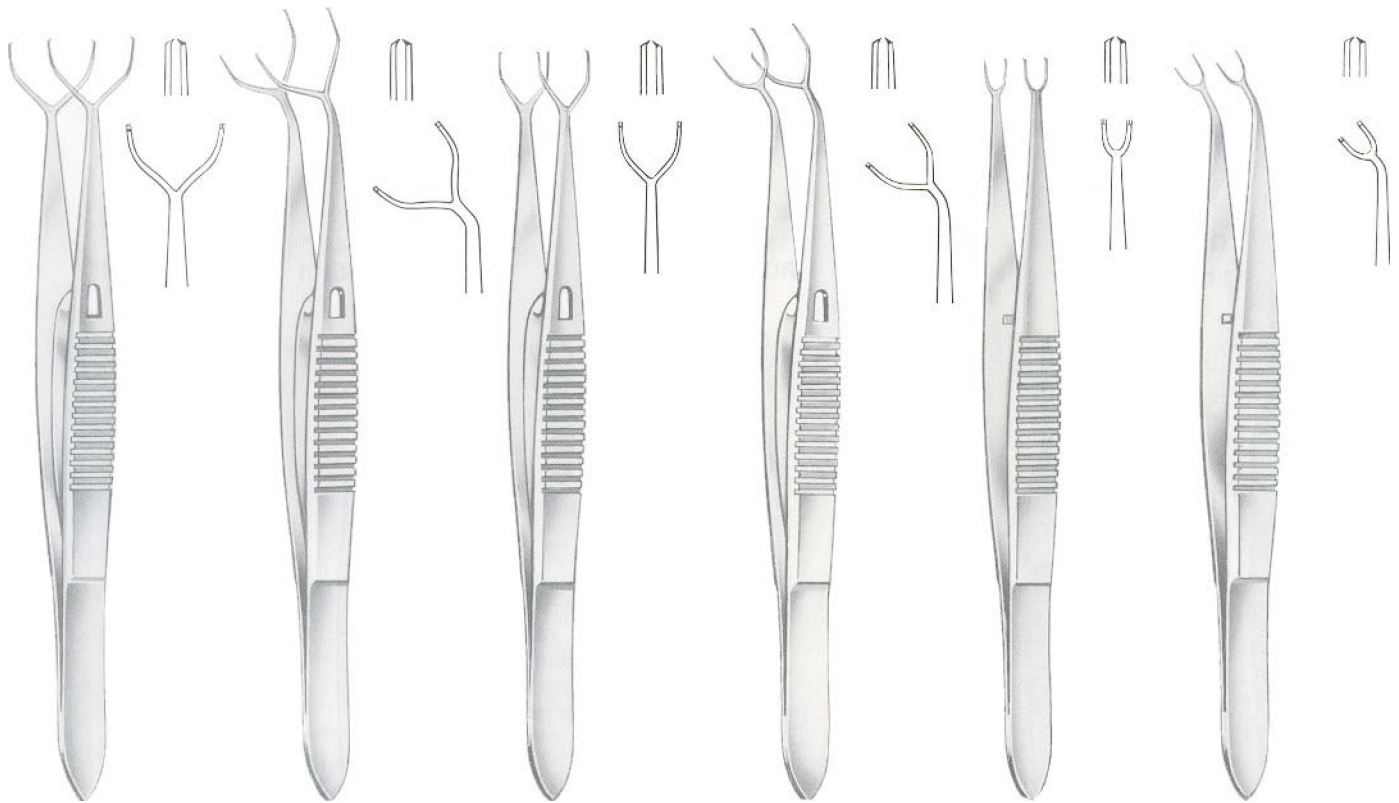

**Kremer**  
 30-10842-10  
 10cm/4"  
 0.12mm

**Kremer**  
 30-10843-10  
 10cm/4"  
 0.12mm

**Arrowsmith**  
 30-10848-10  
 10cm/4"  
 0.12mm

**Arrowsmith**  
 30-10849-10  
 10cm/4"  
 0.12mm

**Bores**  
 30-10852-10  
 10cm/4"  
 0.12mm

**Rubman-Bores**  
 30-10853-10  
 10cm/4"  
 0.12mm





**Graefe**  
11cm/4 1/2"

Without Spring Catch  
30-10858-11

With Spring Catch  
30-10860-11



30-10864-11  
11cm/4 1/2"

2:3Teeth



30-10866-11  
11cm/4 1/2"

3:4Teeth



**Castroviejo**  
30-10870-09  
9cm/3 1/2"



**Castroviejo**  
30-10872-09  
9cm/3 1/2"



**Moorfield**  
30-10876-10  
10cm/4"



**Lester**  
30-10880-021:2  
30-10882-032:3  
9cm/3 1/2"



**Castroviejo**  
10cm/4"

**Straight**  
30-10886-01  
30-10886-02  
30-10886-03  
30-10886-04  
30-10886-05

**Width of Teeth**  
0.12mm  
0.30mm  
0.50mm  
1.00mm  
1.05mm

**Curved**  
30-10887-01  
30-10887-02  
30-10887-03  
30-10887-04  
30-10887-05



**Castroviejo**  
10cm/4"



**Castroviejo**  
30-10890-09  
9cm/3 1/2"



**St.Martin**  
30-10894-07  
7cm/2 ¾"



**Elschnig**  
30-10898-11  
11.5cm/4 ½"



**Elschnig**  
30-10900-11  
11.5cm/4 ½"



**Barraquer**  
30-10904-10  
10cm/4"



**Green**  
10cm/4"

Wide 05mm WithoutSpringCatch  
10mm 30-10908-05  
30-10908-10

Wide 05mm WithSpringCatch  
10mm 30-10910-05  
30-10910-10



30-10913-12  
12cm/4 ¾"



30-10914-12  
12cm/4 ¾"



**Woodruff**  
30-10918-13  
13cm/5"



**Woodruff**  
30-10920-13  
13cm/5"



**Jacobi**  
30-10924-14  
14cm/5 1/2"

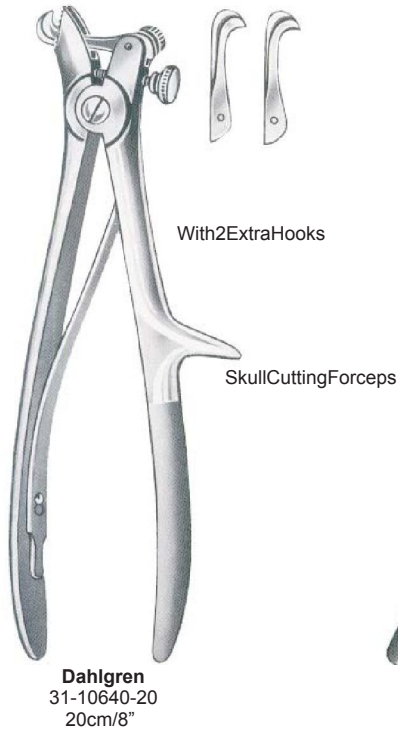
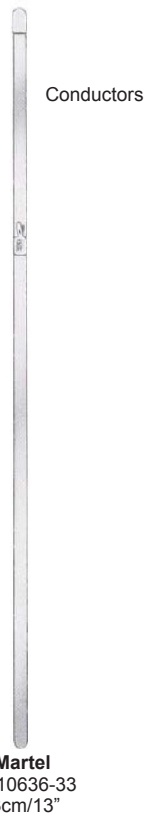

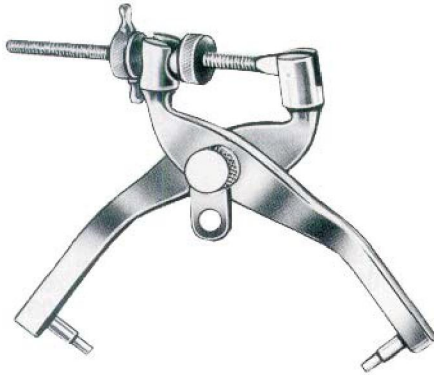

**Crutchfield**  
31-10948-00



**Crutchfield**  
31-10952-00



31-10956-00



**Crutchfield**  
31-10960-00  
Complete With 2 Drills



ApplyingandRemovingForceps



**Raney**  
 31-10964-00  
 16cm/6 1/4"

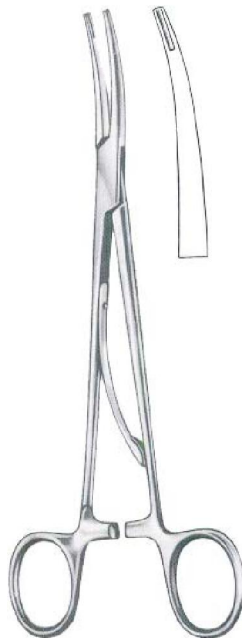

**McKenzie**  
 31-10968-1515cm/6"  
 31-10968-1919cm/7 1/2"



**Olivecrona-Tonnis**  
 31-10972-14

Medial



- mm  
 31-10976-4040x20  
 31-10976-4545x20  
 31-10976-5050x20  
 31-10976-5555x20  
 31-10976-6060x20

Lateral



- mm  
 31-10978-4040x20  
 31-10978-4545x20  
 31-10978-5050x20  
 31-10978-5555x20  
 31-10978-6060x20



- mm  
 31-10980-4040x20  
 31-10980-4545x20  
 31-10980-5050x20  
 31-10980-5555x20  
 31-10980-6060x20



- BluntBlades, For Taking  
 mm  
 31-10982-50 50x25  
 31-10982-50 60x25



- mm  
 31-10984-3535x52  
 31-10984-4040x52  
 31-10984-4545x52  
 31-10984-5050x52  
 31-10984-5555x52  
 31-10984-6060x52  
 31-10984-6565x52  
 31-10984-7070x52

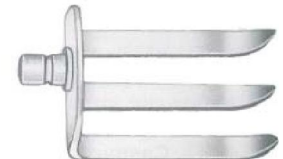

- mm  
 31-10986-3535x37  
 31-10986-4040x37  
 31-10986-4545x37  
 31-10986-5050x37  
 31-10986-5555x37  
 31-10986-6060x37  
 31-10986-6065x37  
 31-10986-6070x37



- mm  
 31-10988-3535x22  
 31-10988-4040x22  
 31-10988-4545x22  
 31-10988-5050x22  
 31-10988-5555x22  
 31-10988-6060x22  
 31-10988-6565x22  
 31-10988-7070x22



- mm  
 31-10990-5050

Hook



- mm  
 31-10992-7070

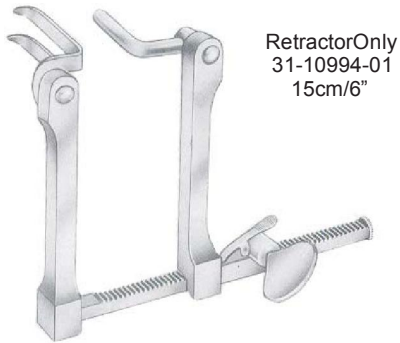

RetractorOnly  
 31-10994-01  
 15cm/6"

**Caspar**  
 31-10994-00

RetractorCompleteWith  
 1BladeEach  
 31-10988-40  
 31-10990-50

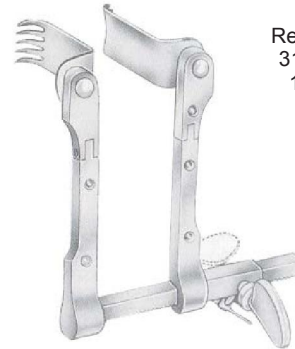

RetractorOnly  
 31-10998-01  
 12cm/4 3/4"

**Caspar**  
 31-10998-00

RetractorCompleteWith  
 1BladeEach  
 31-10976-40  
 31-10978-40

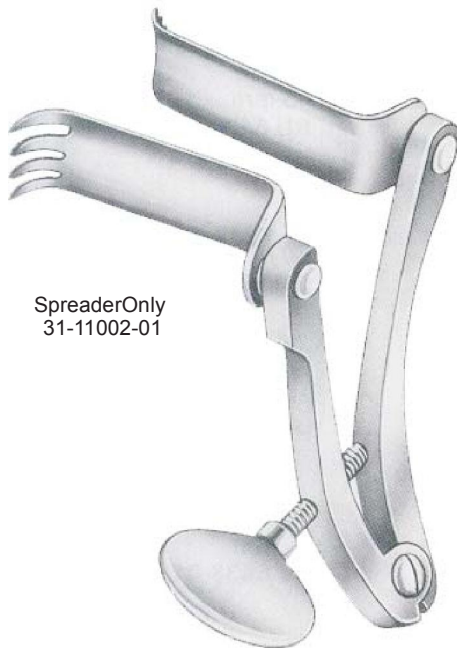

SpreaderOnly  
 31-11002-01

**Caspar**  
 31-11002-00  
 RetractorsOnly  
 SpreaderCompleteWith  
 1BladeEach  
 31-11976-45  
 31-11976-60

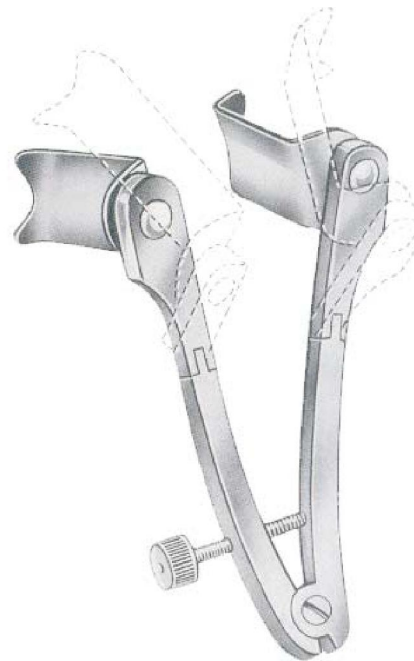

SpreaderOnly  
 31-11006-01

**Caspar**  
 31-11006-00  
 SpreaderOnly  
 ReractorCompleteWith  
 1BladeEach  
 31-11980-40  
 31-11980-40

31-11010-01  
 15cm/6"  
 Retractor only

**Caspar**  
 31-11010-00  
 31-10980-45  
 31-10980-65  
 Retractor complete with  
 1 blade each



31-11014-01  
 15cm/6"  
 Retractor only

**Caspar**  
 31-11014-00  
 31-10980-45  
 31-10980-65  
 Retractor adjustable, con  
 1 blade each

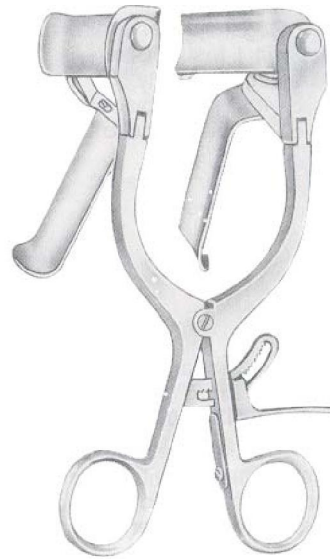

31-11018-01  
 Retractor only  
 with 1 fixed blade

**Caspar**  
 31-11018-00  
 Retractor complete,  
 with 5 blades

31-11018-40  
 40mm



31-11018-45  
 45mm



31-11018-50  
 50mm



31-11018-55  
 55mm



31-11018-60  
 60mm





31-11022-01  
Retractor only

**Cloward**  
 31-11022-00  
 25cm/10"  
 complete with 5 blades

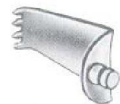

31-11022-40  
15x40mm



31-11022-45  
15x45mm



31-11022-50  
15x50mm



31-11022-55  
15x55mm

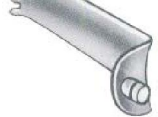

31-11022-60  
15x60mm



31-11026-01  
Retractor only

**Cloward**  
 31-11026-00  
 15cm/6"  
 complete with 5 blades



31-11026-40  
15x40mm



31-11026-45  
15x45mm



31-11026-50  
15x50mm



31-11026-55  
15x55mm

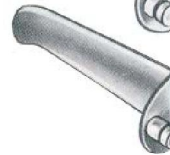

31-11026-60  
15x60mm



**Inge**  
 31-11030-16  
 16cm/6 1/4"



**Inge**  
 31-11032-27  
 27cm/10 3/4"



**Cloward**  
 31-11036-15  
 15cm/6"



**Cloward**  
 31-11040-16  
 16cm/6 1/4"



### Muscleblades



Frame  
31-11044-01

**Hey**  
31-11044-00  
31-11046-00  
23cm/9"



31-11044-50  
20x50mm



31-11044-60  
20x60mm



31-11044-70  
20x70mm

### Vertebra-pins

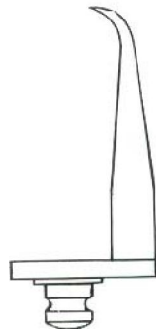

31-11046-50  
50mm



31-11046-60  
60mm



31-11046-70  
70mm



Left-type

Right-type

50x10mm

31-11050-01

31-11052-01

60x10mm

31-11050-02

31-11052-02

70x10mm

31-11050-03

31-11052-03

50x20mm

31-11054-01

31-11056-01

60x20mm

31-11054-02

31-11056-02

70x20mm

31-11054-03

31-11056-03

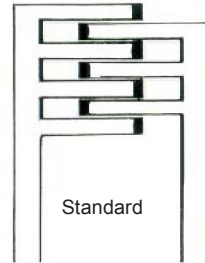
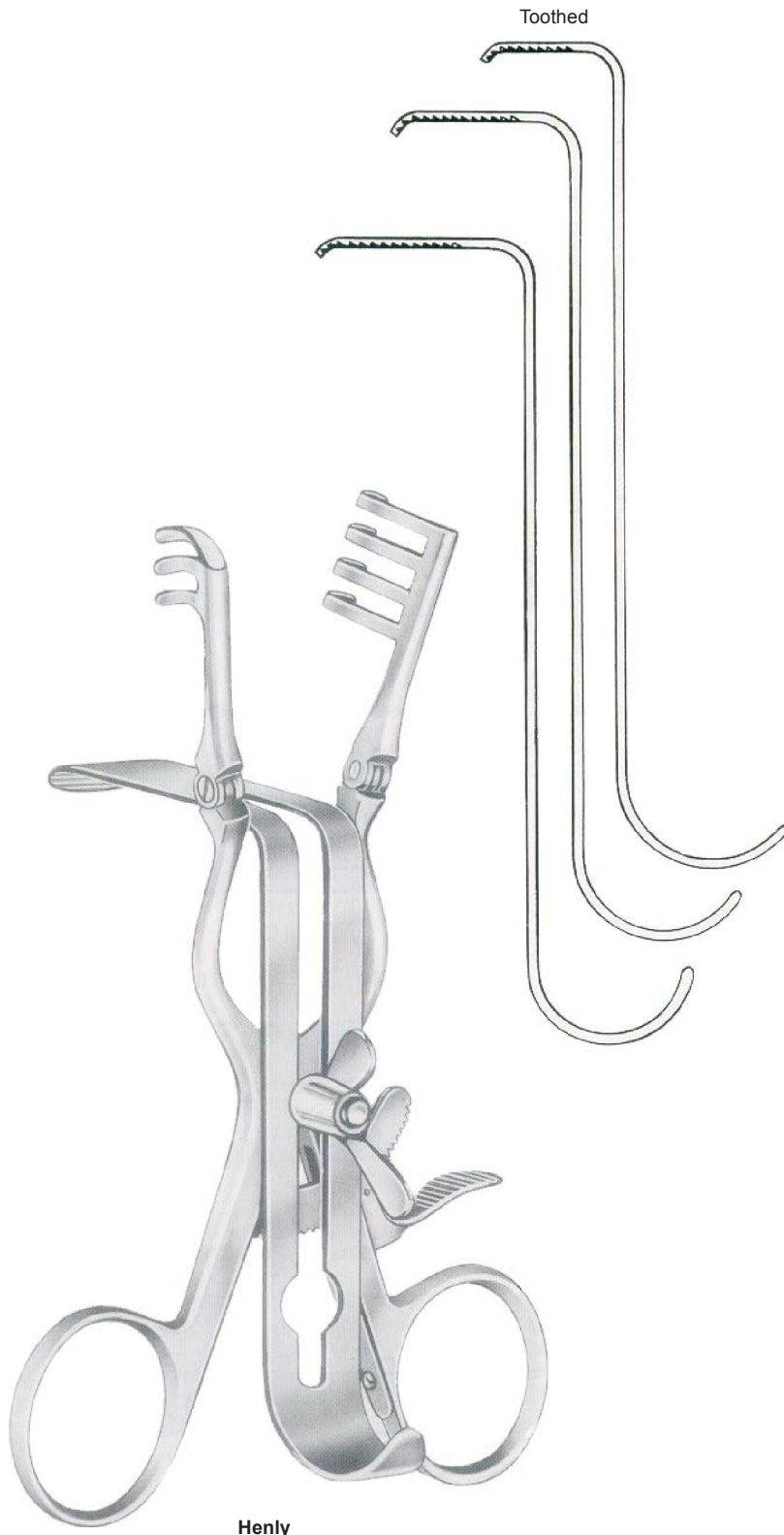

31-11060-00 Complete 31-11062-00  
 14.5cm/5 3/4" Consistingof 17cm/6 3/4"

31-11060-01 Frame 31-11062-01  
 31-11060-21 CentreBlades 31-11060-21  
 31-11060-22 31-11060-22  
 31-11060-23 31-11060-23

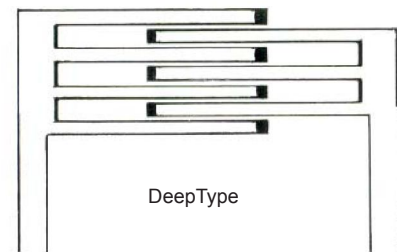

31-11064-00 Complete 31-11066-00  
 14.5cm/5 3/4" Consistingof 17cm/6 3/4"

31-11060-01 CentreBlades 31-11066-01  
 31-11060-21 31-11060-21  
 31-11060-22 31-11060-22  
 31-11060-23 31-11060-23



**Davis**  
 31-11070-24  
 24.5cm/9 3/4"



**Toennis**  
 31-11074-25  
 25cm/10"



**Frazier**  
 31-11078-15

**Hoenn**  
 31-11080-15

**Hoenn**  
 31-11082-15



**Love-Adson**  
 31-11086-16  
 16cm/6 1/2"

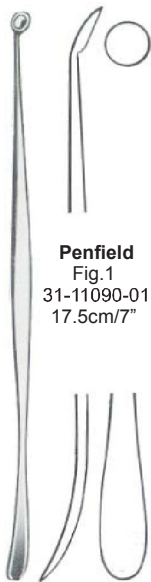

**Penfield**  
 Fig.1  
 31-11090-01  
 17.5cm/7"



**Penfield**  
 Fig.2  
 31-11090-02  
 19.5cm/7 3/4"



**Penfield**  
 Fig.3  
 31-11090-03  
 19.5cm/7 3/4"

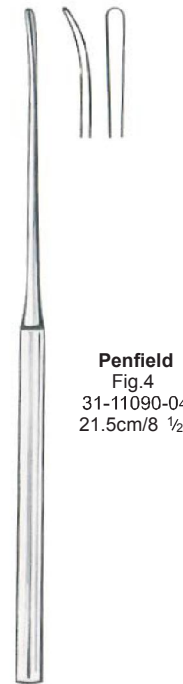

**Penfield**  
 Fig.4  
 31-11090-04  
 21.5cm/8 1/2"



**Penfield**  
 Fig.5  
 31-11090-05  
 29cm/11 1/2"



**Sachs**  
 31-11094-21  
 21cm/8 1/4"

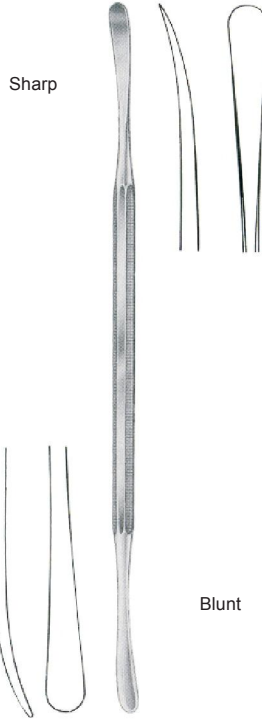

Sharp

Blunt

31-11098-22  
 22cm/8 1/4"

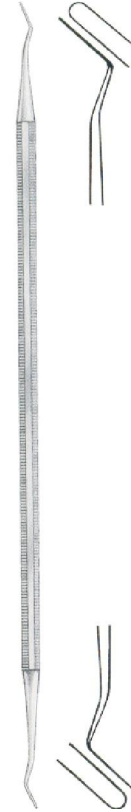

**Woodsen**  
 31-11102-25  
 25cm/10"



**Fragel**  
 31-11106-20  
 20cm/8"



**Fragel**  
 31-11108-20  
 20cm/8"



**Sachs**  
 31-11112-21  
 21cm/8 1/4"



**Milligan**  
31-11116-21  
21cm/8 1/4"



**Olivecrona**  
31-11120-1818cm/7"  
31-11120-2424cm/9 1/2"



**Olivecrona**  
31-11124-19 19.5cm/7 3/4"  
31-11124-24 24cm/9 1/2"



**Horsley**  
31-11128-20  
20cm/8"



**Sachs**  
31-11132-21  
21cm/8 1/4"





**Cushing**  
 17cm/6 ¾"  
 20cm/8"  
 28cm/11"

- 31-11136-17
- 31-11136-20
- 31-11136-28

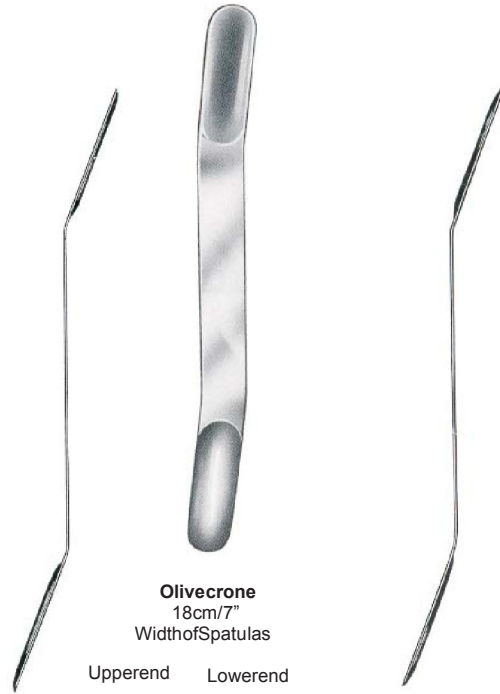

**Olivecrona**  
 18cm/7"  
 WidthofSpatulas

	Upperend	Lowerend	
Concave	mm	mm	Convex
31-11140-01	7	9	31-11142-01
31-11140-02	11	13	31-11142-02
31-11140-03	15	18	31-11142-03
31-11140-04	18	22	31-11142-04



**Heifetz**  
 20cm/8"

WidthofSpatulas		
Upperend		Lowerend
mm		mm
7	31-11144-08	8
10	31-11144-11	11
13	31-11144-14	14
16	31-11144-17	17
19	31-11144-20	20
22	31-11144-25	22



**Heifetz**  
 15.5cm/6"

WidthofSpatulas	
	mm
31-11148-08	8
31-11148-11	11
31-11148-14	14
31-11148-17	17

LengthofSpatulas

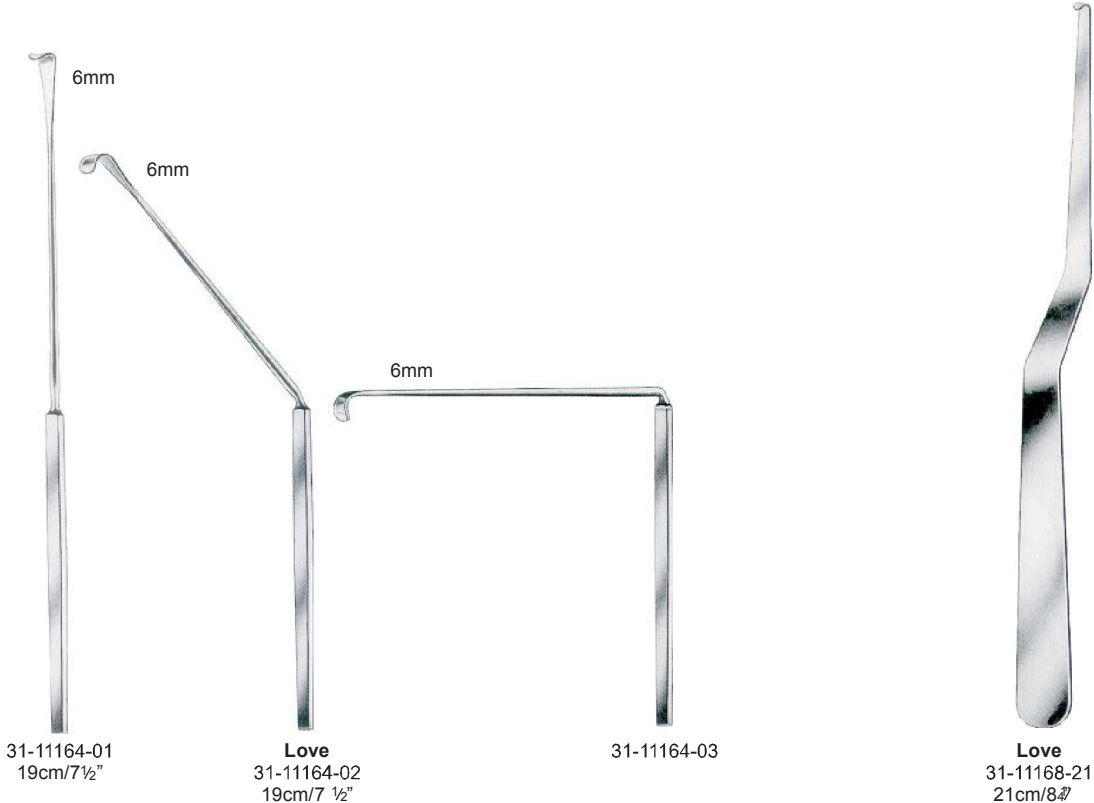
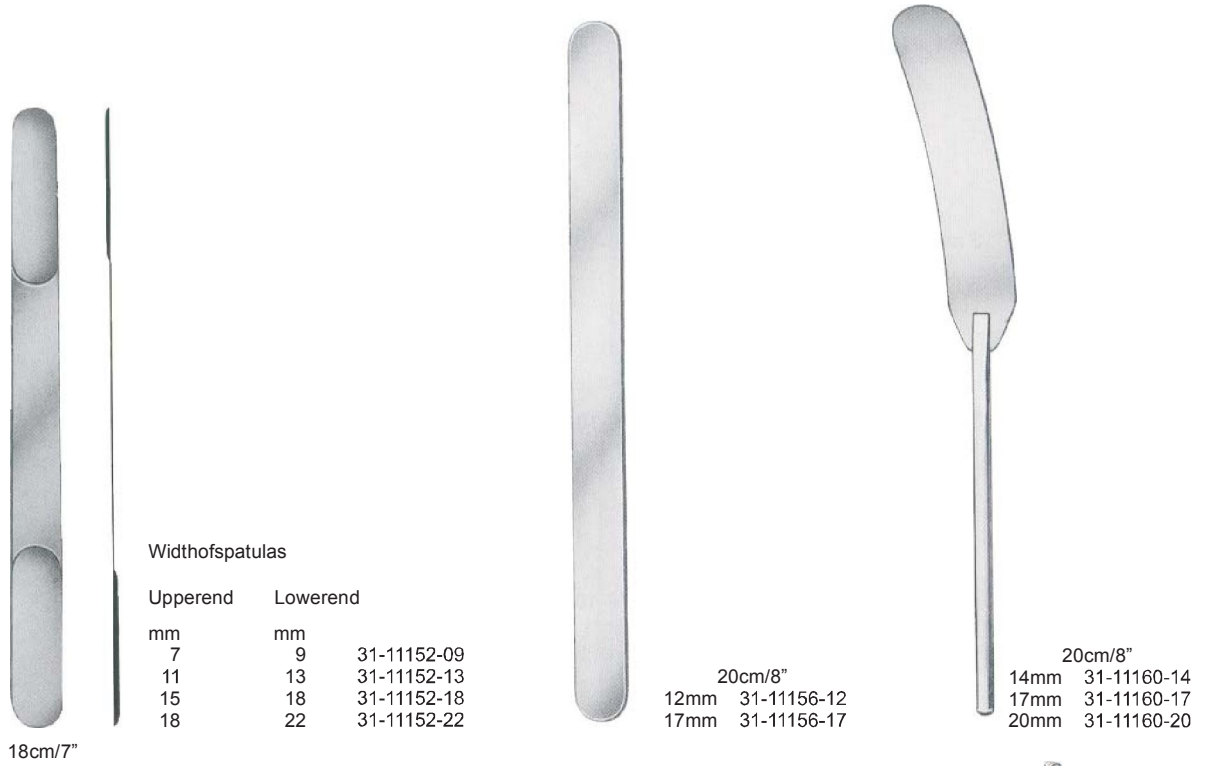

### Lengthofspatulas



70mm  
3mm 31-11172-03

100mm  
31-11174-03



5mm 31-11172-05

31-11174-05



7mm 31-11172-07

31-11174-07



**Love**



**Scoville**  
23cm/9"

7mm 31-11176-07  
9mm 31-11176-09



**Holsher**  
7mm 31-11177-07  
9mm 31-11177-09  
24cm/9 1/2"



8mm 31-11179-08  
13mm 31-11179-13



**Taylor**  
 30x 70mm 31-11180-07 17cm/6 3/4"  
 30x100mm 31-11180-10 17cm/6 3/4"



**Oldberg**  
 21cm/8 1/4"



31-11182-01



31-11182-02



31-11182-03



31-11182-04



**Cushing**  
 31-11184-19 19cm/7 3/4"  
 31-11184-28 28cm/11"



**Smithwick**  
 31-11188-17 17cm/6 1/2"  
 31-11188-21 21cm/8 1/4"



**Cushnig**  
 31-11190-14 14cm/5 1/2"



**Adson**  
 20cm/8"



31-11192-01



31-11192-02

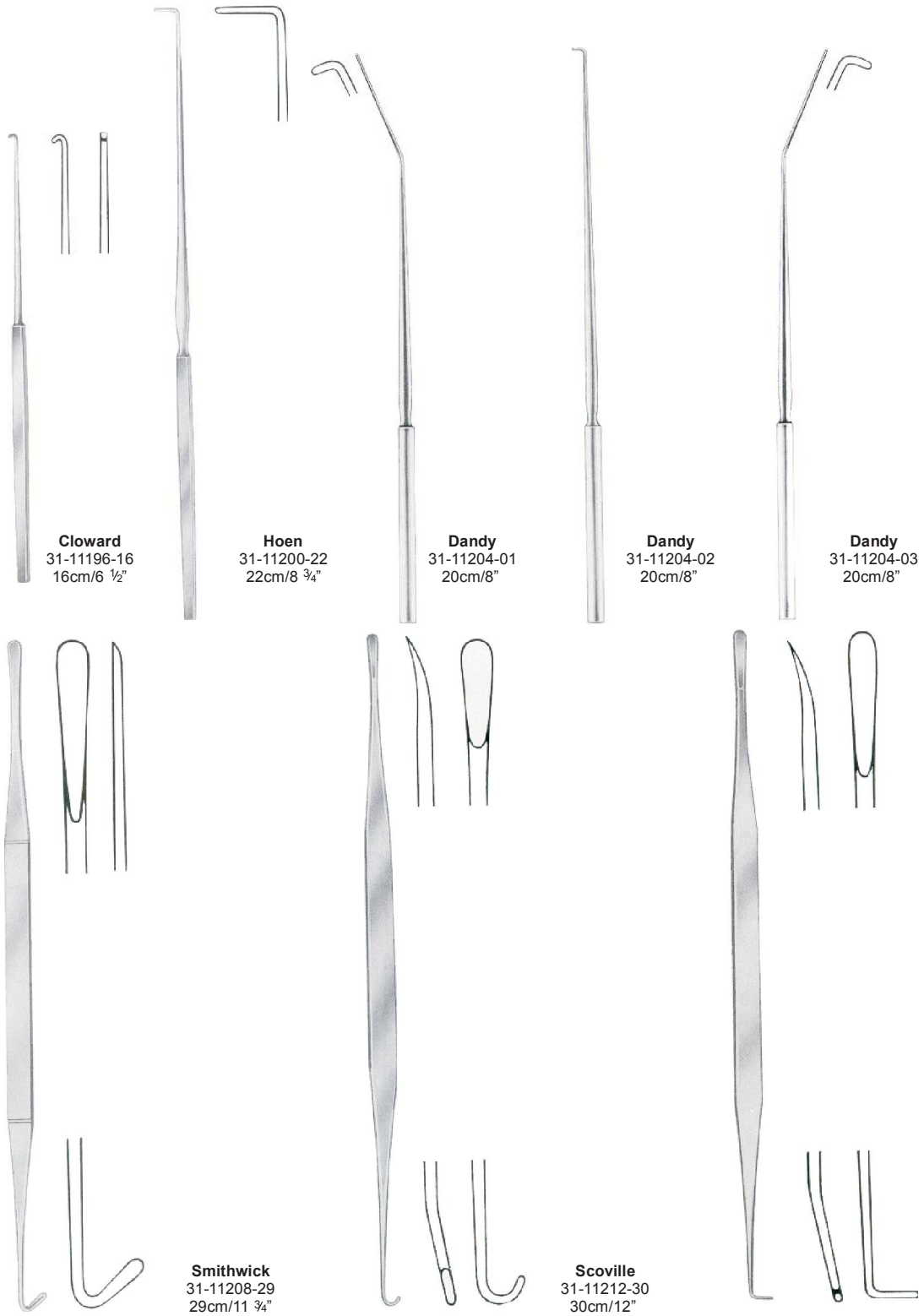



**Graham**  
 31-11218-16  
 16.5cm/6 ½"



**Toennis**  
 31-11222-15  
 15cm/6"



**Frazier**  
 31-11226-13 13cm/5"  
 31-11226-18 18cm/7"



**Toennis**  
 31-11230-13 13cm/5"  
 31-11230-18 18cm/7"



**Olivecrona**  
 31-11234-23  
 23cm/9"



**Olivecrona**  
 31-11236-20  
 20.5cm/8"







**Ferris-Smith-Kerrison**

	Width of Bite	Length of Shaft		
		15cm/6"	20cm/8"	18cm/7"
Cutting Upward	0.6 mm			31-11252-00
	1 mm			31-11252-01
	2 mm			31-11252-02
	3 mm	31-11240-03	31-11246-03	31-11252-03
	4 mm			31-11252-04
Cutting Upward 40°	0.6 mm			31-11254-00
	1 mm			31-11254-01
	2 mm			31-11254-02
	3 mm	31-11242-03	31-11248-03	31-11254-03
	4 mm			31-11254-04
Cutting Downwards	0.6 mm			31-11256-00
	1 mm			31-11256-01
	2 mm			31-11256-02
	3 mm	31-11244-03	31-11250-03	31-11256-03
	4 mm			31-11256-04
	5 mm	31-11244-05	31-11250-05	31-11256-05



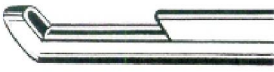



**Ferris-Smith-Kerrison**

		Width of Bite	Length of Shaft		
			15cm/6"	20cm/8"	18cm/7"
Cutting Upward		3mm 5mm	31-11260-03 31-11260-05	31-11266-03 31-11266-05	31-11272-03 31-11272-05
Cutting Upward 40°		3mm 5mm	31-11262-03 31-11262-05	31-11268-03 31-11268-05	
Cutting Downward		3mm 5mm	31-11264-03 31-11264-05	31-11270-03 31-11270-05	31-11274-03 31-11274-05



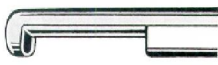

Love-Kerrison

		Width of Bite		Length of Shaft		
		2mm	3mm	15cm/6"	20cm/8"	18cm/7"
Cutting Upward		2mm				31-11286-02
		3mm	31-11278-03	31-11282-03		31-11286-03
		4mm	31-11278-04	31-11282-04		31-11286-04
		5mm	31-11278-05	31-11282-05		31-11286-05
		6mm				31-11286-06
Cutting Upward 40°		2mm				31-11288-02
		3mm				31-11288-03
		4mm				31-11288-04
		5mm				31-11288-05
		6mm				31-11288-06
Cutting Downward		2mm				31-11290-02
		3mm	31-11280-03	31-11284-03		31-11290-03
		4mm	31-11280-04	31-11284-04		31-11290-04
		5mm	31-11280-05	31-11284-05		31-11290-05
		6mm				31-11290-06
Cutting Upward 40°		2mm				31-11292-02
		3mm				31-11292-03
		4mm				31-11292-04
		5mm				31-11292-05
		6mm				31-11292-06



Colclough

		Width of Bite	Length of Shaft	
			15cm/6"	20cm/8"
Cutting Upward		3mm 5mm	31-11296-03 31-11296-05	31-11302-03 31-11302-05
Cutting Upward 40°		3mm 5mm	31-11298-03 31-11298-05	31-11304-03 31-11304-05
Cutting Downward		3mm 5mm	31-11300-03 31-11300-05	31-11306-03 31-11306-05



	LengthOfShaft			
<b>Cushing</b> 2x10cm	5"/13cm	31-11310-01	31-11310-02	31-11310-03
	6"/15cm	31-11312-01	31-11312-02	31-11312-03
	7"/18cm	31-11314-01	31-11314-02	31-11314-03
<b>Love-Grunwald</b> 3x10cm	5"/13cm	31-11316-01	31-11316-02	31-11316-03
	6"/15cm	31-11318-01	31-11318-02	31-11318-03
	7"/18cm	31-11320-01	31-11320-02	31-11320-03
<b>Spurling</b> 4x10cm	5"/13cm	31-11322-01	31-11322-02	31-11322-03
	6"/15cm	31-11324-01	31-11324-02	31-11324-03
	7"/18cm	31-11326-01	31-11326-02	31-11326-03



	LengthOfShaft			
<b>Cushing</b> 2x10cm	5"/13cm	31-11330-01	31-11330-02	31-11330-03
	6"/15cm	31-11332-01	31-11332-02	31-11332-03
	7"/18cm	31-11334-01	31-11334-02	31-11334-03
<b>Love-Grunwald</b> 3x10cm	5"/13cm	31-11336-01	31-11336-02	31-11336-03
	6"/15cm	31-11338-01	31-11338-02	31-11338-03
	7"/18cm	31-11340-01	31-11340-02	31-11340-03
<b>Spurling</b> 4x10cm	5"/13cm	31-11342-01	31-11342-02	31-11342-03
	6"/15cm	31-11344-01	31-11344-02	31-11344-03
	7"/18cm	31-11346-01	31-11346-02	31-11346-03



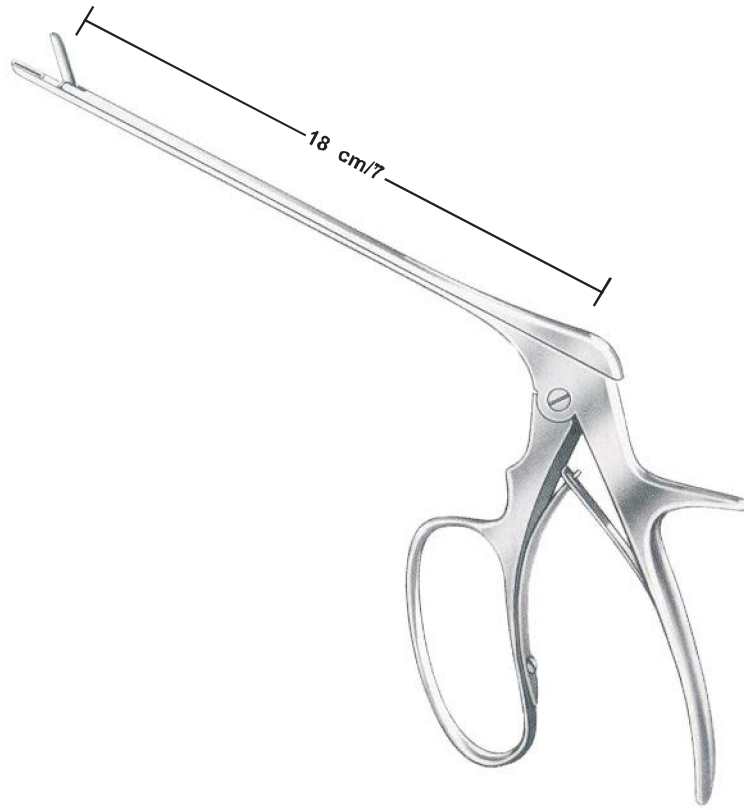

**Ferris-Smith**

WidhOfJaw



2x10mm	31-11350-01	31-11350-02	31-11350-03
3x10mm	31-11352-01	31-11352-02	31-11352-03
4x10mm	31-11354-01	31-11354-02	31-11354-03

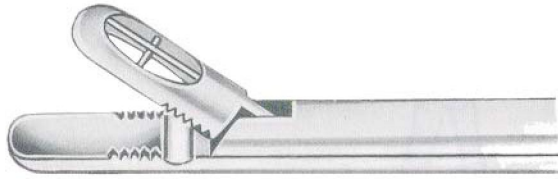

Serrated and Fenestrated Jaws



Bonjour, êtes-vous là maintenant

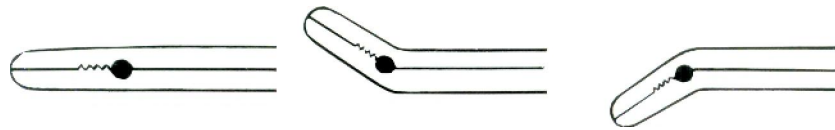

Width Of Jaw	Length Of Shaft			
mm	14cm/5 1/2"	31-11358-01	31-11358-02	31-11358-03
	16cm/6 1/4"	31-11360-01	31-11360-02	31-11360-03
2x12	14cm/5 1/2"	31-11362-01	31-11362-02	31-11362-03
	16cm/6 1/4"	31-11364-01	31-11364-02	31-11364-03
3x12	14cm/5 1/2"	31-11366-01	31-11366-02	31-11366-03
	16cm/6 1/4"	31-11368-01	31-11368-02	31-11368-03
4x14	14cm/5 1/2"	31-11370-01	31-11370-02	31-11370-03
	16cm/6 1/4"	31-11372-01	31-11372-02	31-11372-03
5x14	14cm/5 1/2"	31-11374-01	31-11374-02	31-11374-03
	16cm/6 1/4"	31-11376-01	31-11376-02	31-11376-03
6x16	14cm/5 1/2"			
	16cm/6 1/4"			

Serrated Jaws

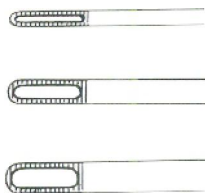

		mm	
31-11378-02	2x10	13cm/5"	
31-11378-03	3x10	13cm/5"	
31-11378-04	4x10	13cm/5"	

Length of Shaft

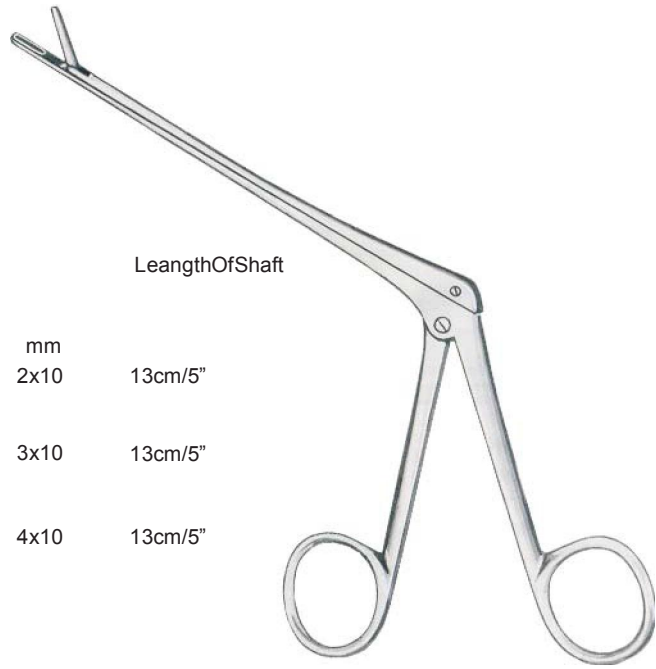

Schlesinger

Grasping Forceps

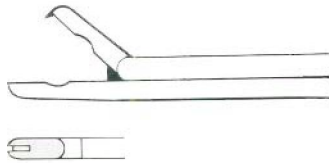

31-11382-16

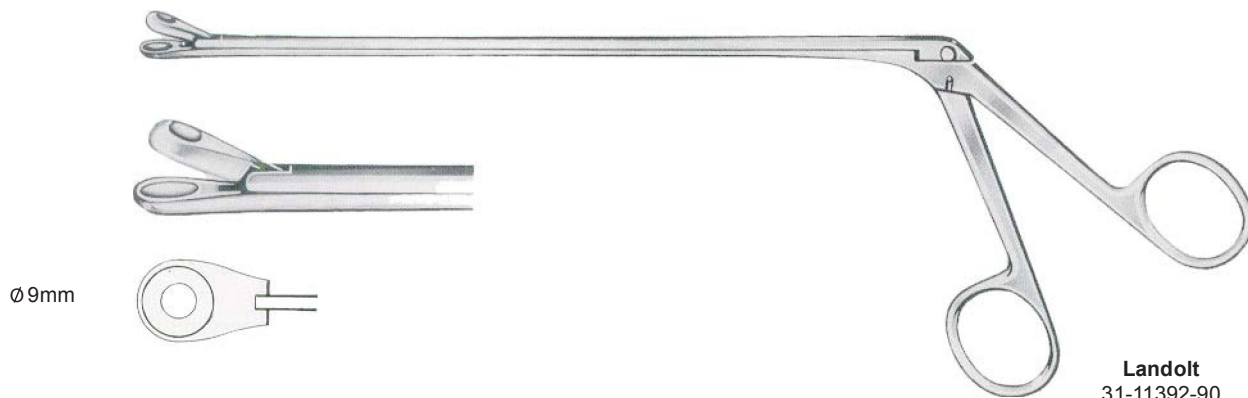
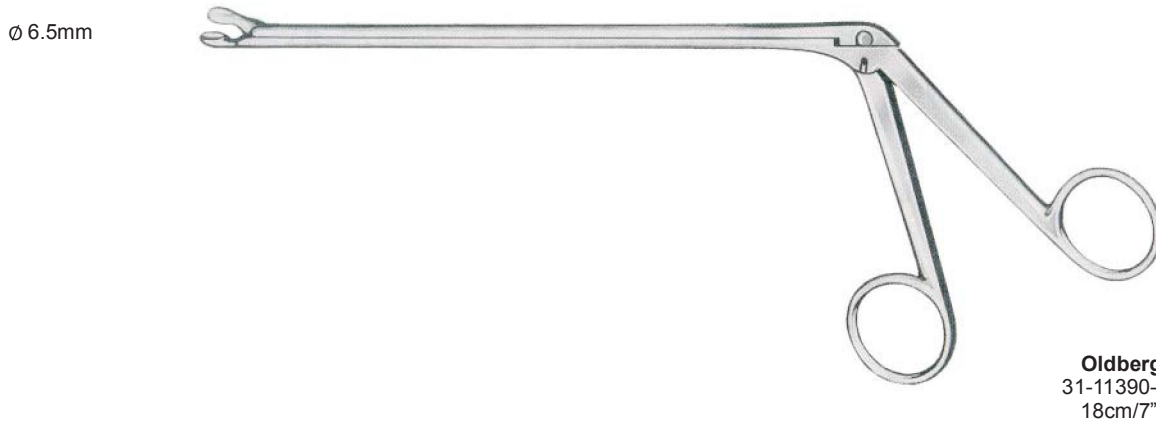
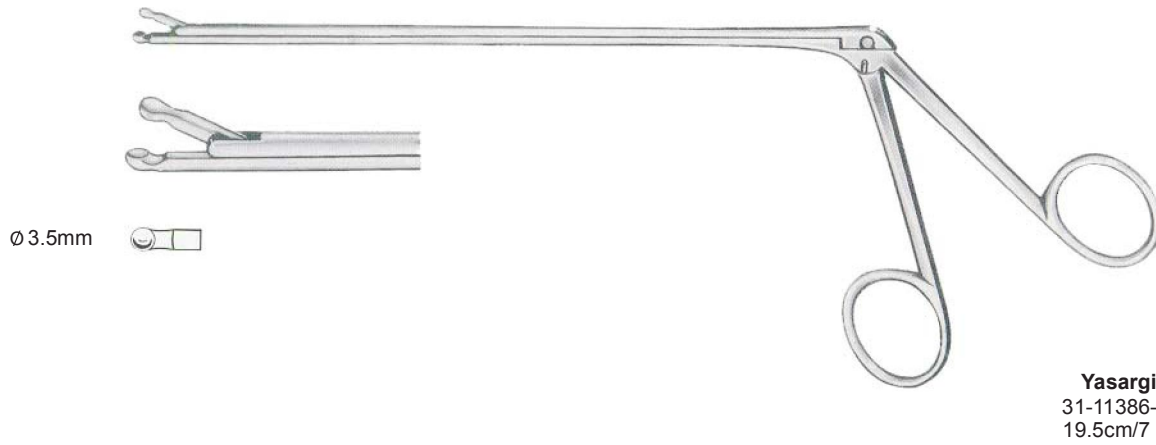

TumorGraspingForcepsBlunt

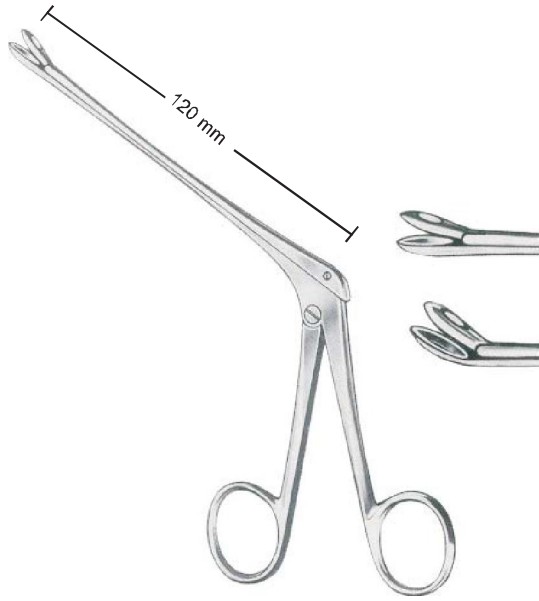

**Weil-Blakesley**

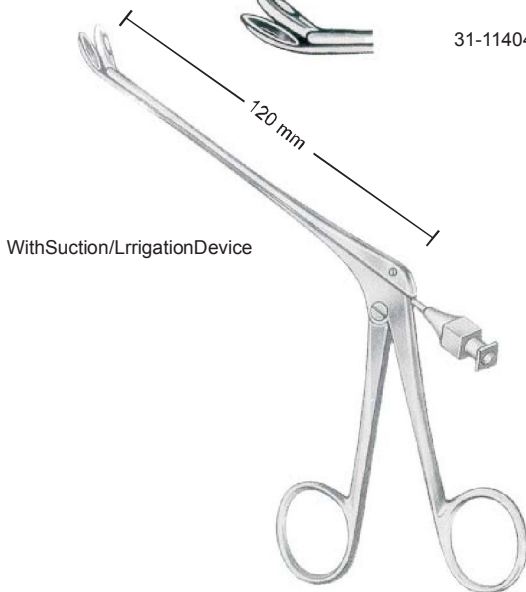

With Suction/Irrigation Device

**Weil-Blakesley**

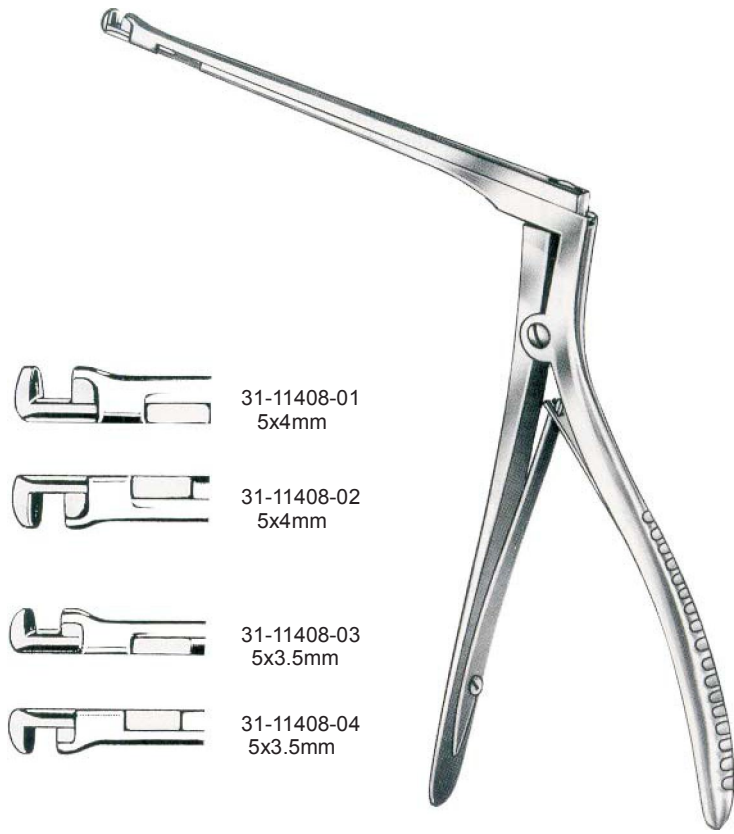

31-11408-01  
5x4mm

31-11408-02  
5x4mm

31-11408-03  
5x3.5mm

31-11408-04  
5x3.5mm

**Hajek  
(Hajek-Kofler)**  
14cm/5 1/2"

360° Turnable

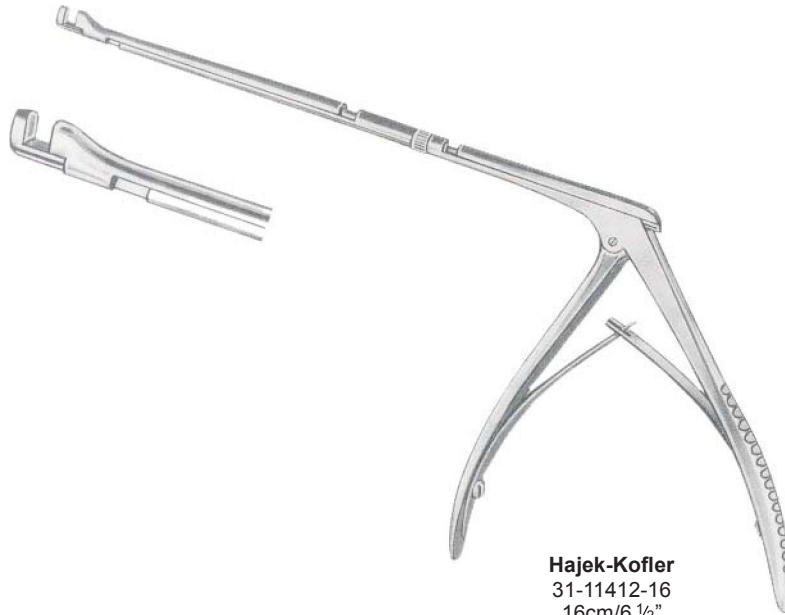

**Hajek-Kofler**  
31-11412-16  
16cm/6 1/2"



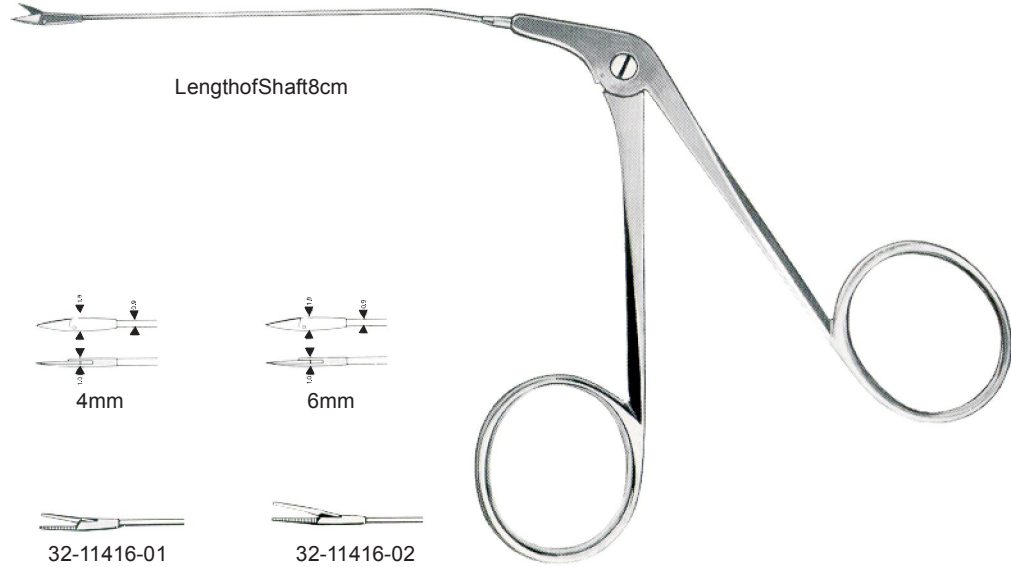

MicroForceps

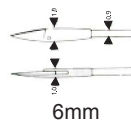
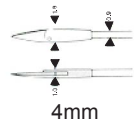

Straight



AngledUp



Straight

32-11418-01  
Ø1mm

OvalCupJaws

32-11418-02

MicroScissors

Straight



AngledUp



CurvedRight



CurvedLeft



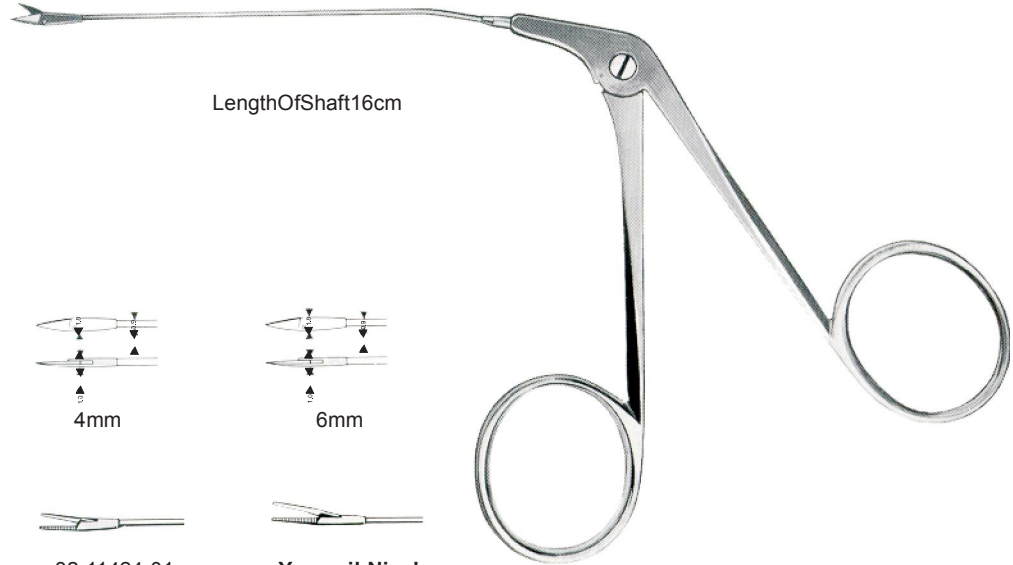

LengthOfShaft16cm

MicroForceps

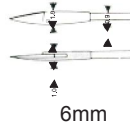
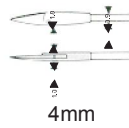

Straight



AngledUp



Cup-ShapedForceps

Straight



OvalCupJaws



MicroForceps

Straight



AngledUp



CurvedRight



CurvedLeft



## MicroScissors

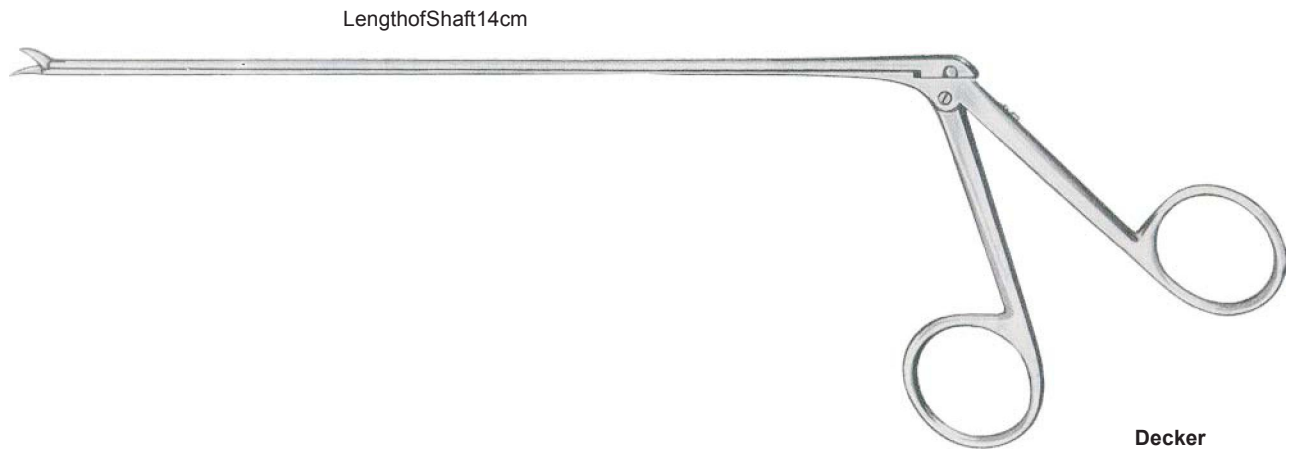

Straight  
32-11430-01



CurvedRight  
32-11430-02



CurvedLeft  
32-11430-03



**Jacobson**  
 32-11432-00  
 18.5cm/7 1/4"



**Koos**  
 32-11432-01  
 18.5cm/7 1/4"



**Koos**  
 32-11432-02  
 18.5cm/7 1/4"



**Koos**  
 32-11432-03  
 18.5cm/7 1/4"



**Koos**  
 32-11432-04  
 18.5cm/7 1/4"



**Koos**  
 32-11434-01  
 18.5cm/7 1/4"

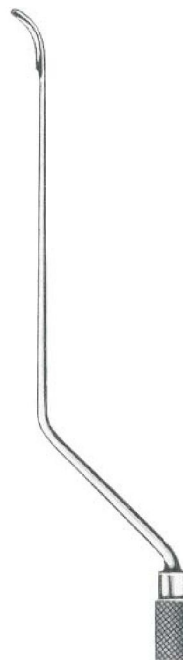

**Koos**  
 32-11434-02  
 18.5cm/7 1/4"



**Yasargil**  
 32-11434-03  
 18.5cm/7 1/4"



**Yasargil**  
 32-11434-04  
 18.5cm/7 1/4"





32-11444-01  
18.5cm/7 1/4"



32-11444-02  
18.5cm/7 1/4"



**Krayenbuhl**  
32-11448-01  
18.5cm/7 1/4"



32-11448-02



32-11448-03



32-11448-04



**Yasargil**  
32-11450-01  
18.5cm/7 1/4"



**Yasargil**  
32-11450-02  
18.5cm/7 1/4"



**Yasargil**  
32-11450-03  
18.5cm/7 1/4"



**Yasargil**  
32-11450-04  
18.5cm/7 1/4"







**Rhoton**  
19cm/7 1/2"



DissectorRound  
32-11470-01  
Ø1mm



DissectorRound  
32-11470-02  
Ø2mm



DissectorRound  
32-11470-03  
Ø3mm



DissectorSpatulaShaped  
32-11470-04  
Ø1mm



DissectorSpatulaShaped  
32-11470-05  
Ø1.5mm



DissectorSpatulaShaped  
32-11470-06  
Ø2.0mm



Elevator  
32-11470-07  
Ø1.2mm



Elevator  
32-11470-08  
Ø2.8mm

je ne sers pas d'abord



NeedleSemi-Sharp  
32-11470-09



HookBlunt  
32-11470-10  
90° 2mm



HookSemi-Sharp  
32-11470-11  
90° 2mm



HookSemi-Sharp  
32-11470-12  
45° 3mm



ProbeAngled  
32-11470-13  
90°



ProbeAngled  
32-11470-14  
1.0x2.0mm



ProbeAngled  
32-11470-15  
1.0x2.0mm  
45°

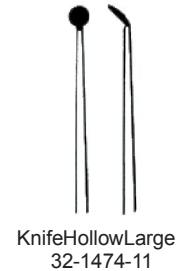
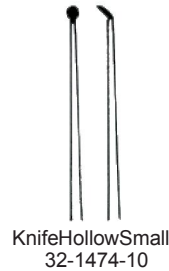
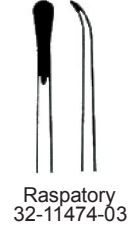
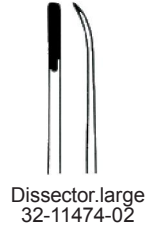
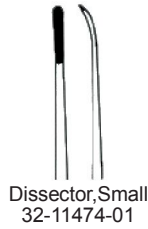



19cm/7 1/2"



MicroDissectors  
32-11478-01  
2mm



32-11478-02  
5mm



32-11478-03  
8mm

NerveHooks



32-11478-04  
3mm



32-11478-05  
5mm

MicroLigatureNeedle



**Samil**  
20cm/8"  
23cm/9"



32-11482-01  
32-11484-01  
1.0x5.0mm

20cm/8"  
23cm/9"



32-11482-02  
32-11484-02  
1.5x5.0mm



32-11482-03  
32-11484-03  
2.0x5.5mm

20cm/8"  
23cm/9"



32-11482-04  
32-11484-04  
2.5x6.0mm



32-11482-05  
32-11484-05  
3.0x7.0mm

20cm/8"  
23cm/9"



32-11482-06  
32-11484-06  
3.5x7.0mm



32-11482-07  
32-11484-07  
4.0x7.5mm

20cm/8"  
23cm/9"



32-11482-08  
32-11484-08  
5.0x8.0mm



WorkingLength  
12.5cm/5"

24cm/9 1/2"

- Angaledup 32-11488-01
- Curveddown 32-11488-02
- Curvedright 32-11488-03
- Curvedleft 32-11488-04

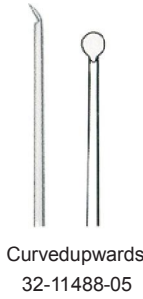

Curvedupwards  
32-11488-05



Angledup  
32-11488-06  
1.0x1.0mm



Angledup  
32-11488-07  
2.5x5mm



Curvedup  
32-11488-08  
1.0x4mm



Curvedup  
32-11488-09  
1.5x5mm



Straight  
32-11488-10  
0.4mm



Curvedup  
32-11488-11  
2.0x6mm



- AngledUp 32-11488-12  
3x5mm
- AngledToRight 32-11488-13  
3x5mm
- AngledToLeft 32-11488-14  
3x5mm



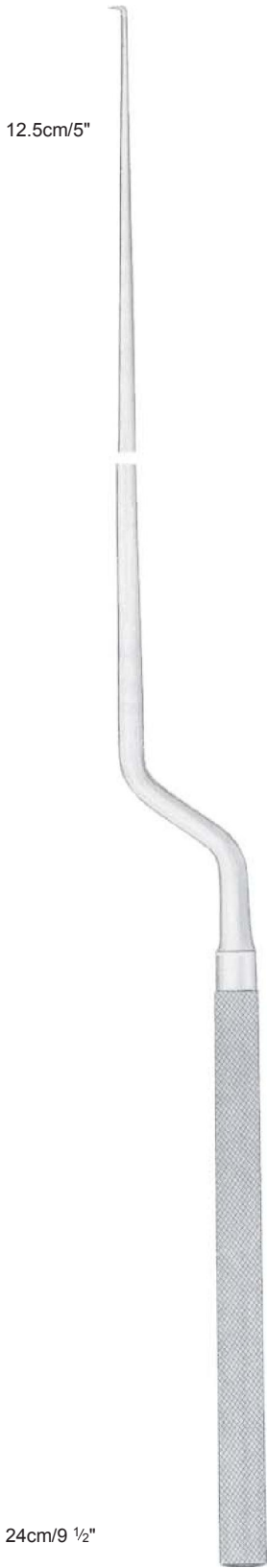

12.5cm/5"

24cm/9 1/2"

AngledUp  
CurvedRight  
CurvedLeft

Blunt  
32-11492-01  
32-11494-01  
32-11496-01  
90° 2mm

Blunt  
32-11492-02  
32-11494-02  
32-11496-02  
90° 2.5mm

Semi-Sharp  
32-11492-03  
32-11494-03  
32-11496-03  
90° 2mm

AngledUp  
CurvedRight  
CurvedLeft

Blunt  
32-11492-04  
32-11494-04  
32-11496-04  
90° 3mm

BallPointed  
32-11492-05  
32-11494-05  
32-11496-05  
90° 3mm

Blunt  
32-11492-06  
32-11494-06  
32-11496-06  
30° 3mm

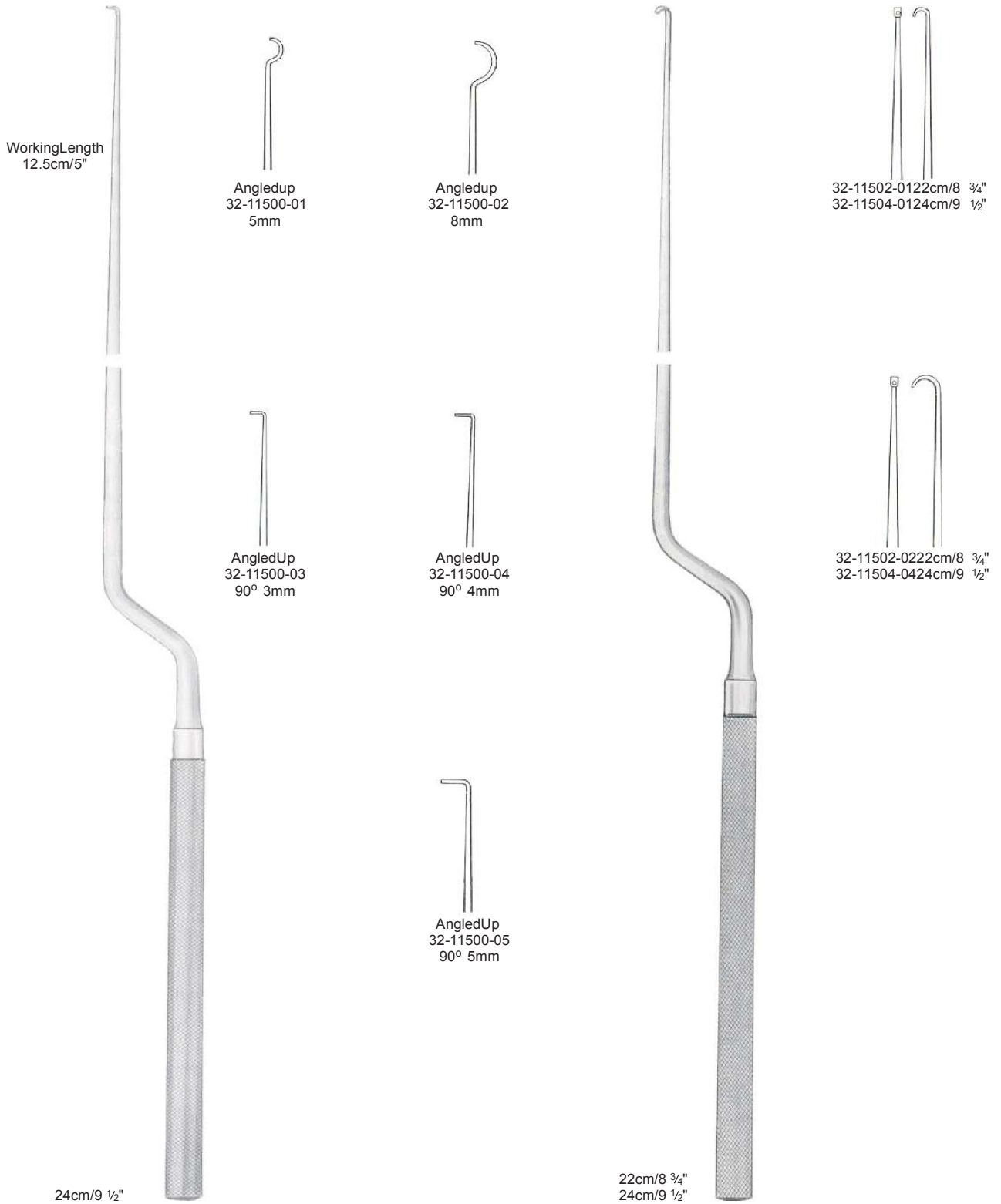

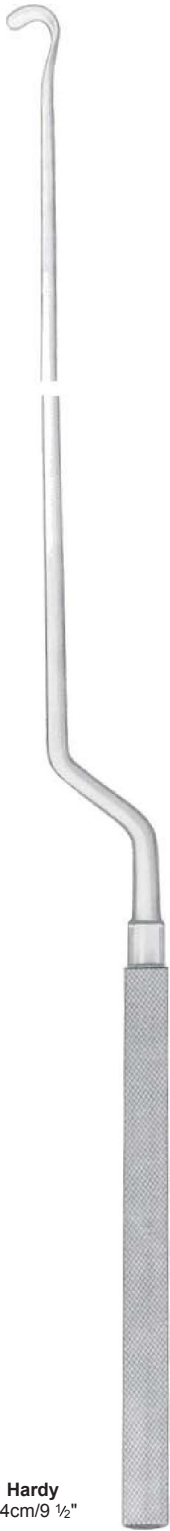

**Hardy**  
24cm/9 1/2"

SickleDissectors



AngledUp 32-11508-01  
 CurvedDown 32-11508-02  
 CurvedRight 32-11508-03  
 CurvedLeft 32-11508-04



**Hardy**

**ImplantFork**  
32-11508-07



AngledUp 32-11508-08  
 CurvedDown 32-11508-09  
 CurvedRight 32-11508-10  
 CurvedLeft 32-11508-11

2mm



**Hardy-Fahlbusch**  
32-11508-05



**Hardy-Fahlbusch**  
32-11508-06

4mm



AngledUp 32-11508-12  
 CurvedDown 32-11508-13



SpatulaDissectors



CurvedUpFlexible  
 32-11512-01  
 8x100mm

CurvedDownFlexible  
 32-11512-02  
 8x100mm



Straight  
 32-11512-03  
 5x20mm



32-11512-06  
 32-11512-07  
 2mm

DissectorsAngled



SharpAngledUp  
 32-11512-04  
 5mm  
 SharpAngledDown  
 32-11512-05







Raspatories

CurvedUp  
 CurvedDown

32-11512-08  
 32-11512-09  
 4mm

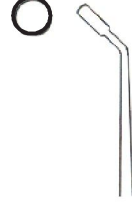

24cm/9 1/2"

Right	Up Down Right Left			
		32-11516-01 32-11518-01 32-11520-01 32-11522-01 Ø2.5mm 90°	32-11516-02 32-11518-02 32-11520-02 32-11522-02 Ø4.0mm 90°	32-11516-03 32-11518-03 32-11520-03 32-11522-03 Ø5.0mm 90°
		32-11516-04 32-11518-04 32-11520-04 32-11522-04 25mm 45°	32-11516-05 32-11518-05 32-11520-05 32-11522-05 40mm 45°	32-11516-06 32-11518-06 32-11520-06 32-11522-06 5mm 45°
	Down			
		32-11516-04 32-11518-04 32-11520-04 32-11522-04 25mm 45°	32-11516-05 32-11518-05 32-11520-05 32-11522-05 40mm 45°	32-11516-06 32-11518-06 32-11520-06 32-11522-06 5mm 45°
		32-11516-04 32-11518-04 32-11520-04 32-11522-04 25mm 45°	32-11516-05 32-11518-05 32-11520-05 32-11522-05 40mm 45°	32-11516-06 32-11518-06 32-11520-06 32-11522-06 5mm 45°



24cm/9 1/2"

Malleable



WithStick

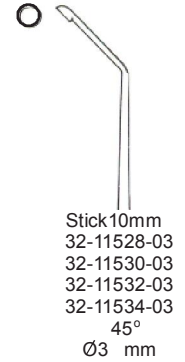









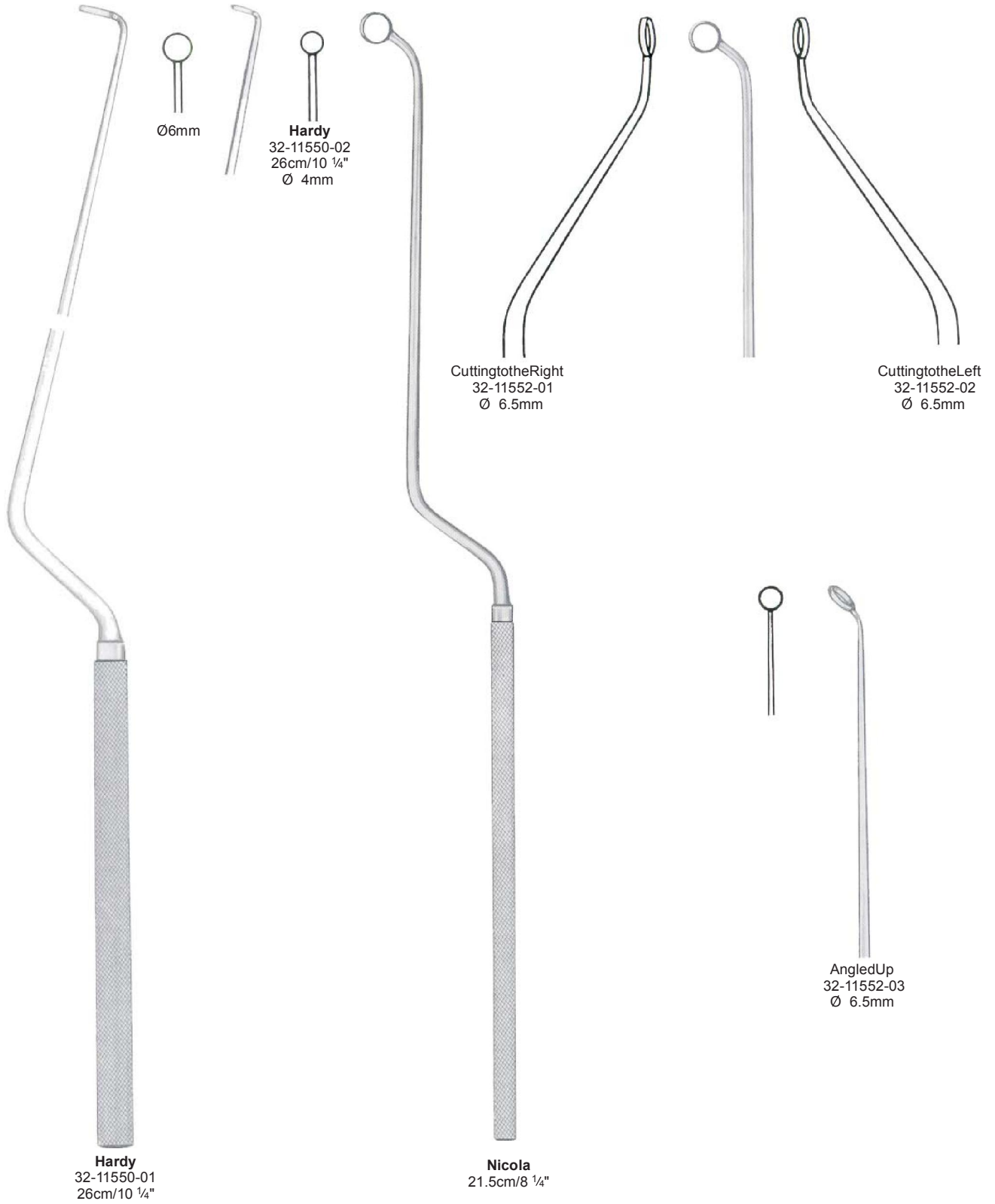



**Nicola**  
32-11556-21  
21.5cm/8 1/4"



26cm/10 1/4"





26cm/10 3/4"



**Landolt-Reulen**  
Dissectorrigid  
32-11562-01  
2mm



**Landolt-Reulen**  
BluntHookrigid  
32-11562-02  
1.7mm



**Fahlbusch**  
Curette malleable  
32-11562-03  
2.5mmO/



**Landolt-Reulen**  
Curette rigid  
32-11562-04  
2.5mmO/



**Fahlbusch**  
Scoop malleable  
32-11562-05



**Landolt-Reulen**  
Raspatories rigid  
32-11562-06  
2.2mm  
3.2mm



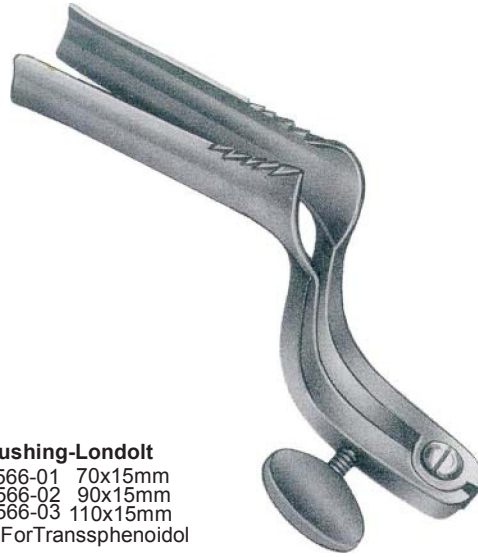

**Cushing-Londolt**  
 32-11566-01 70x15mm  
 32-11566-02 90x15mm  
 32-11566-03 110x15mm  
 SpeculaForTransspenoidol

Mirrors



32-11570-06  
6mm



32-11570-08  
8mm



32-11570-10  
10mm



32-11570-12  
12mm



**Mirrorhandle**  
32-11570-00

∅=InsideDia



**Troltsch**  
ForBabies

Fig. 133-11574-011.5mmO /  
Fig. 233-11574-022.5mmO /  
Fig. 333-11574-033.5mmO /

33-11574-30  
Setof 3



**Troltsch**  
ForAdults

Fig. 433-11574-044.0mmO /  
Fig. 533-11574-055.0mmO /  
Fig. 633-11574-066.0mmO /  
Fig. 733-11574-077.0mmO /

33-11574-30 33-11574-40  
Setof 3 Setof 4  
Fig4-6 Fig4-7



**Poltzer**

Fig. 133-11578-012.0mmO /  
Fig. 233-11578-023.0mmO /  
Fig. 333-11578-034.0mmO /

33-12278-30  
Setof 3  
Fig1-3



**Erhard**  
ForAdults

Fig. 133-11582-013.0mmO /  
Fig. 233-11582-024.0mmO /  
Fig. 333-11582-035.0mmO /  
Fig. 433-11582-046.0mmO /

33-11582-30 33-11582-40  
Setof3 Setof4  
Fig.1-3 Fig.1-4



**Hartmann**  
ForBabies

Fig. 133-11586-012.0mmO /



**Hartmann**  
ForChildren

Fig. 233-11586-023.0mmO /  
Fig. 333-11586-034.0mmO /  
Fig. 433-11586-045.5mmO /

33-11586-30  
Setof3  
Fig.2-4



**Hartmann**  
ForAdults

Fig. 333-11590-034.0mmO /  
Fig. 433-11590-045.5mmO /  
Fig. 533-11590-056.5mmO /  
Fig. 633-11590-067.5mmO /

33-11590-30 33-11590-40  
Setof3 Setof4  
Fig.4-6 Fig.3-6



**Toynbee**  
ForAdults

Fig. 133-11594-014.5mmO /  
Fig. 233-11594-025.5mmO /  
Fig. 333-11594-036.5mmO /  
Fig. 433-11594-047.5mmO /

33-11594-30 33-11594-40  
Setof3 Setof4  
Fig.2-4 Fig.1-4

AluBlack



33-11598-60  
Setof6  
Fig.1-6



Ø=InsideDia  
Fig. 133-11598-01 4.5x5.5mmO /  
Fig. 233-11598-02 5.5x6.5mmO /  
Fig. 333-11598-03 6.5x7.5mmO /  
Fig. 433-11598-04 7.5x8.5mmO /  
Fig. 533-11598-05 8.5x9.5mmO /  
Fig. 633-11598-06 9.5x10.5mmO /



**Gruber**  
33-11602-30 Setof 3 Fig. 2-4  
33-11602-40 Setof 4 Fig. 1-4  
33-11604-40 Setof 3 Fig. 2-4  
33-11604-40 Setof 4 Fig. 1-4

Fig. 133-11602-01 2.8x3.8mmO / Fig. 133-11604-01 4.5mmO/  
Fig. 233-11602-02 3.8x4.8mmO / Fig. 233-11604-02 5.0mmO/  
Fig. 333-11602-03 5.0x6.2mmO / Fig. 333-11604-03 5.5mmO/  
Fig. 433-11602-04 6.0x7.2mmO / Fig. 433-11604-04 6.0mmO/

Black



**Hartmann**  
33-11608-40  
Setof4  
Fig.1-4

Fig. 133-11608-01 3.0mmO/  
Fig. 233-11608-02 4.0mmO/  
Fig. 333-11608-03 5.0mmO/  
Fig. 433-11608-04 7.0mmO/

Black



Fig. 533-11608-05 9.0mmO/  
Fig. 633-11608-06 11.0mmO/

**Hartmann**  
33-11608-20  
Setof2  
Fig.5-6

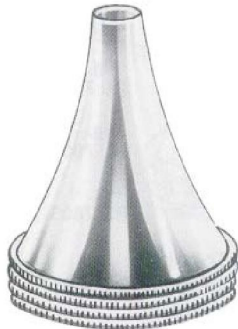

33-11612-40  
Setof4  
Fig.3-6  
**Boucheron**

33-11612-033.5mmO /  
33-11612-044.5mmO /  
33-11612-055.5mmO /  
33-11612-066.5mmO /



33-11618-01



33-11618-02



33-11618-03

Fig.1 33-11618-01 4.2x3.8mm  
Fig.2 33-11618-02 5.5x3.8mm  
Fig.3 33-11618-03 6.5x3.8mm  
33-11618-30  
Setof3  
Fig.1-3



33-11620-01



33-11620-02



33-11620-03

Fig.1 33-11620-014.2mm  
 Fig.2 33-11620-025.5mm  
 Fig.3 33-11620-036.5mm  
 33-11620-30  
 Setof3  
 Fig.1-3

Metalsupportsfor specula

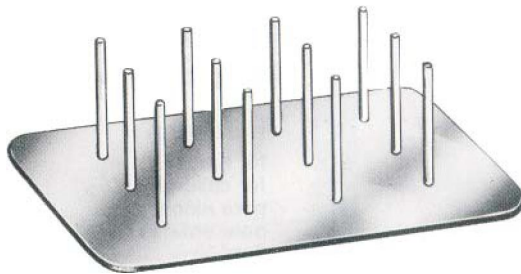

For12Specula  
 33-11624-00



**Richnau-Holmgren**  
 33-11628-022.0mm Ø  
 33-11628-044.0mm Ø  
 33-11628-066.0mm Ø

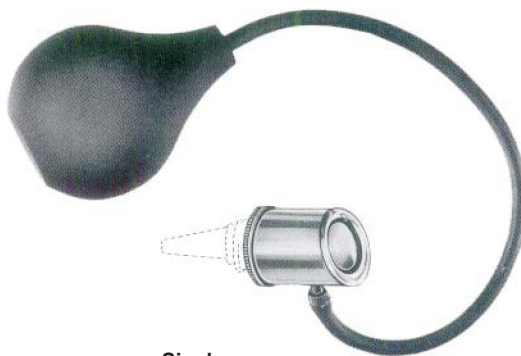

Siegle



6.5mm



7mm



8mm

Otoscopewith3earspeculaandrubbertubewithbulb  
 33-11632-00



### Tuning Forks

Hartmann

Lucae

French  
Hartmann

Lucae  
C128

Hartmann  
C128

C <sub>2</sub>	16			33-11644-16
C <sub>2</sub>	32			33-11644-32
C	64			33-11645-01
C	128	33-11636-00	33-11640-00	33-11645-02
C <sub>1</sub>	256	33-11636-01	33-11640-01	33-11645-03
C <sub>2</sub>	512	33-11636-02	33-11640-02	
C <sub>3</sub>	1024	33-11636-03	33-11640-03	
C <sub>4</sub>	2048	33-11636-04	33-11640-04	
C <sub>5</sub>	4096	33-11636-05	33-11640-05	

Variableuptoh(Engl.B)

33-11648-00

33-11652-00



**Rydel-Seiffer**  
33-11656-00  
C64/C128

WithClamps =C64  
WithoutClamps =C128

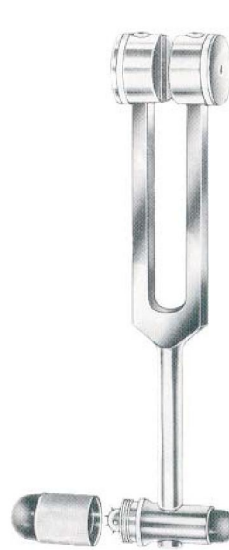

Tuning Fork for neurological examination, with percussion hammer, pin wheel, brush and needle

33-11660-00



33-11664-01  
C64



33-11664-02  
C128

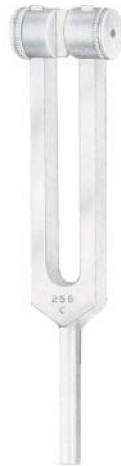

33-11664-03  
C256



33-11664-04  
C512



33-11664-05  
C1024



33-11664-06  
C2048



33-11664-07  
C4096



Hartmann

- 33-11668-20  
2.0mm Ø
- 33-11668-25  
2.5mm Ø
- 33-11668-30  
3.0mm Ø
- 33-11668-40  
4.0mm Ø
- 33-11668-50  
5.0mm Ø



Itard

- 33-11672-30  
3mm Ø
- 33-11672-35  
3.5mm Ø
- 33-11672-40  
4mm Ø
- 33-11672-45  
4.5mm Ø
- 33-11672-50  
5mm Ø

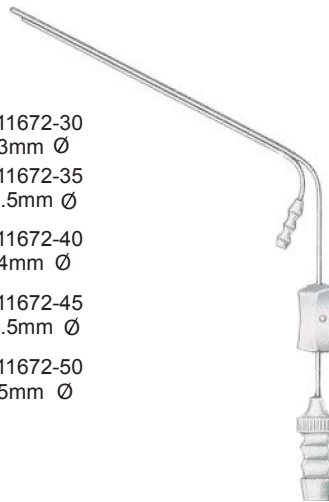

- 33-11676-09 0.9mm Ø
- 33-11676-12 1.2mm Ø
- 33-11676-15 1.5mm Ø



- Baron(Schuknecht)**
- 33-11680-01 1.0x75mm Ø
  - 33-11680-02 1.5x75mm Ø
  - 33-11680-03 2.0x75mm Ø





**Krause**  
33-11684-16  
16cm/6 1/4"



**Krause-Voss**  
33-11688-16  
16cm/6 1/4"



**Lange-Wilde**  
33-11692-16  
16cm/6 1/4"



Package of 1 dozen each

	mm	Ø
33-11700-02	0.2	
33-11700-03	0.3	

*Ear Dressing Forceps*



**Troeltsch (Wilde)**



**Troeltsch**



**Lucae**



**Lucae**



**Jansen**

Cm	In	Troeltsch (Wilde)	Troeltsch	Lucae	Lucae	Jansen
11.0	4 1/4"	33-11704-11				
12.0	4 3/4"	33-11704-12	33-11706-12		33-11712-14	
14.0	5 1/2"	33-11704-14		33-11710-14		
15.0	6"	33-11704-15				
16.0	6 1/4"					33-11716-16
18.0	7"					33-11716-18
20.0	8"					33-11716-20



**Okonogto**  
33-11720-16  
16cm/6 ¼"



**Littauer**  
33-11724-12  
12cm/4 ¾"



FinePattern

**Hartmann**  
33-11726-12  
12cm/4 ¾"



**Hartmann**  
33-11728-14  
14cm/5 ½"

StandardPattern

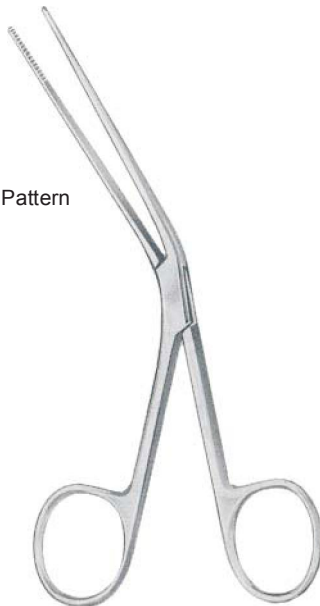

**Tilley**  
33-11732-14  
33-11732-16  
14cm/5 ½"



**Buck**  
33-11736-09  
9cm/3 ½"



33-11740-08  
8cm/3 ¼"

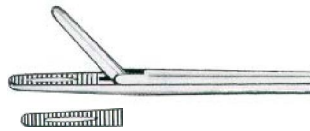

**Hartmann-Noyes**  
33-11744-09  
8.5cm/3 1/4"

1:2

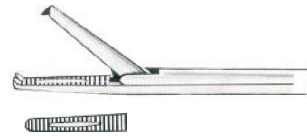

**Hartmann-Noyes**  
33-11746-09  
8.5cm/3 1/4"



**Hartmann**  
33-11750-09 8.5cm/3 1/4"  
33-11750-14 14cm/5 1/2"  
33-11750-16 16cm/6 1/4"

1:2



**Hartmann**  
33-11752-09 8.5cm/3 1/4"  
33-11752-14 14.0cm/5 1/2"



**Hartmann**  
33-11756-208.5cm/3 1/4" ○ 2.0mm  
33-11756-258.5cm/3 1/4" ○ 2.5mm  
33-11756-308.5cm/3 1/4" ○ 3.0mm



**Hartmann-Citelli**  
33-11760-02 ○ 2mm 8.5cm/3 1/4"  
33-11760-03 ○ 3mm 8.5cm/3 1/4"



**Strumpel**  
33-11762-09  
8.5cm/3 1/4"



**Hartamm-Weingartner**  
33-11766-09  
8.5cm/3 1/4"



**Hartamm**  
33-11770-09  
8.5cm/3 1/4"















**Hartamm-Wullstein**  
33-11774-06 8.5cm/3 1/4" 08x6mm  
33-11774-08 8.5cm/3 1/4" 1.8x8mm



**Hartamm-Wullstein**  
33-11778-01 ○ 1mm 8.5cm/3 1/4"  
33-11778-02 ○ 2mm 8.5cm/3 1/4"



LengthofShaft8cm

	MicroForceps	Mini	Cup-ShapedForceps
	1.6x7.0mm  33-11782-01	0.7x3.5mm  33-11782-08	0.9x1.1mm  33-11782-11
	 33-11782-02 0.8x4.0mm		
SmoothJaw	 33-11782-03 0.8x6.0mm		
CurvedLeft	 33-11782-04 0.8x6.0mm		 33-11782-12 0.9x1.1mm
CurvedRight	 33-11782-05 0.8x4.0mm		 33-11782-13 0.9x1.1mm
AngledUp	 33-11782-06 0.8x4.0mm		 33-11782-14 0.9x1.1mm
AngledDown	 33-11782-07 0.8x4.0mm		 33-11782-15 0.9x1.1mm

MicroForceps



**Greven**  
33-11782-16  
0.8x5.0mm



**Cos**  
33-11782-18  
0.8x3.0mm

LeftAngled



**Juers**  
33-11782-19  
0.8x6.0mm



**Hough**  
33-11782-21  
0.8x3.0mm

RightAngled



**Juers**  
33-11782-20  
0.8x6.0mm



**Hough**  
33-11782-22  
0.8x3.0mm



**Fuller**  
33-11782-23  
0.8x6.0mm



**Tabb**  
33-11782-24

UpwardCutting



**Dieter**  
33-11782-30

DownwardCutting



**Dieter**  
33-11782-31

CuttingtotheRight



**Dieter**  
33-11782-32

Cuttingtotheleft



33-11782-33

MicroScissors



**Bellucci**  
33-11786-01  
4.0mm



**Bellucci**  
33-11786-02  
5.5mm

AngledUp



**Bellucci**  
33-11786-03  
5.5mm

CurvedLeft



**Bellucci**  
33-11786-04  
5.5mm

CurvedRight



**Bellucci**  
33-11786-05  
5.5mm

CurvedLeft



**Shea**  
33-11786-07  
7.0mm

CurvedRight



**Shea**  
33-11786-08  
7.0mm



LengthofShaft8cm

MicroForceps

0.5mm

SmoothJaw

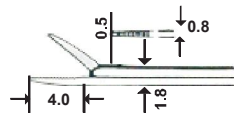

Straight

33-11790-01

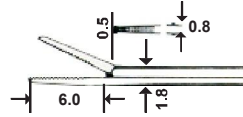

33-11790-02

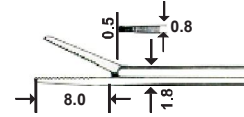

33-11790-03

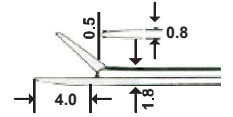

33-11790-04

CurvedRight  
CurvedLeft  
AngledUp  
AngledDown

33-11794-01  
33-11794-02  
33-11794-03  
33-11794-04

MicroForceps

0.3mm

SmoothJaw

Straight

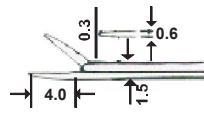

33-11800-01

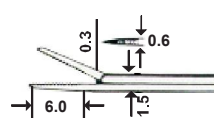

33-11800-02

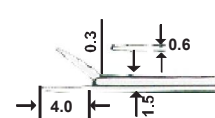

33-11800-03



Length of Shaft 8cm

Cup-Shaped Forceps



Micro Scissors



**Bellucci**  
0.8mm

1.5x0.8mm

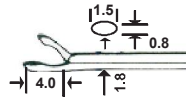

- |              |             |
|--------------|-------------|
| Straight     | 33-11804-01 |
| Curved Right | 33-11804-02 |
| Curved Left  | 33-11804-03 |
| Angled Up    | 33-11804-04 |
| Angled Down  | 33-11804-05 |

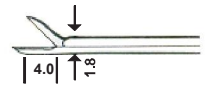

- |             |
|-------------|
| 33-11806-01 |
| 33-11806-02 |
| 33-11806-03 |
| 33-11806-04 |
| 33-11806-05 |

1.0x0.5mm

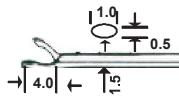

Straight

33-11804-06

LengthofShaft8cm



CruraForceps



OpentoRight

**Fisch**  
33-11810-01



OpentoLeft

**Fisch**  
33-11810-02

LengthofShaft8cm



WireClosureForceps



**McGee**  
33-11814-01



**McGee/Fisch**  
33-11814-02

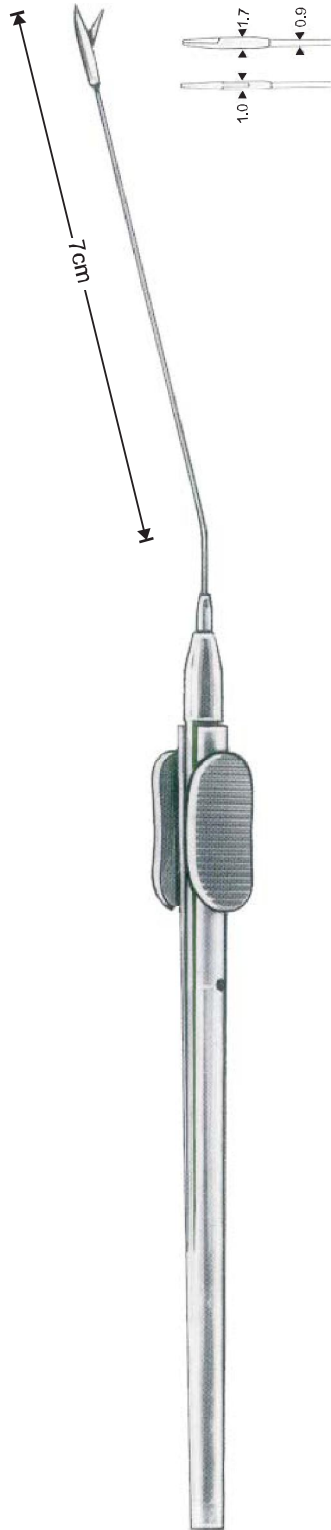

33-11818-01



33-11818-02

MicroScissors



33-11820-01



33-11820-02

MicroForceps



33-11822-01



33-11822-02

Cup-ShapedForceps



**Overholt**  
21-07166-29  
29.5cm/11 1/2"



**Overholt**  
21-07168-29  
29.5cm/11 1/2"



**Overholt**  
21-07170-28  
28.5cm/11 1/4"



**Hyllin**  
21-07174-03  
14.5cm/5 3/4"



21-07174-01



21-07174-02



21-07174-03



**Matson**  
21-07178-22  
22cm/8 3/4"

## NeedlesAndHooks



**Barbara**  
33-11842-01



33-11842-02



33-11842-03



**Rosen**  
33-11842-04



**Barbara**



25°  
33-11844-03 0.3mm  
33-11844-06 0.6mm  
33-11844-10 1.0mm



45°  
33-11846-03 0.3mm  
33-11846-06 0.6mm  
33-11846-10 1.0mm  
33-11846-12 1.2mm  
33-11846-15 1.5mm  
33-11846-20 2.0mm  
33-11846-25 2.5mm



90°  
33-11848-03 0.3mm  
33-11848-06 0.6mm  
33-11848-10 1.0mm  
33-11848-12 1.2mm  
33-11848-15 1.5mm  
33-11848-20 2.0mm  
33-11848-25 2.5mm



33-11850-050.5mm  
33-11850-101.0mm

## NeedlesAndHooks



90°  
 33-11852-03 0.3mm  
 33-11852-06 0.6mm  
 33-11852-10 1.0mm

90°  
 33-11854-03 0.3mm  
 33-11854-06 0.6mm  
 33-11854-10 1.0mm

**McGee**  
 33-11856-05 0.5mm  
 33-11856-10 1.0mm

**McGee**  
 33-11858-05 0.5mm  
 33-11858-10 1.0mm



25°  
 33-11862-030.3mm  
 33-11862-060.6mm  
 33-11862-101.0mm

**Barbara**  
 33-11860-01

**Rosen**  
 33-11860-02

25°  
 33-11864-030.3mm  
 33-11864-060.6mm  
 33-11864-101.0mm

45°  
 33-11868-030.3mm  
 33-11868-060.6mm  
 33-11868-101.0mm

45°  
 33-11870-030.3mm  
 33-11870-060.6mm  
 33-11870-101.0mm



Dissectors, Measuring Rod, Elevators, Curettes and Mobilizer

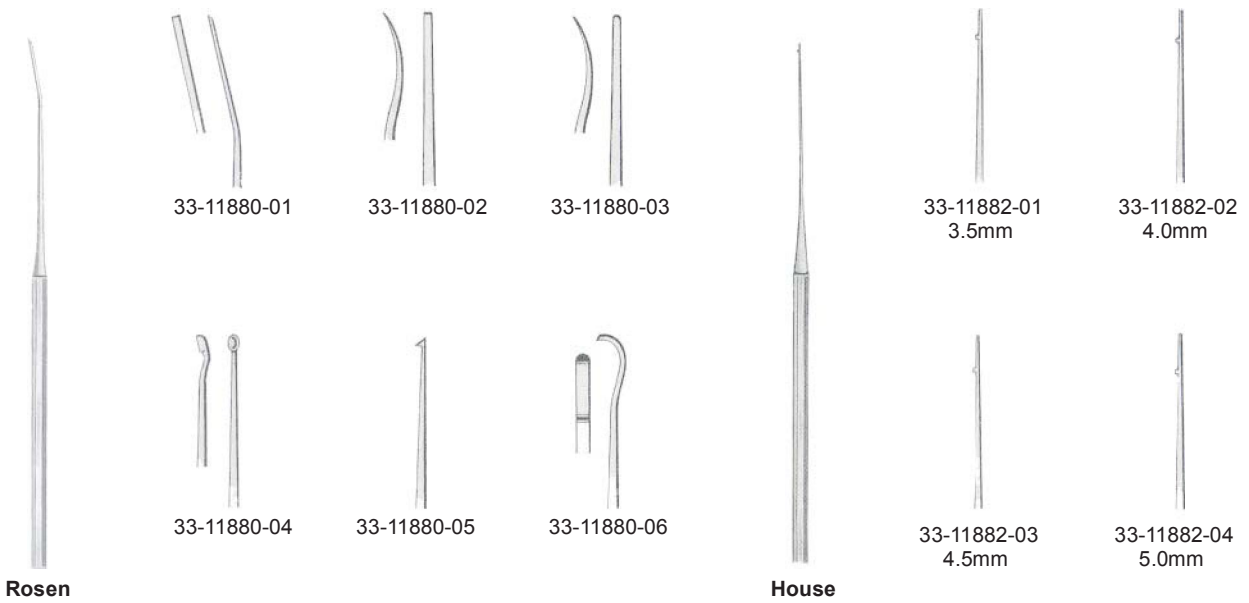



**Buckingham**



33-11886-01



33-11886-02



33-11886-03



**House**

33-11890-101.0/1.2mm  
33-11890-151.5/1.8mm



**House**

33-11892-101.0/1.2mm  
33-11892-151.5/1.8mm



**Shea**

33-11896-151.5mm



33-11900-01

33-11900-02

33-11900-03

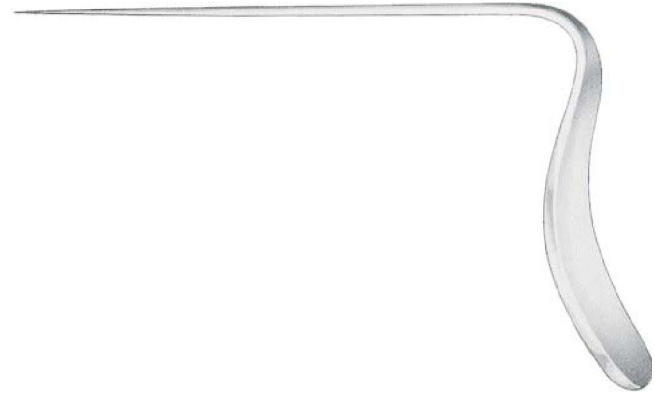

Zollner



33-11900-04

33-11900-05

33-11900-06

33-11900-07

33-11900-08

33-11900-09

33-11900-10

33-11900-11



33-11900-12

33-11900-13

33-11900-14



33-11900-15

33-11900-16

33-11900-17



33-11900-18

33-11900-19

33-11900-20

33-11900-21

33-11900-22

33-11900-23

33-11900-24



WidthofBite

**Citelli**  
33-11904-202.0mm  
33-11904-303.0mm



WidthofBite



**Citelli-Beyer**  
33-11906-151.5mm  
33-11906-202.0mm



WidthofBite







**Brunings**  
33-11910-40  
33-11910-60

-  33-11912-30 3.0mm
-  33-11912-40 4.0mm
-  33-11912-50 5.0mm
-  33-11912-60 6.0mm



**Kerrison**  
20cm/8"



	Fig.000								
Blunt	33-11914-30	00	0	1	2	3	4	5	
		33-11914-20	33-11914-10	33-11914-01	33-11914-02	33-11914-03	33-11914-04	33-11914-05	
Sharp	33-11915-30	33-11915-20	33-11915-10	33-11915-01	33-11915-02	33-11915-03	33-11915-04	33-11915-05	
									
Blunt	33-11916-30	33-11916-20	33-11916-10	33-11916-01	33-11916-02	33-11916-03	33-11916-04	33-11916-05	
									
Sharp	33-11917-30	33-11917-20	33-11917-10	33-11917-01	33-11917-02	33-11917-03	33-11917-04	33-11917-05	
									



**Langenbeck**  
33-11920-13  
13cm/5 1/8"



**Shapleigh**  
13cm/5 1/8"



33-11924-01

33-11924-02



**Jansen**  
33-11928-15  
15cm/6"



**Barth**  
33-11932-18  
18cm/7"



**Billeau**  
16.5cm/6 1/2"

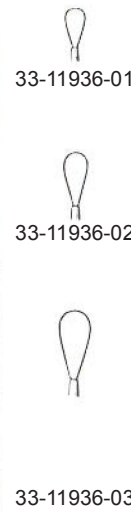

33-11936-01

33-11936-02

33-11936-03



16cm/6 1/4"  
**Snellen**



33-11940-01



33-11940-02



**Gross**  
33-11944-12  
12cm/4 3/4"



**Zaufal**  
33-11948-16  
16cm/6 1/4"



**Hartmann**  
33-11952-16  
16cm/6 1/4"



**Lucae**  
14cm/5 1/2"

33-11956-01

33-11956-02

33-11956-03



**Wagener**  
14cm/5 1/2"

33-11960-01

33-11960-02

33-11960-03

33-11960-04

33-11960-05

33-11960-06



**Day**  
16cm/6 1/4"

33-11964-01

33-11964-02



**Muck**  
33-11968-13  
13.5cm/5 1/8"



**Poltzer**  
33-11972-16  
16cm/6 1/4"



Fig. Straight  
1 33-11976-01  
2 33-11976-02  
3 33-11976-03



**Sexton**



Curved  
33-11980-01  
33-11980-02  
33-11980-03



**Gerzog-Sexton**  
33-11984-17  
17cm/6 1/2"



Messer



**Politzer**  
33-11988-17  
17cm/6 3/4"



**Lempert**  
33-11992-15  
15cm/6"



**Lempert**  
15cm/6"



33-11996-01



33-11996-02



**Lempert**  
33-12000-01  
15cm/6"



**Lempert**  
33-12000-02  
15cm/6"

Knives

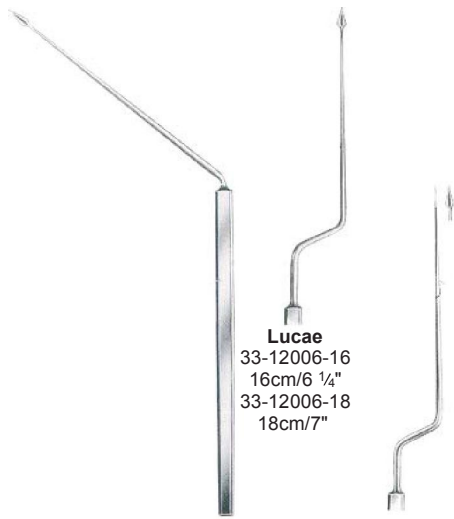

**Lucae**  
33-12006-16  
16cm/6 1/4"  
33-12006-18  
18cm/7"

**Politzer**  
33-12004-16  
16.5cm/6 1/2"

**Lucae**  
33-12008-18  
18cm/7"



**Politzer**  
33-12012-17  
17cm/6 3/4"



Ear Operating Set

**Sprague**  
33-12014-19  
19cm/7 1/2"



33-12018-10



33-12018-20



33-12018-30

Ear Syringe, Complete With 2 Cannulas and 1 Protecting Disk

- 33-12018-02 50ml
- 33-12018-03 75ml
- 33-12018-04 100ml
- 33-12018-06 150ml
- 33-12018-08 200ml



**Fraenkel**  
34-12022-01 Fig.1  
34-12022-02 Fig.2  
34-12022-03 Fig.3



34-12026-01  
34-12026-02  
34-12026-03  
13cm/5"



Fig.1  
34-12026-01  
34-12028-01

Fig.2  
34-12026-02  
34-12028-02

Fig.3  
34-12026-03  
34-12028-03



34-12028-01  
34-12028-02  
34-12028-03  
13cm/5"



**Hartmann**  
15cm/6"

34-12030-01



Fig.1

34-12032-01

34-12030-02

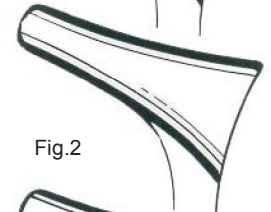

Fig.2

34-12032-02

34-12030-03

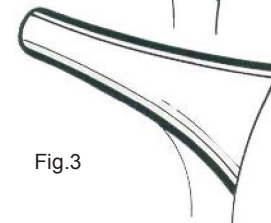

Fig.3

34-12032-03



**Hartmann**  
15cm/6"



34-12036-01



Fig. 1



Fig. 2

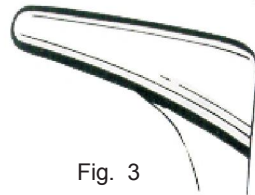

Fig. 3

34-12038-01



34-12038-02

34-12038-03

**Hartmann-Halle**  
15cm/6"

**Hartmann-Halle**  
15cm/6"



34-12042-01



34-12044-01



34-12044-02

34-12042-02



**Tieck**  
13.5cm/5 1/4"



**Beckmann**  
15cm/6"



Fig. 1  
34-12048-01



Fig. 2  
34-12048-02

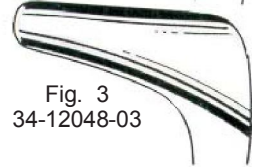

Fig. 3  
34-12048-03



**Mod.Wien**

34-12052-01



Fig.1

34-12052-02

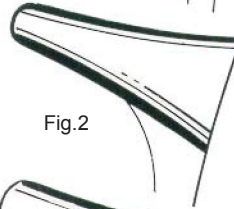

Fig.2

34-12052-03

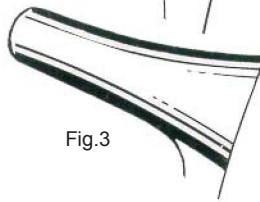

Fig.3

34-12054-01



**Wien**

34-12054-02

34-12054-03



**Killian**



Fig.1  
34-12058-01  
35mm

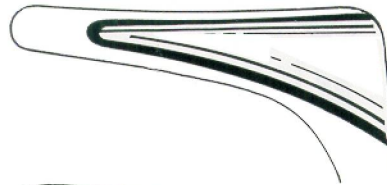

Fig.2  
34-12058-02  
50mm

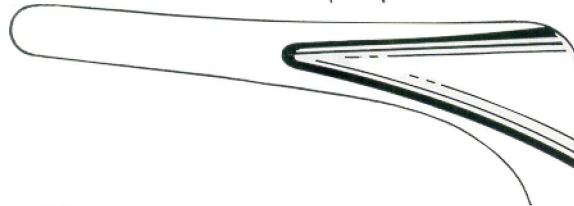

Fig.3  
34-12058-03  
75mm

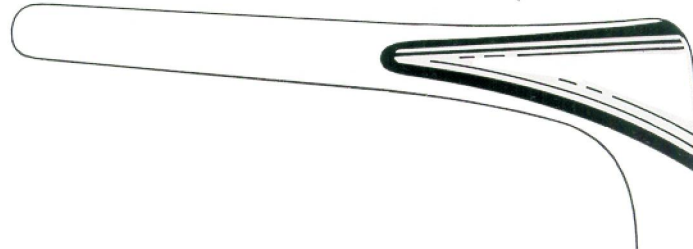

Fig.4  
34-12058-04  
90mm



**Cottle**  
34-12062-01  
34-12062-02  
34-12062-03  
34-12062-04  
15cm/6"

**Cottle**  
34-12064-01  
34-12064-02  
34-12064-03  
34-12064-04  
15cm/6"

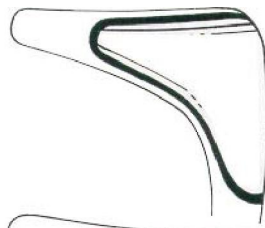

Fig1  
34-12062-01  
34-12064-01  
35mm

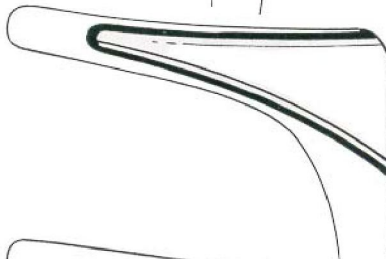

Fig2  
34-12062-02  
34-12064-02  
50mm

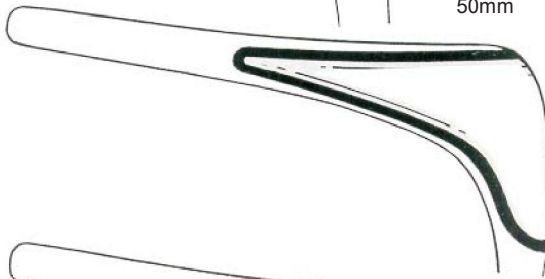

Fig3  
34-12062-03  
34-12064-03  
75mm

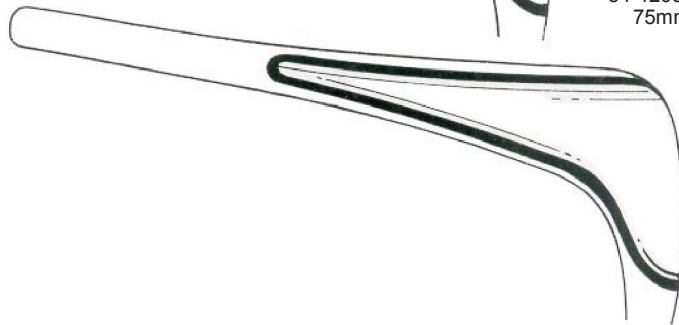

Fig4  
34-12062-04  
34-12064-04  
90mm



34-12068-30 Fig.1-3  
34-12068-40 Fig.1-4  
34-12068-70 Fig.1-7



34-12068-01    34-12068-02    34-12068-03    34-12068-04



34-12068-05    34-12068-06    34-12068-07





**Krause**  
34-12074-26  
26cm/10 1/4"



**Krause-Voss**  
34-12076-26  
26cm/10 1/4"



**Lange-Wilde**  
34-12078-24  
24cm/9 1/2"



Package Of 1 Dozen Each  
34-12080-10  
0.3mm



Cm	In	Troeltsch (Wilde)
15.0	6	34-12084-15
18.0	7	34-12084-18
20.0	8	



Cm	In	Gruenwald (Jansen)
15.0	6	34-12088-16
18.0	7	34-12088-18
20.0	8	34-12088-20



**Westmacott (West)**  
34-12092-20  
20cm/8"

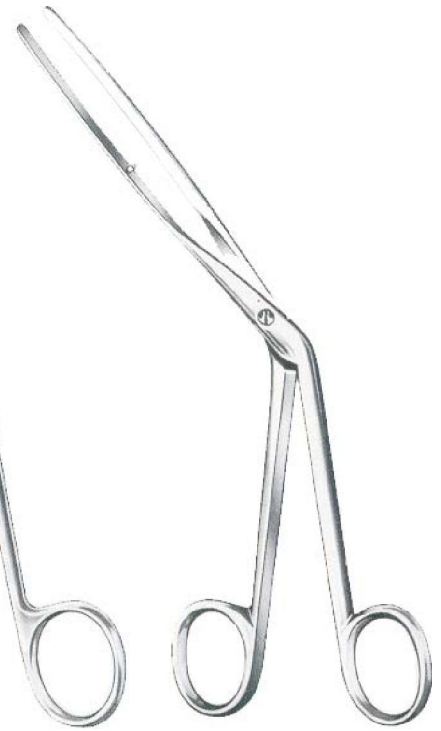

**Lubet-Barbon**  
34-12096-20  
20cm/8"



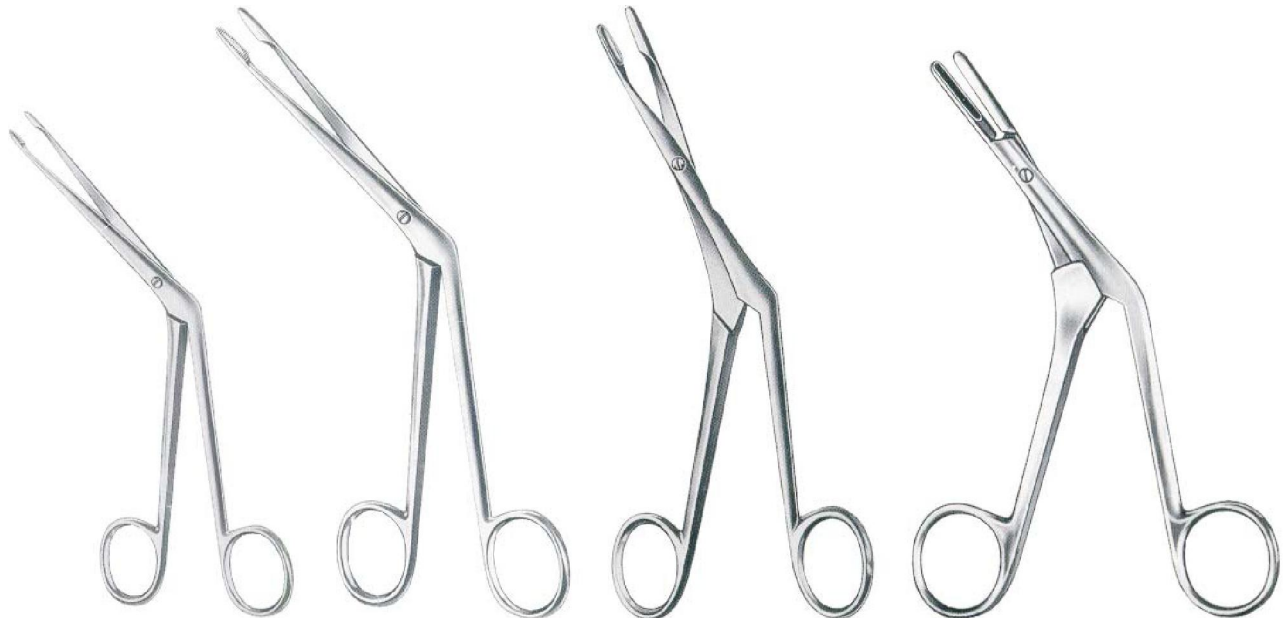

**Hartmann**  
34-13000-16  
16cm/6 1/4"

**Hartmann**  
34-13002-20  
20cm/8"

**Heymann**  
34-13006-18  
18cm/7"

**Craig**  
34-13010-18  
18cm/7"

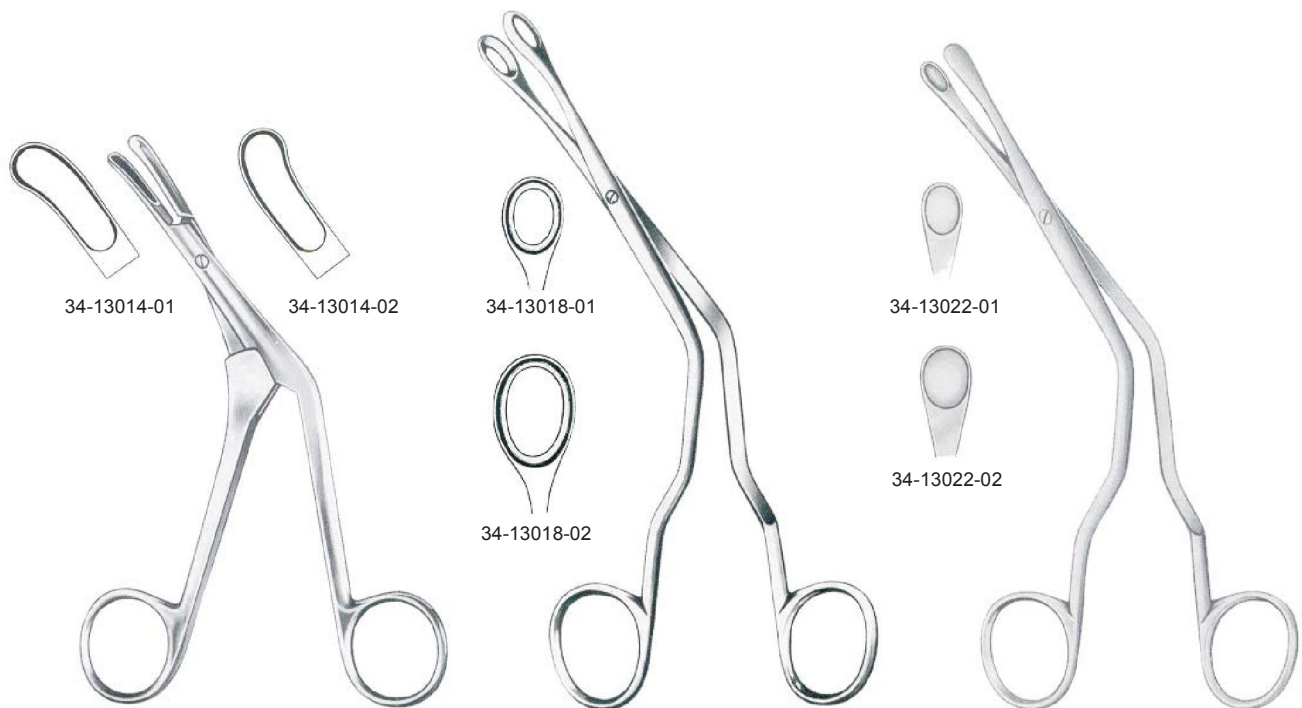

34-13014-01

34-13014-02

34-13018-01

34-13022-01

34-13018-02

34-13022-02

**CraigDomnick**  
18cm/7"

**Luc**  
20cm/8"

**Luc**  
20cm/8"



**Bruenings**  
19cm/7 1/2"



**Takahashi**  
19cm/7 1/2"



**Watson-Williams**  
19cm/7 1/2"



**Ferris-Smith**  
34-13038-12  
19cm/7 1/2"

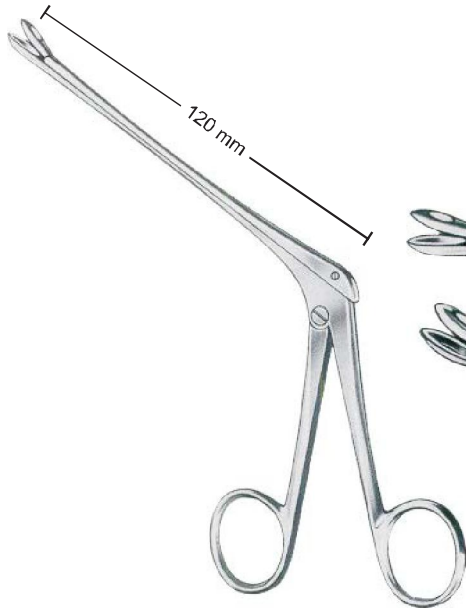

**Weil-Blakesley**



**Struycken**



34-13048-01



34-13048-02



**Grunwald**

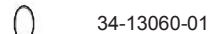

34-13060-01



34-13060-02



34-13060-03



**Grunwald**



34-13062-01

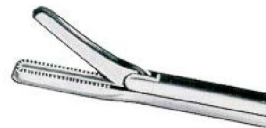

**Hajek**



34-13052-01  
2.2mm



34-13052-02  
2.6mm



34-13052-03  
3.0mm

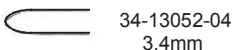

34-13052-04  
3.4mm



**Hartmann**

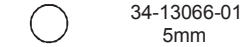

34-13066-01  
5mm



34-13066-02  
7mm



34-13066-03  
9mm

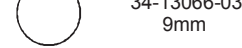

34-13066-04  
11mm



34-13066-04  
11mm



**Myles**

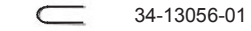

34-13056-01

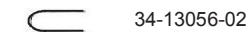

34-13056-02



34-13056-03



**Schmeden**



34-13070-01



34-13070-02

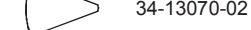

34-13070-03



34-13070-03

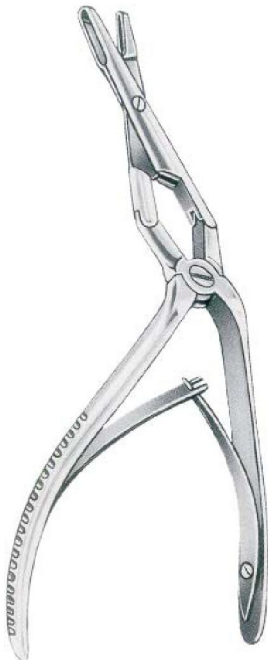

**Middleton-Jansen**  
34-13074-19  
19cm/7 1/2"

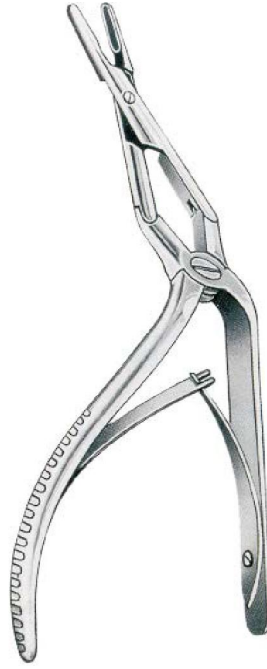

**Middleton-Jansen**  
34-13076-19  
19cm/7 1/2"



**Kazanjan**  
34-13080-18  
18cm/7"



**Caplan**  
34-13084-20  
20cm/8"



34-13088-01  
5x4mm



34-13088-02  
5x4mm



34-13088-03  
5x3.5mm



34-13088-04  
5x3.5mm

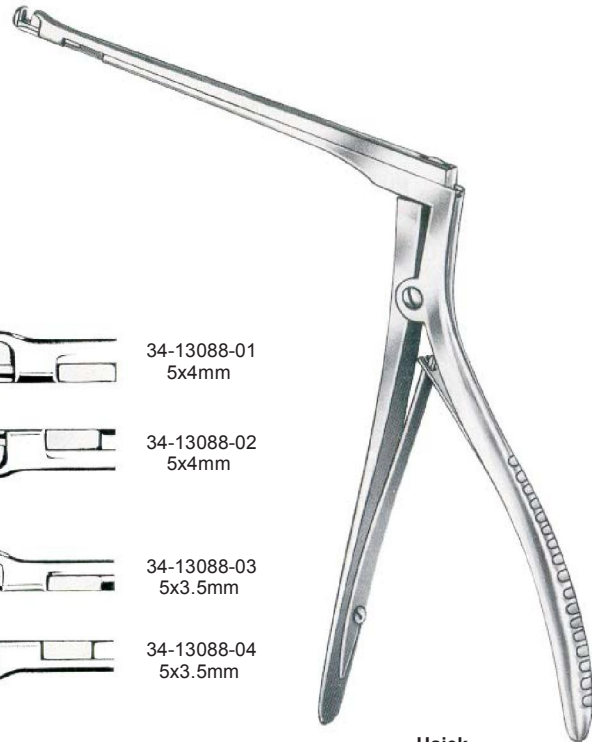



**Hajek  
(Hajek-Kofler)  
Shaft**  
14cm/5 1/2"



Ferris-Smith-Kerrison



Ferris-Smith-Kerrison

		Width of Bite		Length of Shaft			Width of Bite		Length of Shaft		
		15cm/6"	20cm/8"	20cm/8"	18cm/7"	18cm/7"	15cm/6"	20cm/8"	18cm/7"	18cm/7"	
Cutting Upward		34-13092-03	3mm	34-13098-03	34-13104-03	1mm	34-13108-03	34-13114-03	34-13120-01		
		34-13092-05	5mm	34-13098-05	34-13104-05	2mm			34-13120-02		
Cutting Upward 40°		34-13094-03	3mm	34-13100-03		3mm	34-13110-03	34-13116-03	34-13120-03		
		34-13094-05	5mm	34-13100-05		4mm			34-13120-04		
Cutting Downward		34-13096-03	3mm	34-13102-03	34-13106-03	5mm	34-13112-03	34-13118-03	34-13120-05		
		34-13096-05	5mm	34-13102-05	34-13106-05	1mm			34-13122-01		
						2mm			34-13122-02		
						3mm			34-13122-03		
						4mm			34-13122-04		
						5mm			34-13122-05		
									34-13124-01		
									34-13124-02		
									34-13124-03		
									34-13124-04		
									34-13124-05		



360° Turnable

**Hajek-Kofler**  
34-13128-16  
16cm/6 1/2"



- 34-13132-03  
3mm
- 34-13132-04  
4mm
- 34-13132-05  
5mm
- 34-13132-06  
6mm

**Kerrison**  
20cm/8"



**Jurasz**  
22cm/8 3/4"



34-13136-01



34-13136-02



34-13136-03

## Rhinoplastic and Nasal Knives



**Joseph**  
Pointed

← Straight  
34-13140-01



Curved  
34-13141-01



**Joseph**  
Blunt

← Straight  
34-13144-01



Curved  
34-13145-01



**Converse**  
34-13149-15  
15cm/6"



**Joseph**  
34-13152-14  
14cm/5 1/2"





**Cottle**  
34-13156-15  
15cm/6"



**Cottle**  
34-13158-14  
14cm/5 1/2"



**Freer**  
34-13162-16  
16cm/6 1/4"



**Joseph**  
34-13166-16  
16.5cm/6 1/2"



**Maltz**  
34-13170-16  
16.5cm/6 1/2"



**Freer**  
34-13174-19  
19cm/7 1/2"

SeptumKnives



**Ballenger**  
20cm/8"



34-13178-03 3mm 34-13179-03  
34-13178-04 4mm 34-13179-04  
34-13178-05 5mm 34-13179-05



**Ballenger**  
20cm/8"



**Bruenings**  
34-13182-16  
16cm/6 1/4"



34-13186-044mm  
34-13186-055mm

**McKenty**  
15cm/6"



**Halle**  
34-13190-16  
16.5cm/6 1/2"



**Joseph**  
34-13194-16  
16.5cm/6 1/2"



**Cottle**  
34-13198-19  
19.5cm/7 1/2"



Blunt



Sharp

**Freer**  
34-13202-19  
19cm/7 1/2"

**Freer**  
34-13203-19  
19cm/7 1/2"



**Freer**  
34-13206-18  
18cm/7"

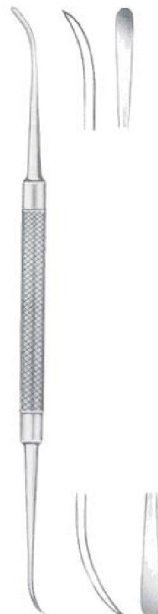

**Freer-Yasargil**  
34-13208-18  
18.5cm/7 1/4"



**Howarth**  
34-13212-21  
21.5cm/8 1/2"



**McKenty**  
34-13216-22  
22cm/8 3/4"



**Killian**  
34-13220-18  
18.5cm/7 1/4"



**Cottle**  
34-13224-23  
23cm/9"



**Killian**  
34-13228-18  
18.5cm/7 1/4"



**Pierce**  
34-13232-21  
21cm/8 1/4"



**Pennington**  
34-13236-21  
21cm/8 1/4"

Raspatories



34-13240-18  
18cm/7"



**Joseph(Cottle)  
Masing**  
34-13244-22  
22cm/8 3/4"



**Masing**  
34-13248-20  
20.5cm/8 3/8"



**Joseph**  
34-13252-16  
16cm/6 1/4"

Periost-Elevators

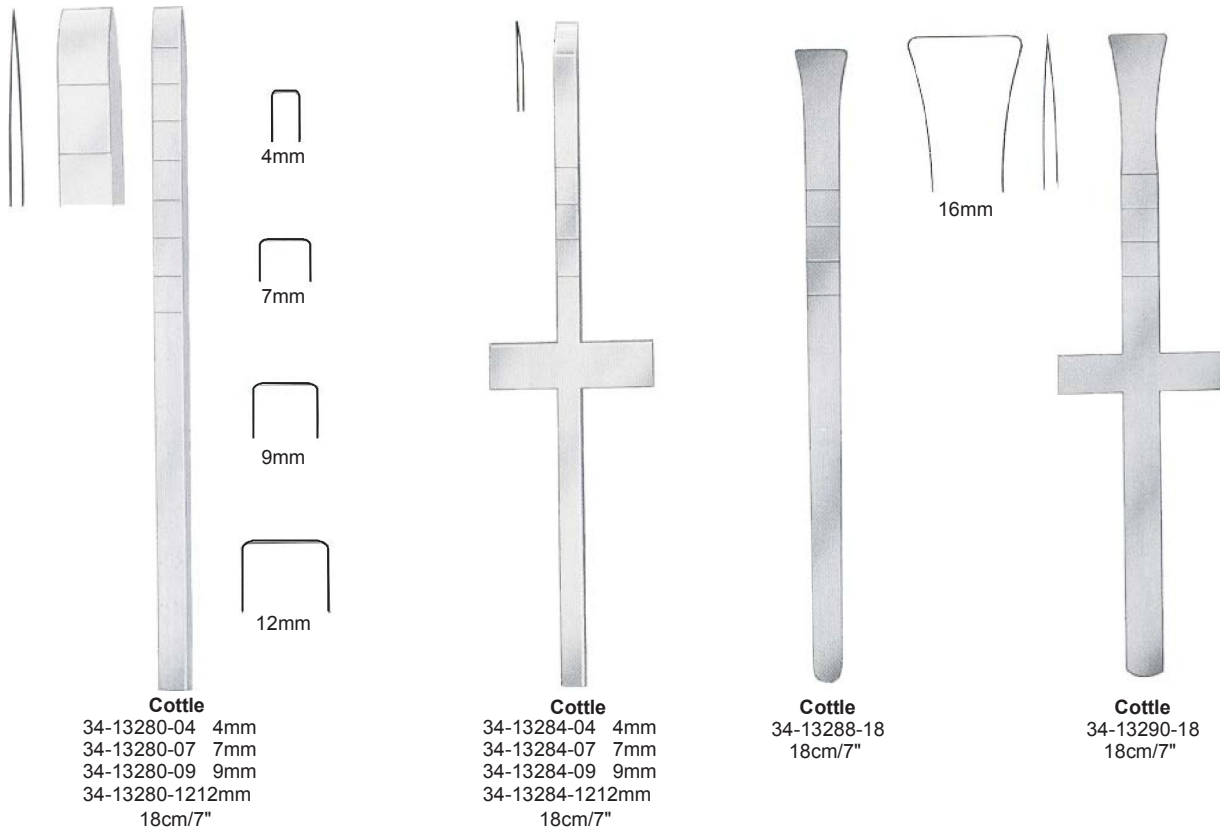
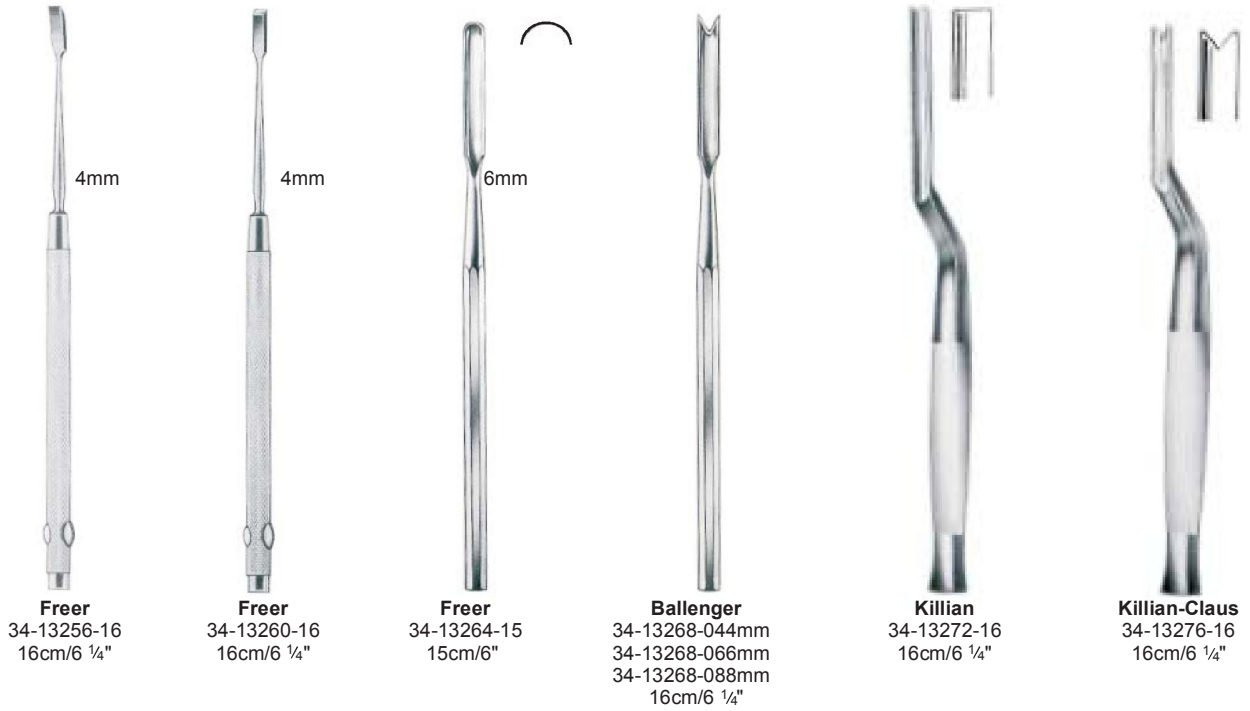



34-13294-08  
16cm/6 1/4"  
8mm



**Cottle**  
34-13298-04 4mm  
34-13298-07 7mm  
34-13298-09 9mm  
34-13298-12 12mm  
34-13298-18 18mm



**Cottle Curved**  
34-13299-06  
18cm/7"  
6mm



**Fomon**  
34-13302-055mm  
34-13302-088mm  
17cm/6 3/4"



**Walter**  
34-13306-033mm  
34-13306-044mm  
18cm/7"



**(Silver) Masing**  
34-13310-01 34-13310-02 34-13310-03  
17.5cm/7 7/8"



**Cinelli**  
34-13314-1010mm  
34-13314-1212mm  
34-13314-1414mm  
34-13314-1616mm  
16cm/6 1/4"

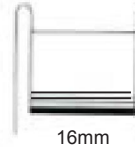
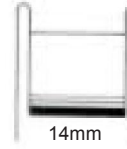

**Masing**  
34-13318-17  
17.5cm/6 7/8"



**west**  
34-13322-16  
16cm/6 1/4"



**West**  
34-13324-16  
16cm/6 1/4"

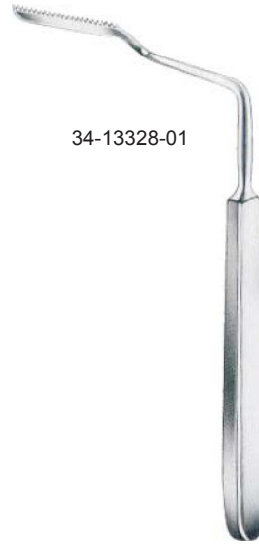

34-13328-01

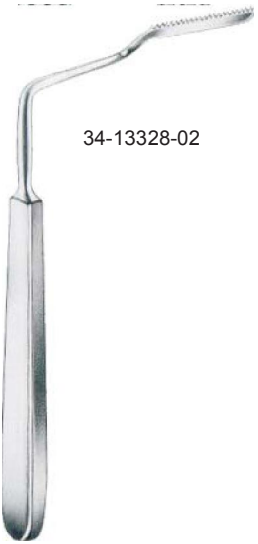

34-13328-02

**Joseph**  
17cm/6 3/4"



**Joseph**  
34-13330-01  
17cm/6 3/4"



**Joseph**  
34-13332-02  
17cm/6 3/4"



**Joseph**  
34-13332-03  
17cm/6 3/4"



## PinsmedTc

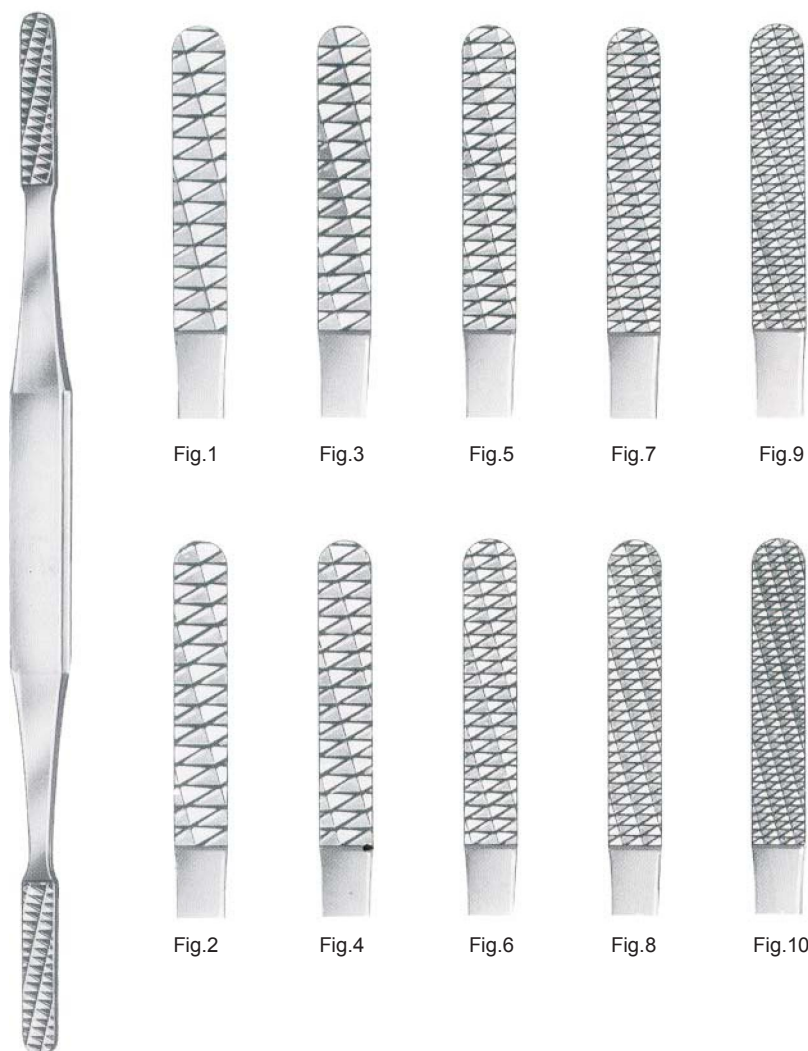

Fig.1

Fig.3

Fig.5

Fig.7

Fig.9

Fig.2

Fig.4

Fig.6

Fig.8

Fig.10

### Fomon

- Fig.1/2 34-13336-12
  - Fig.3/4 34-13336-34
  - Fig.5/6 34-13336-56
  - Fig.7/8 34-13336-78
  - Fig.9/1034-13336-90
- 21cm/8 1/4"

## PinsmedTc



### Parkes

- |                   |             |                   |             |
|-------------------|-------------|-------------------|-------------|
| Fig.1             | 34-13340-01 | Fig.1             | 34-13344-01 |
| Fig.2             | 34-13340-02 | Fig.2             | 34-13344-02 |
| Fig.3             | 34-13340-03 | Fig.3             | 34-13344-03 |
| Fig.4             | 34-13340-04 | Fig.4             | 34-13344-04 |
| Fig.5             | 34-13340-05 | Fig.5             | 34-13344-05 |
| Fig.6             | 34-13340-06 | Fig.6             | 34-13344-06 |
| Fig.7             | 34-13340-07 | Fig.7             | 34-13344-07 |
| Fig.8             | 34-13340-08 | Fig.8             | 34-13344-08 |
| Fig.9             | 34-13340-09 | Fig.9             | 34-13344-09 |
| Fig.1034-13340-10 |             | Fig.1034-13344-10 |             |
- 20.5cm/8 1/8"      17cm/6 3/4"

### Maltz



**Maltz**  
17cm/6 3/4"

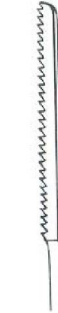

34-13348-01



34-13348-02

**PinsmedTC**



**Miller**  
16cm/6 1/4"



34-13352-01



34-13352-02

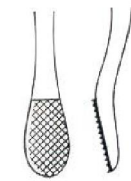

19cm/7 1/2"



34-13356-02



34-13356-03



34-13356-04



34-13356-05



34-13356-06



34-13356-07



**Aufricht**  
34-13360-17  
17.5cm/6 7/8"



**Fomon**  
34-13364-21  
21cm/8 1/4"



**Maltz**  
34-13368-18  
18cm/7"



**Joseph**  
16cm/6 1/4"

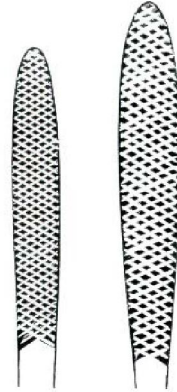

34-13372-01 34-13372-02



**Lewis**  
18cm/7"



Fine  
34-13376-01



Coarse  
34-13376-02



**Cottle**  
34-13380-21  
21cm/8 1/4"

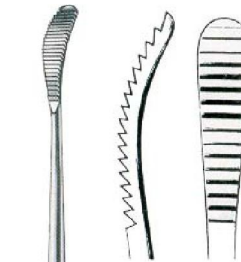

34-13384-01



34-13384-02

**Aufricht**  
21cm/8 1/4"

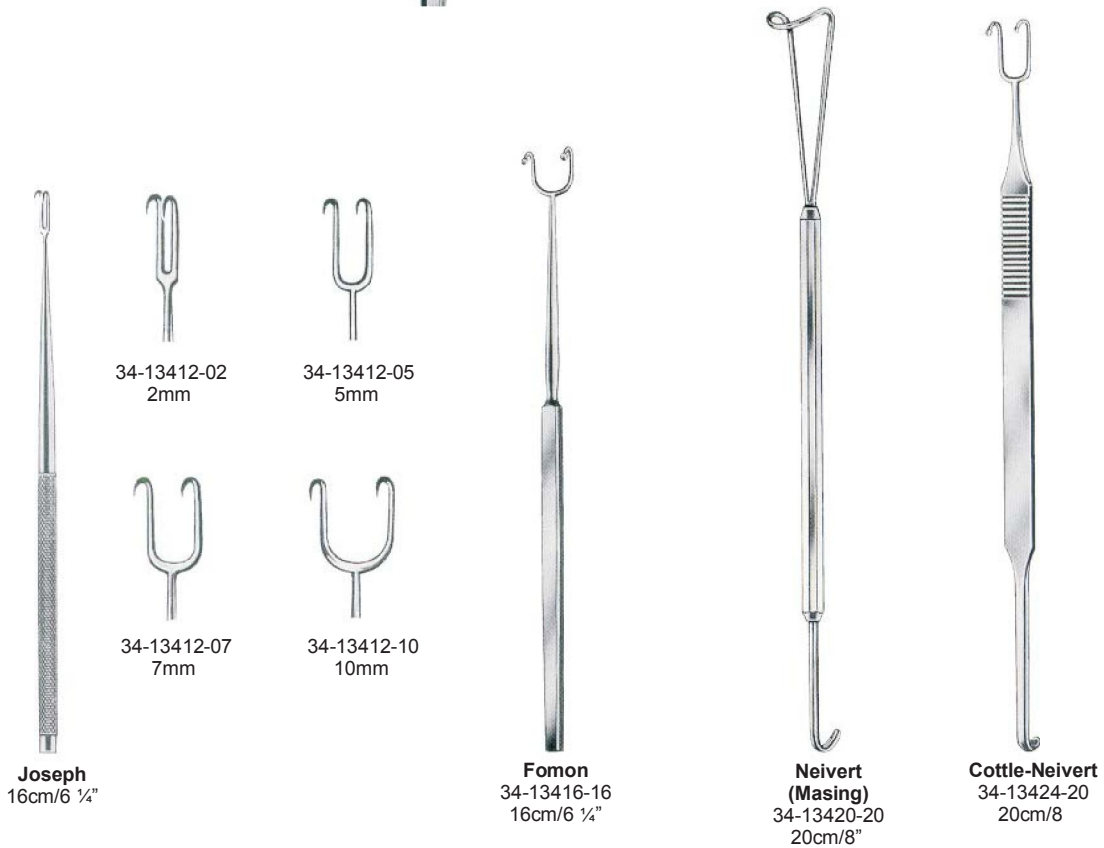

## Hooks



**Fomon**  
34-13428-14  
14.5cm/5 ¾"



**Cottle**  
34-13432-14  
14.5cm/5 ¾"



**Cottle**  
34-13434-14  
14.5cm/5 ¾"



**Cottle**  
34-13436-14  
14.5cm/5 ¾"



**Cottle**  
34-13440-16  
15cm/6"



**Kilner**  
34-13444-08  
8cm/3 ¼"  
10mm

## Columella Forceps

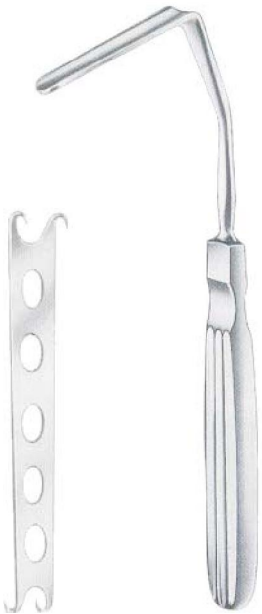

**Converse**  
34-13448-12  
12cm/4 ¾"

**Aufricht**  
34-13452-16  
16cm/6 ¼"



**Cottle**  
34-13456-10  
10cm/4"

## Tissue Lifter



34-13460-14  
14cm/5 ½"

## Tissue Picks



34-13464-11  
11cm/4 ¾"

1.0mm 34-13468-10  
1.8mm 34-13468-18



**Walsham**  
23cm/9"



34-13472-01



34-13472-02



34-13472-03



**Cottle-Walsham**  
34-13474-22  
22cm/8 3/4"



**Asch**  
34-13476-23  
23cm/9"



**Kressner**  
34-13480-20  
20cm/8"



**Rubin**  
34-13484-20  
20cm/8"





**Faulkner**  
34-13488-21  
21cm/8¼"



**Sewall**  
34-13492-20  
20cm/8"  
6mm



**Coakley**  
17cm/6¾"



34-13496-01    34-13496-02    34-13496-03



34-13496-04    34-13496-05    34-13496-06

Ringmesser



**Beckmann**  
22cm/8 ¾"

34-13500-01

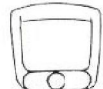

34-13501-01

34-13500-02



34-13501-02

34-13500-03



34-13501-03

34-13500-04



34-13501-04

34-13500-05



34-13501-05

34-13500-06



34-13501-06

AdenoidCurettes



**Negus**  
20cm/8"



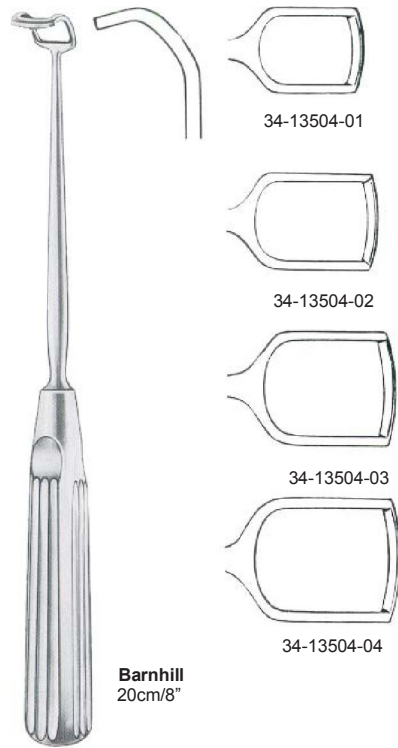

**Barnhill**  
20cm/8"

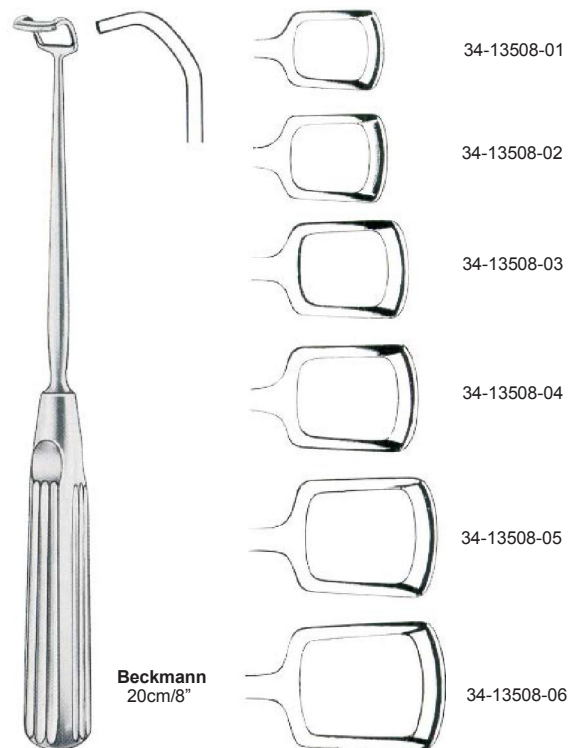

**Beckmann**  
20cm/8"



**St. Clair-Thompson**  
22cm/8 3/4"

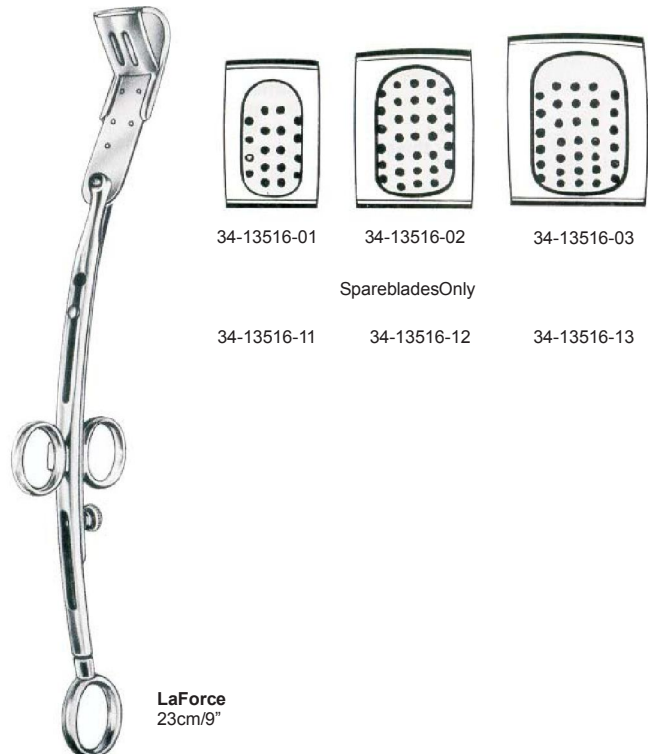

**LaForce**  
23cm/9"



**Bruenings-Brunk**  
34-13520-19  
19cm/7 1/2"



**Siebenmann**



mmØ		
34-13524-15	1.5	34-13526-15
34-13524-17	1.7	34-13526-17
34-13524-20	2.0	34-13526-20
34-13524-25	2.5	34-13526-25
34-13524-30	3.0	34-13526-30



Hartmann		
Fig.1	mmØ	Fig.2
34-13530-20		34-13534-20
34-13530-25		34-13534-25
34-13530-30		34-13534-30



**Eicken-Killian**  
34-13538-03  
3mmØ/



**Killian**  
34-13538-15  
1.5mmØ/



**Ritter-Halle**  
2.5mm 34-13540-25  
3.0mm 34-13540-30  
4.0mm 34-13540-40





**ModellWurzburg**

Fig.		mm
2	35-13562-02	23x65
3	35-13562-03	24x80
4	35-13562-04	25x93
5	35-13562-05	26x108

Fig.		mm
1	35-13566-0128x66	
2	35-13566-0232x75	
3	35-13566-0334x83	
4	35-13566-0437x93	
5	35-13566-0538x100	



ChestSupportfor  
Mouthgag  
35-13570-00



**MouthGags**

**Baby-Molt**  
35-13574-10  
10cm/4"

**Molt**  
35-13576-1111cm/4 1/4"  
35-13576-1414cm/5 1/2"

**Roser-Konig**  
35-13580-1616cm/6 1/4"  
35-13580-1919cm/7 1/2"

**Denhart**  
35-13584-12  
12cm/4 3/4"



**Heister**  
35-13588-13  
13cm/5"



**Fergusson-Ackland**  
35-13592-1818cm/7"  
35-13592-2020cm/8"



**Whitehead**  
35-13596-1111cm/4 1/4"  
35-13596-1313cm/5"  
35-13596-1515cm/6"

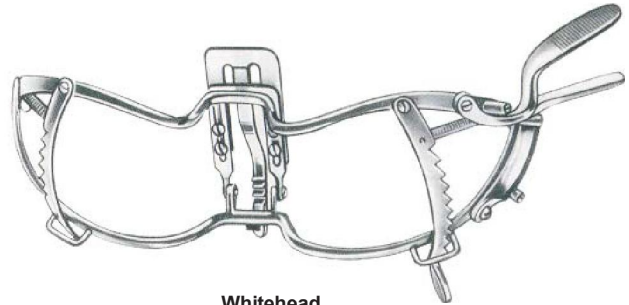

**Whitehead**  
35-13600-13  
13cm/5"



**Jennings**  
35-13604-0909cm/3 1/2"  
35-13604-1111cm/4 1/4"  
35-13604-1313cm/5"  
35-13604-1515cm/6"



**Sternberg**  
35-13608-1212cm/4 3/4"  
35-13608-1414cm/5 1/2"  
35-13608-1616cm/6 1/4"



35-13612-19  
19cm/7 1/2"



**Moritz-Schmidt**  
35-13616-19  
19cm/7 1/2"





**Hartmann**  
35-13620-15  
15cm/6"

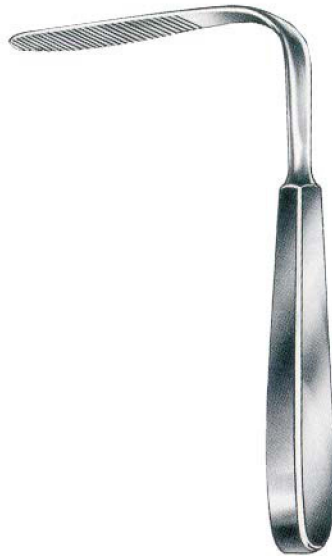

**Tobold**  
35-13624-14  
14.5cm/5 ¾"



**Fraenkel**  
35-13628-19  
19cm/7 ½"



**Frenzel**  
35-13632-16  
16.5cm/6 ½"



35-13636-13  
13cm/5"



35-13640-14  
14.5cm/5 ¾"



35-13646-14  
14.5cm/5 ¾"



**Kroenig**  
35-13650-15  
15cm/6"



**Mayo**  
35-13654-17  
17cm/6 ¾"





**Bruenings**  
35-13658-19  
19cm/7 1/2"



**Bruenings**  
35-13662-19  
19cm/7 1/2"



35-13666-01

35-13666-02

**Wieder**



**Collin**  
35-13670-16  
16cm/6 1/4"



**Collin**  
35-13672-19  
19cm/7 1/2"



35-13676-19  
19cm/7 1/2"



**Young**  
35-13680-17  
17cm/6 3/4"

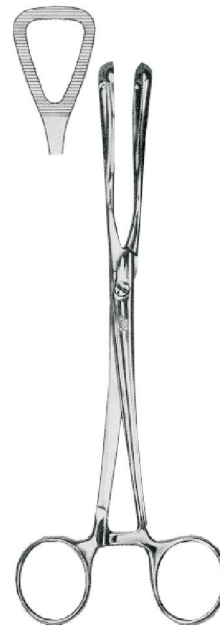

**Guys**  
35-13682-19  
19cm/7 1/2"

FingerProtectors



**Lengenbeck**  
35-13684-01 Ø22.0mm  
35-13684-02 Ø24.5mm  
35-13684-03 Ø26.5mm

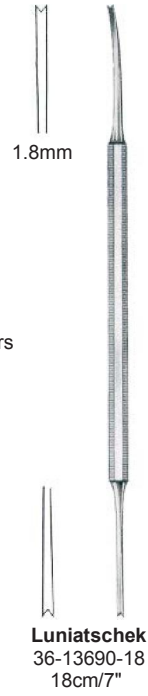

GauzePackers

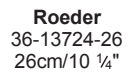
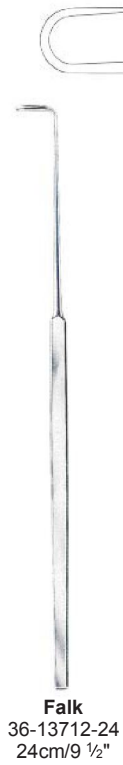



36-13728-17  
17.5cm/6 7/8"



**Fischer**  
36-13732-22  
22.5cm/8 7/8"



**Douglas**  
36-13736-21  
21cm/8 1/4"



**Abraham**  
36-13740-21  
21cm/8 1/4"



**Bruenings**  
36-13744-23  
23cm/9"



**Abraham**  
36-13748-19  
19cm/7 1/2"



**Canfield**  
36-13752-21  
21cm/8 1/4"



**Hurd**  
36-13756-22  
22.5cm/8 7/8"



**Yankauer**  
36-13760-21  
21cm/8 1/4"



**Luniatschek**  
36-13764-19  
19cm/7 1/2"



**Henke**  
23cm/9"



36-13768-01



36-13768-02



**Nager**  
36-13772-23  
23cm/9"



**Wide**  
36-13776-1818mm  
36-13776-2020mm  
36-13776-2222mm



**Love**  
23cm/9"



**Hofer**  
36-13784-24  
24cm/9 1/2"

**Haslinger**  
36-13780-16



**Museux**  
Straight  
36-13788-20  
20cm/8"

Curved  
36-13789-20  
20cm/8"



**Ballenger**  
36-13792-21  
21.5cm/8 1/2"



**White**  
36-13796-1818cm/7"  
36-13796-2323cm/9"



**MarschikKroni**  
36-13800-20  
20.5cm/8"



**Colver**  
Straight  
36-13804-19  
19cm/7 1/2"

Curved  
36-13805-19  
19cm/7 1/2"



**Blohmke**  
36-13808-20  
20cm/8"



**Eves**  
36-13812-28  
28cm/11"



**Eves**  
36-13814-28  
28cm/11"



**Bruenings**  
36-13818-28  
28cm/11"



With 1 Straight Tip

**Brown**  
36-13822-00



With 1 Straight Tip

**Tyding**  
36-13826-00





**Sluder-Ballenger**  
Complete, With 3 Tips  
36-13830-00



TonsilPunchForceps

36-13834-1313mmO /  
36-13834-1515mmO /  
36-13834-1717mmO /



















**Hartmann**

TonsilHaemostats





























**Corwin**  
36-13838-14  
14cm/5 1/2"



	MicroScissors	MicroForceps	CupShapedForceps 2.5mmO/
Straight	 37-13842-01	 37-13844-01	 37-13846-01
StraightHorizontal	 37-13842-02	 37-13844-02	
AngledUp	 37-13842-03	 37-13844-03	 37-13846-03
AngledUpHorizontal	 37-13842-04	 37-13844-04	 37-13846-04
CurvedRight	 37-13842-05	 37-13844-05	 37-13846-05
CurvedLeft	 37-13842-06	 37-13844-06	 37-13846-06
			 Oval 37-13846-07



LengthofShaft

LengthofShaft ForChildren	35cm	40cm	50cm	60cm	
	37-13850-01		37-13852-01	37-13854-01	37-13856-01
	37-13850-02		37-13852-02	37-13854-02	37-13856-02
	37-13850-03		37-13852-03	37-13854-03	37-13856-03
	37-13850-04		37-13852-04	37-13854-04	37-13856-04
	37-13850-05		37-13852-05	37-13854-05	37-13856-05
	37-13850-06		37-13852-06	37-13854-06	37-13856-06
	37-13850-07		37-13852-07	37-13854-07	37-13856-07
	37-13850-08		37-13852-08	37-13854-08	37-13856-08
	37-13850-09		37-13852-09	37-13854-09	37-13856-09
	37-13850-10		37-13852-10	37-13854-10	37-13856-10
	37-13850-11		37-13852-11	37-13854-11	37-13856-11
	37-13850-12		37-13852-12	37-13854-12	37-13856-12
	37-13850-13		37-13852-13	37-13854-13	37-13856-13

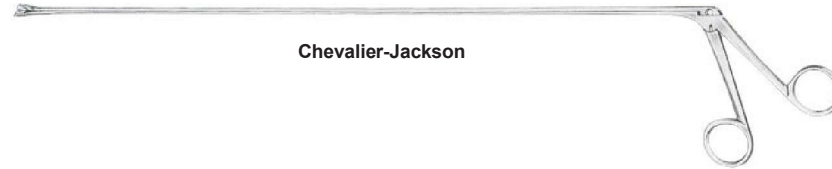

**Chevalier-Jackson**



Length										
cm	in									
30	12	37-13860-30	37-13862-30	37-13864-30	37-13866-30	37-13868-30	37-13870-30	37-13872-30	37-13874-30	
40	16	37-13860-40	37-13862-40	37-13864-40	37-13866-40	37-13868-40	37-13870-40	37-13872-40	37-13874-40	
50	20	37-13860-50	37-13862-50	37-13864-50	37-13866-50	37-13868-50	37-13870-50	37-13872-50	37-13874-50	
60	24	37-13860-60	37-13862-60	37-13864-60	37-13866-60	37-13868-60	37-13870-60	37-13872-60	37-13874-60	

**Interchangeable Tips**



**Huber**  
37-13876-00



**Bruenings**  
37-13880-00

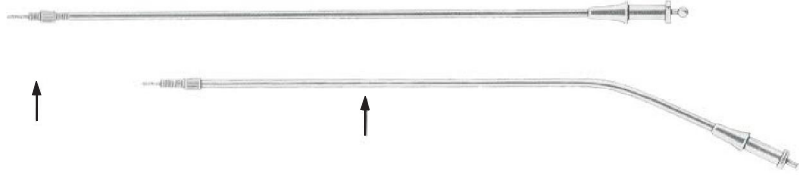

Straight	Lengths		Angular
	cm	in	
37-13884-20	20	08	37-13885-20
37-13884-30	30	12	37-13885-30
37-13884-40	40	16	37-13885-40
37-13884-50	50	20	37-13885-50
37-13884-60	60	24	37-13885-60

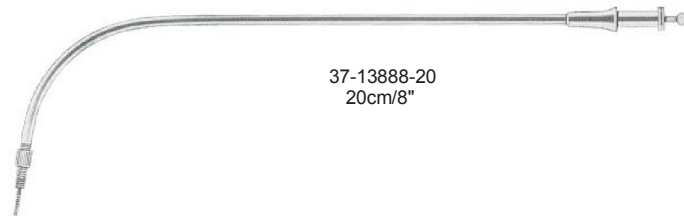

37-13888-20  
20cm/8"



**Baracani**  
37-13890-01



**Seiffert**  
37-13892-01



**Frankel**  
37-13894-01



**Scheinmann**  
37-13896-01



**Scheinmann**  
37-13896-02



**Bruenings**  
37-13898-012mmO /  
37-13898-023mmO /



**Bruenings**  
37-13898-03



**Bruenings**  
37-13898-04



**Lange**  
37-13900-01



**Krause**  
37-13902-01



**Krause**  
37-13904-01



**Cordes**  
37-13906-01



**Schumacher**  
37-13908-01



**Cordes**



37-13910-01



37-13910-02



**Flatau**  
37-13912-01



**Fränkel**  
37-13914-01



MetalHandles



Fig.	mmØ
000	06
00	08
0	10
1	12
2	14
3	16
4	18
5	20
6	22
7	24
8	26
9	28
10	30

37-13916-06
37-13916-08
37-13916-10
37-13916-12
37-13916-14
37-13916-16
37-13916-18
37-13916-20
37-13916-22
37-13916-24
37-13916-26
37-13916-28
37-13916-30

37-13918-06
37-13918-08
37-13918-10
37-13918-12
37-13918-14
37-13918-16
37-13918-18
37-13918-20
37-13918-22
37-13918-24
37-13918-26
37-13918-28
37-13918-30

**Michel**

37-13920-10
37-13920-12
37-13920-14
37-13920-16
37-13920-18
25cm/10"

37-13924-01
-------------





**Fraenkel**  
37-13928-18  
18cm/7"

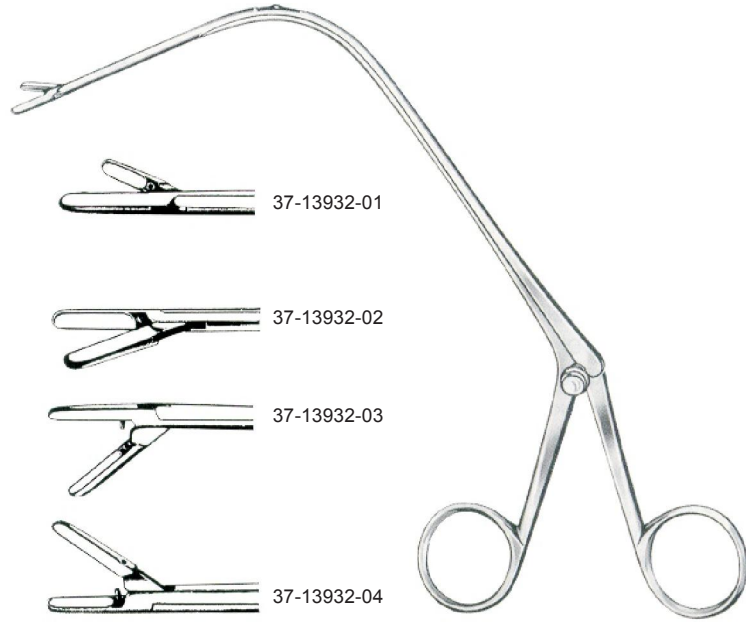

**Jurasz**  
23cm/9"

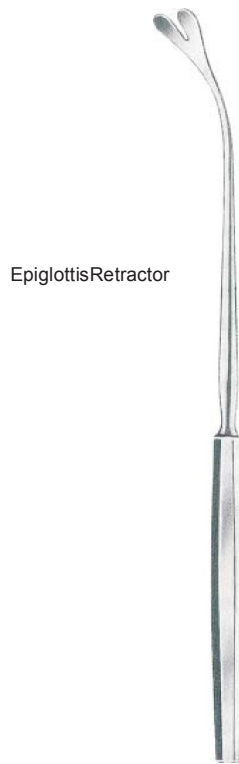

Epiglottis Retractor

**Reichert**  
37-13936-24  
24cm/9 1/2"



**Killian**  
37-13940-20  
20cm/8"



**Davis**  
38-13944-1616cm/6 ¼"  
38-13944-2424cm/9 ½"

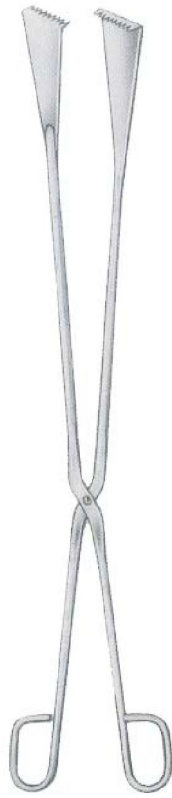

**Sauerbruch**  
38-13948-55  
55cm/21 ½"



38-13952-2020cm/8"  
38-13952-2828cm/11"  
38-13952-3030cm/12"



**Rogge**  
38-13956-23  
23cm/9"



**Cheatle**  
38-13960-27  
27cm/10 ½"



**Universal**  
38-13964-20 20cm/8"  
38-13964-28 28cm/11"

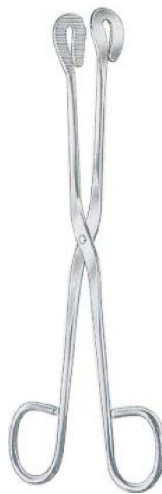

**Universal**  
38-13968-20  
38-13968-28



**Bunt**  
38-13972-01  
10.5cm/4 ¼"

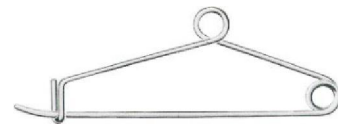

**Mayo**  
38-13972-02  
14cm/5 ½"

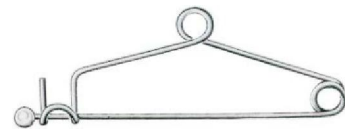

**Mayo**  
38-13972-03  
14cm/5 ½"

Stainless

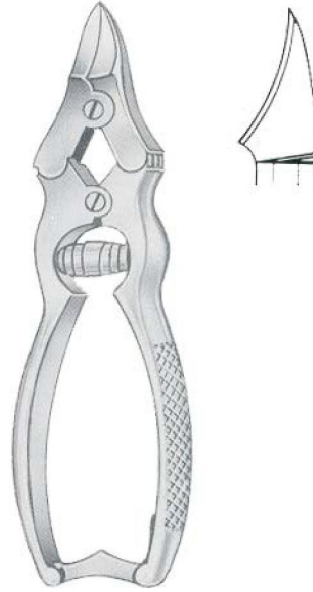

39-13976-15  
15cm/6"



39-13980-10  
39-13981-10  
10cm/4"



Straight  
Curved  
39-13984-10  
39-13985-10  
10cm/4"



39-13992-10  
10cm/4"

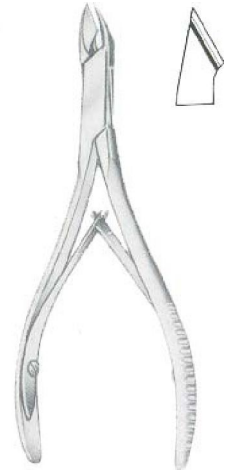

39-13996-11  
11cm/4 1/2"  
39-13996-13



cm	in		
11	4½"	39-14000-11	
13	5"	39-14000-13	
14	5½"		39-14004-14
16	6¼"		39-14004-16



cm	in		
11	4½"		39-14012-11
13	5"		39-14012-13
14	5½"	39-14008-14	
15	6"	39-14008-15	39-14012-15

## A

	Pages#
AbdominalandIntestinalSpatulas	180
AbdominalRetractors	197-202,204-209
AbdominalScissors	50
AbortionScoops	407
<b>ABRAHAM</b> ,TonsilKnives	621
Adenoid,Curettes	612-613
CuttingForceps	599
<b>ADLERKREUTZ</b> ,TissueForceps	103
<b>ADSON</b> ,AtraumaticTissueForceps	111
BoneRongeurForceps	302
DressingForceps	96
DrillGuideForceps	312
HemostaticForceps	124
LigatureForceps	109
NeedleHolders	232
NerveRetractors	523
PeriostealRaspatories	276
Retractors	194-196
SuctionTubes	10
TissueForceps	102
<b>ADSON-BABY</b> ,Retractors	193
<b>ADSON-BROWN</b> ,TissueForceps	102
AdvancementForceps	490-491
<b>AEBLI</b> ,IridectomyScissors	67
<b>AGRICOLA</b> ,EyeSpecula	462
AirwayCannulas	14
AlarProtectors	610
<b>ALDERDYCE</b> ,Elevators	283
<b>ALEXANDER</b> ,BoneChisels	260
BoneGouges	260
CervicalBiopsyandSpecimenForceps	396
PeriostealRaspatories	275
<b>ALLEN</b> ,IntestinalClampForceps	339
<b>ALLIS</b> ,IntestinalTissueForceps	330
<b>ALLIS-ADAIR</b> ,IntestinalTissueForceps	330
<b>ALLIS-ATRAUMA</b> ,IntestinalTissueForceps	330
<b>ALLISON</b> ,LungSpatulas	420
<b>ALLPORT</b> ,Retractors	190
<b>ALM</b> ,Retractors	190
<b>ALVIS</b> ,ForeignBodyCurettes	469
<b>ALY</b> ,SensibilityInstruments	1
AmniotomefortheAmnionBladder	386
AmputationKnives	27
AmputationSaws	310
AnalRetractors	347
AnastomosisClampForceps	428,438,442,446
<b>ANDERSON-ADSON</b> ,Retractors	194
<b>ANDERSON-CRITCHETT</b> ,PterygiumKnives	469
<b>ANDREW-PYNCHON</b> ,SuctionTubes	11
<b>ANEL</b> ,LachrymalCannulas	481
AneurysmClamps	430-431,443
AnteriorChamberForceps	492
AntrumandFrontalSinusWashCannulas	614
PunchForceps	598
Anusscopes	345-346
AorticAnastomosisClamps	428,437-438,442,451
AorticAneurysmClamps	430-431,443
AorticClamps	432,453-456
AorticDilators	457
AphlaChymotrypsinCannulas	482
ApplyingandRemovingForceps	508
ApplyingForceps ForBulldogClamps	115,149
<b>ARIT</b> ,LensScoops	475
<b>ARROWSWORTH</b> ,CornealFixationForceps	501
<b>ARRUGA</b> ,CapsularForceps	498-499
ExtractionHooks	471
EyeSpecula	460
MicroNeedleHolders	226
MicroNeedleHolders	242
Protectors	472
<b>ARRUGA-NIZETIC</b> ,CapsularForceps	498
ArteriotomyScissors	60
<b>ASCH</b> ,SeptumForceps	611
AsepsisInstruments	633
Atrauma,AnastomosisForcep	428,437-438,442,451
AorticAneurysmClamps	430-431,443
AorticClamps	432,435-436
AuricleClamps	443
BronchusClamps	434

	Pages#
BulldogClamps	424-426
CardioVascularForceps	429,439-440,447
CardidClamps	448
CoarctionClamps	427,443,449
HemostaticForceps	444
IntestinalTissueForceps	332,334,336,338,342
LigatureClamps	446,452
MultiPurposeClamps	441,445,450
NeontalClamps	454-455
PediatricClamps	453-454
ProtundaClamps	446
TangentialOcclusionClamps	437
TissueForceps	111,422-423
<b>AUFRICHT</b> ,NasalRasps <b>TC</b>	607
NasalRetractors	610
AuricleClamps	433
<b>AUSTIN</b> ,MicroForceps	8
AutopsyKnives	28-29
<b>AUVARD</b> ,VaginalSpeculas	377
Awls	312
AwlsforMaxillofacialSurgery	189
<b>AXENFELD</b> ,ChalazionCurettes,DoubleEnd	477
EyeHooks	473
<b>AYER</b> ,Cannulas	15
<b>AYER</b> ,ChalazionForceps	500

## B

<b>BABCOCK</b> ,IntestinalTissueForceps	331
<b>BABCOCK</b> ,IntestinalTissueForceps <b>TC</b>	331
<b>BABCOCK-ATRAUMA</b> ,IntestinalTissueForceps	331
<b>BABINSKY</b> ,PercussionHammers	3
<b>BABY-ADSON</b> ,HemostaticForceps	124
<b>BABY-ALLIS</b> ,IntestinalTissueForceps	330
<b>BABY-BABCOCK</b> ,IntestinalTissueForceps	331
<b>BABY-BALFOUR</b> ,AbdominalRetractors	203
<b>BABY-COLLIN</b> ,IntestinalRetractors	198
<b>BABY-COLEY</b> ,RibSpreaders	415,418
<b>BABY-CRILE</b> ,HemostaticForceps	119
<b>BABY-CRILE-WOOD</b> ,NeedleHolders <b>TC</b>	237
<b>BABY-DOYEN</b> ,IntestinalClampForceps	333
<b>BABY-HEGEMANN</b> ,VascularScissors	58
<b>BABY-LEXER(KNAPP)</b> , Scissors	54
<b>BABY-METZENBAUM</b> ,Scissors, SuperCut	34
<b>BABY-MIKULICZ</b> ,PeritonealClampForceps	140
<b>BABY-MIXTER</b> ,DissectingandLigatureForcep	132
<b>BABY-MOLT</b> ,MouthGags	616
<b>BABY-OLSEN-HEGAR</b> ,NeedleHoldersWithScissors	232
NeedleHolderwithScissors <b>TC</b>	243
<b>BABY-OVERHOLT</b> ,DissectingandLigatureForceps	128
<b>BABY-POOLE</b> ,SuctionTube	12
<b>BABY-ROUX</b> ,Retractors	180
<b>BABY-SATINSKY</b> ,BloodVesselClamps	422
<b>BABY-SENN-MILLER</b> ,Retractors	159
<b>BABY-TROUSSEAU</b> ,TracheaDilators	325
<b>BACKHAUS</b> ,TowelForceps	142
<b>BACON</b> ,BoneRongeurs	300
<b>BAILEY</b> ,RibContractors	420
<b>BAILEY-BABY</b> ,RibContractors	420
<b>BAILEY-GIBBONS</b> ,RibContractors	420
<b>BAINBRIDGE</b> ,AtraumaCardiovasculaForceps	430
HemostaticForceps	123
<b>BAKE</b> ,GallDuctProbes	357
<b>BALFOUR(USAPATT)</b> , AbdominalRetractors	206
<b>BALFOUR</b> ,AbdominalRetractors	204-206
<b>BALLENGER</b> ,Chisels	603
SwivelKnives	600
TonsilForceps	623
<b>BALLENTINE</b> ,HysterectomyForceps	136
BandPushers	189
BandageScissors	87-89
<b>BANE-HARTMANN</b> ,BoneRongeursForceps	299
<b>BANGERTER</b> ,CyclodialysisSpatulas	481
<b>BARACANI</b> ,Tips	629
<b>BARBARA</b> ,MicroNeedles	579-580
<b>BARBARA</b> ,MicroHooks	579-580
<b>BARKEN</b> ,GoniotomyKnives	469

## B

	Pages#		Pages#
<b>BARNES-NEVILLE</b> ,ObstetricalForceps	411	HoldingForceps	292-296
<b>BARNHILL</b> ,AdenoidCurettes	613	Instruments	258-324
<b>BARON-SCHUKNECHT</b> ,SuctionTubes	568	Levers	282-289
<b>BARR</b> ,RectalSpeculas	345	Osteotomes	258-263
<b>BARRAQUER</b> ,AnteriorChamberForceps	492	Rasps	273
CiliaForceps	110	Retractors	162-163
EyeSpeculas	459	RongeurForceps	299-306
FixationForceps	504	Wires	319
MicroNeedleHolders <b>TC</b>	227	WireGuides	319
MicroScissors	65	WireTighteners	319
SutureForceps	488	<b>BONN</b> ,EyeScissors	82
<b>BARRAQUER-COLIBRI</b> ,EyeSpeculas	459	IrisForceps	493
IrisForceps	492,494	IrisHooks	471
<b>ARRAQUER-KATIN(COLIBRI)</b> , FixationForcep	497	IrrigatingCannulas	478
<b>BARRETT</b> ,TenaculumForceps	385	LachrymalCannulas	481
<b>BARSKY</b> ,Retractors	377	<b>BONNEY</b> ,DressingForceps	97
<b>BARTH</b> ,BoneCurettes	271,585	TissueForceps	106
Basiotribes	408	<b>BORES</b> , CornealFixationForceps	501
<b>BEACHAM</b> ,Amniotome	386	CornealMarkers	487
<b>BEAUPRE</b> ,CiliaForceps	109	MarkingInstruments	487
<b>BECK</b> ,AnastomosisClamps	451	<b>BOSE</b> ,Retractors	190,325
AtraumaCardiovascularForceps	438	TracheaDilators	325
<b>BECKER</b> ,Cystotomes	470	TracheaHooks	325
<b>BECKMANN</b> ,AdenoidCurettes	612-613	<b>BOUCHERON</b> ,EarSpeculas	565
NasalSpeculas	590	<b>BOWDLER-HENRY'S</b> ,Osteotomes,	188
<b>BECKMANN-ADSON</b> ,Retractors	195-196	<b>BOWLES</b> ,Stethoscopes	1
<b>BECKMANN-EATON</b> ,Retractors	197	<b>BOWMANN</b> ,DissectionKnives	467
<b>BEEBEE</b> ,CrownScissors	91	DissectionNeedles	469
<b>BEER</b> ,CiliaForceps	110	EyeSpeculas	459
<b>BEESON</b> ,PlasterSpreaders	256	LachrymalProbes	484
<b>BELLUCCI</b> ,MicroScissors	573,575	<b>BOYNTON</b> ,NeedleHolders	226
<b>BENGOLA</b> ,HemostaticForceps	125	NeedleHolders <b>TC</b>	242
<b>BENNETT</b> ,BoneLevers	289	<b>BOYS-ALLIS</b> ,IntestinalTissueForceps	330
CiliaForceps	109	<b>BOZEMANN</b> ,DressingForceps	147
<b>BENSAUDE</b> ,Anuscopes	345	LoopTwisters	254
<b>BENSON</b> ,PylorusSpreaders	339	NeedleHolders	235
<b>BERENS</b> ,Keratomes	446	<b>BOZEMANN-DOUGLAS</b> ,CottonSwabForceps	148
ScleralHooks	472	Brain,Knives	28
<b>BERGER</b> ,CervicalBiopsyandSpecimenForceps	394	Spatulas	520-521
<b>BERGMAN</b> ,BandageScissors	88	<b>BRAND</b> ,TendonSeizingInstruments	122
OperatingKnives	25	TendonStrippers	322
Retractors	156	<b>BRAUN</b> ,Cranioclasts	408
<b>BERKE</b> ,AdvancementForceps	490	DecapitatingHooks	408
<b>BERLINER</b> ,PercussionHammers	2	TenaculumForceps	385,387
<b>BERNHARD</b> ,TowelForceps	143	UterineDepressors	382
<b>BETHUNE</b> ,RibShears	412	VaginalSpeculas	373-374
<b>BEYER</b> ,BoneRongeurs	301,303	<b>BRAUN-STADLER</b> ,PerineumScissors	62
<b>BILL</b> ,TractionHandles	410	PerineumScissors,SuperCut	37
<b>BILLEAU</b> ,EarLoops	585	<b>BREISKY</b> ,Pelvimeters	405
<b>BINKHORST</b> ,CapsularForceps	498	VaginalSpeculas	377
IrrigatingCannulas	478	<b>BRIDGE</b> ,HemostaticForceps	125
Biopsy,Forceps	393-398	<b>BRISTOW</b> ,BoneLevers	288
AspiratingCurettes	391-392,401	<b>BRODIE</b> ,Probes	210
<b>BIRCHER</b> ,MeniscotomyKnives	291	Broncho-EsophagoscopyInstruments	628-631
<b>BIRCHER-GANSKE</b> ,BoneHoldingForceps	293	BronchusForceps	127,421
<b>BIRKETT</b> ,HemostaticForceps	125	<b>BROPHY</b> ,DressingForceps	97
<b>BISHOP</b> ,IrisForceps	493	Scissors	52
BladderRetractors	361-363	TissueForceps	104
<b>BLAKE(ZWEIFEL)</b> ,UterineCurettes	404	<b>BROWN</b> ,NeedleHolders	229
<b>BLAKE</b> ,GallStoneForceps	356	Snare	624
<b>BLASCOVICS</b> ,MuscleForceps	490	TissueForceps	103
Blindgut Forceps	339	<b>BRUENINGS</b> ,SeptumForceps	595
BloodVesselClamps	421-422	SeptumKnives	584,600
<b>BLOHMKE</b> ,TonsilSeizingForceps	623	Tips	629
<b>BLOUNT</b> ,BoneLevers	289-290	TongueDepressors	619
MeniscusRetractors	172	TonsilKnives	621
<b>BLUMENTHAL</b> ,BoneRongeursForceps	301	TonsilSnare	624
<b>BOETTCHER</b> ,TonsilScissors	60	UniversalHandles	626
<b>BOHLER</b> ,BoneCuttingForceps	307	<b>BRUENINGS-BRUNK</b> ,AntrumRetractors	614
BoneRongeurForceps	303	<b>BRUNETTI</b> ,Chisels	31
ExtensionBows	317	<b>BRUNNER</b> ,IntestinalClampsForceps	336
<b>BONACCOLTO</b> ,SutureForceps	489	LigatureConductors	251-252
Bone,Chisels	258-263	LigatureNeedles	251
Curettes	265-272	Retractors	176
CuttingForceps	307-308	RibShears	412
Files	273	<b>BRUNNER-FERROZELL</b> ,Conductors	251-252
Gouges	258-264	<b>BRUNS</b> ,BandageScissors	89
HandDrills	311	BoneCurettes	266-267
HoldingClamps	298	<b>BRYANT</b> ,CottonSwabForceps	145



## B

<b>BUCK</b> , EarCurettes	585
ForeignBodyLevers	570
PercussionHammers	2
<b>BUCK-GRAMCKO</b> , BoneLevers	284
<b>BUCKINGHAM</b> , HandInstruments	582
<b>BUELAU</b> , Trocars	7
<b>BUIE</b> , ClampForceps	137
Probes	211
RectalAspirationCannulas	349
Bulldog, Clamps	115, 149
Atrauma	149
<b>BUMM</b> , UterineCurettes	404
<b>BUNGE</b> , ExenterationScoops	477
<b>BUNT</b> , WasteClamps	632
<b>BURCH</b> , FixationHooks	469
<b>BURKE</b> , CervicalBiopsyandSpecimenForceps	397
<b>BURFORD</b> , RibSpreaders	419
<b>BUSCH</b> , UmbilicalScissors	62
<b>BUSCHE</b> , BoneCurettes	270

## C

Calipers	5
analiculusKnives	467
<b>CANFIELD</b> , TonsilKnives	621
Cannulas	15, 478-482
<b>CAPLAN</b> , SeptumForceps	597
CapsularForceps	496-498
CapsulePolishingInstruments	480
Cardiovascular, Forceps	421-455
Instruments	412-458
<b>CAROLL</b> , Goniometers	5
TendonSeizingInstruments	324
CarotidClamps	448-449
<b>CARREL</b> , HemostaticForceps	115
Cartilage, Knives	29
Scissors	58
<b>CASPER</b> , LaminaSpreader	510-511
MicroDissectors	557-559
Retractors	169
<b>CASTANEDA</b> , NeonatalClamps	455
RibSpreaders	418
<b>CASTROVIEJO</b> , CalipersandMarkers	483
CapsularForceps	498
CyclodialysisSpatulas	474, 485
EyeKnives	466
EyeSpatulas	474-475, 485
EyeSpeculas	462
FixationForceps	502-503
IridectomyScissors	67, 69
Keratomes	466
LachrymalDilators	484
MicroNeedleHolders	216-217, 226
MicroNeedleHolders TC	226, 227
RazorBladeBreakers	30
SutureForceps	502
<b>CASTROVIEJO-BARRAQUER</b> , EyeSpatulas	474
<b>CASTROVIEJO-KALT</b> , MicroNeedleHolders	225
CataractKnives	464
Spoons	425
Catheter, Forceps	14
IntroducingInstruments	14
<b>CATLIN</b> , AmputationKnives	27
CephalotomyScissors	50
Cervical, BiopsyandSpecimenForceps	395-398
TractionTongs	507
<b>CHADWICK</b> , EyeScissors	83
GumScissors	94
Chalazion, Curettes	476
CurettesDouble	477
Forceps	500
<b>CHANDLER</b> , BoneLevers	289
IrisForceps	496
<b>CHAPUT</b> , HemostaticForceps	115
<b>CHARRIERE</b> , AmputationSaws	310
<b>CHEATLE</b> , SterilizingForceps	632
CheekRetractors	182
<b>CHERON</b> , CottonSwabForceps	147

ChestSupportForMouthGags	616
<b>CHEVALIER-JACKSON</b> , Broncho-EsophagoscopyForceps	628
TracheaTubes	326
<b>CHILD</b> , IntestinalClampForceps	332
WoundSutureForceps	255
Chisels	258-264, 603-605
CiliaForceps	109-110
<b>CINELLI</b> , Chisels	604
CircumcisionInstruments	365
<b>CITELLI</b> , EarPunch	584
<b>CITELLI-BEYER</b> , EarPunch	584
Clamps	137-139
<b>CLAUS</b> , TonsilNeedles	620
<b>CLAUS-EICKEN</b> , TonsilNeedles	620
CleftPalateKnives	621
<b>CLEVELAND</b> , BoneCuttingForceps	307
BoneRongeurForceps	300
ClipApplyingForceps	255
ClothingScissors	90
<b>CLOWARD</b> , BoneChisels	259
BoneGouges	259
LaminaSpreaders	512-513
NerveRetractors	524
<b>COAKLEY</b> , Curettes	612
Trocars	8
CoarctationClamps	443-449
<b>COBB</b> , Gouges	264
PeriostealRaspatories	271, 281
<b>COLCULUGH</b> , RongeurForceps	529
CollarButtonCannulas	482
<b>COLLER-CRILE</b> , HemostaticForceps	120
<b>COLLIER</b> , NeedleHolders	229
<b>COLLIN</b> , AbdominalRetractors	198-199
ClipApplyingForceps	255
CottonSwabForceps	147
Dynamometers	5
HemostaticForceps	116
Pelvimeters	405
Retractors	161
RibShears	90
TongueForceps	619
UmbilicalCordClamps	408
UterineCurettes	400
UterineElevatingForceps	389
UterineSounds	382
VaginalSpeculas	367
<b>COLLIN-DUVAL</b> , GraspingForceps	105
<b>COLLIN-HARTMANN</b> , Retractors	160
<b>COLLIN-LANDAU</b> , VaginalSpeculas	367
<b>COLLIN-POZZI</b> , TenculumForceps	385
<b>COLLYER</b> , Pelvimeters	405
ColumellaForceps	610
<b>COLVER</b> , TonsilSeizingForceps	623
ComedoneExtractors	328
Conductors	506
<b>CONE(ADSON-BABY)</b> , Retractors	193
<b>CONE</b> , Knives	390
Retractors	194
ConjunctivalForceps	495
<b>CONNEL</b> , Airways	14
<b>CONNIN-AMSLER</b> , MarkingInstruments	483
<b>CONVERSE</b> , NeedleHolders TC	237
RhinoplasticHooks	610
RhinoplasticKnives	599
<b>CONWAY</b> , LidRetractors	463
<b>COOK</b> , EyeSpeculas	461
<b>COOLY</b> , AnastomosisClamps	451
AorticDilators	458
AtraumaDissectingForceps	424
AtraumaPediatricClamps	453
CarotidClamps	448
CoarctationClamps	449
LigatureClamps	452
MultiPurposeClamps	450
Retractors	181
RibShears	415, 418
SuctionTubes	456
VascularDilators	457
<b>COOLY-DERRA</b> , AtraumaCardiovascularForceps	452

## C

<b>COPPER</b> , Ligature Needles	248	<b>DAVIDSON-ALEXANDER</b> , Periosteal Raspatories	275
<b>CORDES</b> Tips	629	<b>DAVIEL</b> , Cataract Spoons	475
<b>CORWIN</b> , Tonsil Hemostatic Forceps	625	<b>DAVIS</b> , Dissectors	517
Corneal, Dissectors	477	Foreign Body Needles	470
Fixation Forceps	501	<b>DAVIS-BOYLE</b> , Mouth Gags	615
Knives	468	<b>DAY</b> , Hooks	586
Scarifiers	468	<b>DE-BAKEY</b> , Aortic Aneurysm Clamps	431
Coronary Scissors	55	Aortic Clamps	435
Cortex Aspirating Canulas	480	Atrauma Bulldog Clamps	424
<b>CORYLLOS</b> , Retractors	177	Atrauma Cardiovascular Forceps	429, 439, 447
<b>COS</b> , Micro Forceps	573	Atrauma Tissue Forceps	422-423
<b>COTTLE</b> , Alar Protectors	610	Carotid Clamps Forceps	426
Chisels	603-604	Dissecting and Ligature Forceps	428
Columella Forceps	610	Ligature Clamps	435
Mallets	320	Multi Purpose Clamps	441, 445
Nasal Rasps	608	Needle Holders	236
Nasal Scissors	63	Peripheral Clamps	439
Nasal Speculas	592	Retractors	201
Rhinoplastic Hooks	609-610	Rib Spreaders	416
Rhino Knives	600	Vascular Forceps	458
Scissors, <b>SuperCut</b>	37	Vascular Scissors	55, 58
Septum Elevators	601-602	<b>DE-BAKEY-BAHNSON</b> , Aorta Aneurysm Clamps	443
<b>COTTLE-NEIVERT</b> , Rhinoplastic Hooks	609	<b>DE-BAKEY-BAINBRIDGE</b> , Atrauma Cardiovascular Forceps	429
<b>COTTLE-WALSHAM</b> , Septum Straightening Forceps	611	<b>DE-BAKEY-BECK</b> , Atrauma Cardiovascular Forceps	439
Cotton, Applicators	211-213	<b>DE-BAKEY-FNE</b> , Needle Holders <b>TC</b>	236
Swab Forceps	145, 147-148	<b>DE-BAKEY-MOSQUITIO</b> , Atrauma Hemostatic Forceps	444
Cover Glass Forceps	110	<b>DE-BAKEY-PEAN</b> , Atrauma Hemostatic Forceps	444
Gauze, Packers	620	<b>DE-BAKEY-RANKIN</b> , Atrauma Hemostatic Forceps	445
<b>CRAFOORD</b> , Hemostatic Forceps	127	<b>DE-BAKEY-SATINSKY</b> , Bulldog Clamps	425-426
Lobectomy Scissors	61	<b>DE-BAKEY-SEMB</b> , Ligature Clamps	436
<b>GRAIG</b> , Septum Forceps	594	<b>DELEE</b> , Obstetrical Forceps	410
<b>CRAIG-DOMNICK</b> , Septum Forceps	594	Pelvimeters	405
Cranioclasts	408	<b>DEVILLBISS</b> , Cranial Forceps	506
<b>CRAWFORD</b> , Retractors	172	<b>DEAN</b> , Eye Knives	468
<b>CRILE</b> , Hemostatic Forceps	119	Gum Scissors	93
Needle Holders	233	<b>DEAVER</b> , Retractors	178
Retractors	150, 157	Retractors Handles	178
<b>CRILE-BABY</b> , Hemostatic Forceps	119	Scissors	40
<b>CRILE-MURRAY</b> , Needle Holders	233	Decapitating Hooks	408
<b>CRILE-RANKIN</b> , Hemostatic Forceps	232	<b>DECKER</b> , Micro Scissors	540
<b>CRILE-WOOD</b> , Needle Holders	232	<b>DEJERINE</b> , Percussion Hammers	2
Needle Holders <b>TC</b>	237	<b>DEMEL</b> , Bone Wire Guides	319
<b>CRITCHETT</b> , Eye Speculas	462	<b>DENHART</b> , Mouth Gags	616
Crown Scissors	91	<b>DENIS-BROWN</b> , Abdominal Retractors	208
Crurotomy Forceps	576	<b>DERF</b> , Needle Holders	229
<b>CRUTCHFIELD</b> , Bone Drills	507	Needle Holders <b>TC</b>	235
Cervical Traction Tongs	507	Dermatology Instruments	328-329
<b>CULLER</b> , Iris Spatulas	473	<b>DERRA-DEBAKEY</b> , Atrauma Cardiovascular Forceps	446
Muscle Hooks	471	<b>DESCHAMPS</b> , Ligature Needles	241-246
<b>CUSCO</b> , Vaginal Speculas	366	<b>DESJARDINS</b> , Gall Duct and Cystic Forceps	355
<b>CUSHING</b> , Brain Spatulas	520	Gall Stone Forceps	356
Decompression Hooks	158	Gall Stone Probes	357
Dressing Forceps	99	Gall Stone Scoops	358
Laminectomy Rongeur Forceps	530-531	<b>DESMARRES</b> , Chalazion Forceps	500
Nerve Retractors	523	Corneal Knives	468
Retractors	150, 157-158	Lid Retractors	463
Tissue Forceps	104	Retracotrs	157
<b>CUSHING-LANDOLT</b> , Speculas	563	<b>DIEFFENBACH</b> , Bulldog Clamps	115
<b>CUSHING-KOCHER</b> , Retractors	158	Operating Knives	24-25
<b>CUSHING-TAYOR</b> , Dressing Forceps	99	<b>DIETER</b> , Micro Forceps	573
Cyclodialyse, Spatulas	473-474	<b>DIETRICH</b> , Aortic Clamps	432
Spoons	485	Bulldog Clamps	149
Cystotome Cannulas	497	Micro Needle Holders <b>TC</b>	228
Cystotomes	471	Dilating Bougies	363
<b>CZERNY</b> , Gall Stone Forceps Forceps	356	<b>DINGMAN</b> , Bone Holding Forceps	292
Rectal Speculas	344	Raspatories	187
Tenaculum	386	Retractors	186
		Wire Guides	186
		<b>DINGMANN</b> , Mouth Gags	615
		Directors, With Tongue Tie	210
		With Probes	210
		Dissection Needles	469
		Dissecting and Ligature Forceps	124, 128-134
		Dissecting, Knives	22
		Scissors	43-48, 55, 60, 64, 84
		Dissecting Sets	33
		Dissectors	517-519, 552-553
		<b>DITTAL</b> , Dilating Bougies	363
		<b>DIX</b> , Double-Ended Instruments	485

## D

<b>DAHLGREN</b> , Cranial Forceps	506
<b>DANDY</b> , Hemostatic Forceps	122
Nerve Retractors	524
Scissors	64, 84
<b>DARDIK</b> , Atrauma Cardiovascular Forceps	440
<b>DARTIGUES</b> , Uterine Elevating Forceps	389
<b>DASTOOR</b> , Erisiphakes	499
<b>DAUBENSPECK</b> , Bone Curettes	270
<b>DAVIDSON</b> , Retractors	181

## D

ForeignBodyInstruments	
<b>DIXON-LOVELACE</b> ,HemostaticForceps	123
<b>DOCKHORN</b> ,CheekRetractors	182
Double,FixationForceps	472
EndedInstruments	485-486
<b>DOUAY</b> ,CervicalBiopsyandSpecimen Forceps	395
<b>DOUGLAS</b> ,CiliaForceps	110
TonsilKnives	621
Trocars	8
<b>DOYEN</b> ,AbdominalRetractors	209
GynaecologicalScissors	50
IntestinalClampForceps	333
MyomaScrews	390
OvarianForceps	389
PeriostealRaspatories	278
Retractors	175
TowelForceps	143
VaginalSpeculas	375-376
<b>DOYEN-ATRAUMA</b> ,IntestinalClampForceps	334
<b>DOYEN-STILLE</b> ,Retractors	175
DressingForceps	95-99
DrillGuideandDuraProtectingForceps	312
<b>DUAL</b> ,Stethoscopes	1
<b>DUBOIS</b> ,GynecologicalScissors	50
<b>DUNCAN</b> ,BiopsyCurettes	392
<b>DUPLAY</b> ,Polypus andDressingForceps	146
TenaculumForceps	385
<b>DUPUY-WEISS</b> ,LigatureNeedles	247
Dura,Dissectors	517-519
Elevators	517-519
Scissors	84
<b>DURANTE</b> ,TissueForceps	105
<b>DURHAM</b> ,LigatureNeedles	247
<b>DUVAL</b> ,IntestinalTissueForceps	332
TissueForceps	105
Dynamometers	5

## E

Ear,Cannulas	15
Catheters	568
Curettes	585
DressingForecps	111,568
Knives	578,586-587
Loops	585
PolypusForceps	570-571
PolypusSnare	569
Punches	584
Speculas	564-566
Spoons	585
Syringes	588
<b>EASTMAN</b> ,VaginalSpeculas	371
<b>ECHLIN</b> ,BoneRongeurForceps	306
<b>EICKEN-KILLIAN</b> ,WashCannulas	614
<b>EISELSBERG</b> ,LigatureScissors	86
ElevatingSpoons	407
Elevators	282-283
<b>ELLIOT</b> ,ObstetricalForceps	411
<b>ELLIS</b> ,ForeignBodyGouges	470
<b>ELSAESSER</b> ,NephrostomyForceps	354
<b>ELSCHNIG</b> ,CapsularForceps	497-498
CornealKnives	468
EyeSpatulas	474
TissueForceps	505
<b>EMMET</b> ,FistulaHooks	390
FistulaHooksLaser	384
PolypusForceps	147
EndarterectomyScissors, <b>SuperCut</b>	36
EndarterectomyStrippers	215
EndolaryngealMicroSurgeryInstruments	626-627
Endospecula	381
<b>ENGEL</b> ,PlasterSaws	56
<b>ENGLISHPATTERN</b> , DressingForceps	95
TowelForceps	142
EnterotomyScissors	61
EntropiumForceps	491
Enucleation,Scissors	52
Scoops	476
EpiglottisRetractors	631

## Pages#

Episiotomy,Scissors	62
<b>EPPENDORF</b> ,CervicalBiopsyandSpecimen Forceps	396
<b>EPSTEIN</b> ,BoneCurettes	272
<b>ERHARDT</b> ,EarSpeculas	564
EntropiumForceps	491
Erisiphakes	499
<b>ERMOLD</b> ,NeedleHolders	232
<b>ESMARCH</b> ,BandageScissors	88
PlasterKnives	256
EustachinCatheters	568
<b>EVES</b> ,TonsilSnare	624
<b>EWALD</b> ,DressingForceps	96
TissueForceps	102
ExenterationScoops	477
ExtensionBows	317-318
ExtirpationChisels	470
Eye,Cannulas	478-482
ExtractionHooks	471-472
Hooks	471-472
Instruments	458-505
Knives	464-466,469
KnivesLancedForm	467
LigatureNeedles	505
MuscleHooks	473
Protectors	473
Scalpels	464
Scissors	80-82
Spatulas	474
Speculas	459-462

## F

<b>FAGER</b> ,Dissectors	518
<b>FAHLBUSCH</b> ,Curettes	562
PituitaryInstruments	562
<b>FALK</b> ,TonsilNeedles	620
<b>FARABEUF</b> ,BoneHoldingForceps	296
PeriostealRaspatories	279
Retractors	161
<b>FARABEUF-COLLIN</b> ,PeriostealRaspatories	279
<b>FARABEUF-LAMBOTTE</b> ,BoneHoldingForceps	297
<b>FARREL</b> ,CottonApplicators	212
<b>FAULKNER</b> ,Curettes	612
<b>FAURE</b> ,CervicalBiopsyandSpecimenForceps	394
ClampForceps	139
HysterectomyForceps	140
<b>FAVALORO</b> ,VascularScissors	55
<b>FEHLAND</b> ,IntestinalClampForceps	336
<b>FEILCHENFELD</b> ,SplinterForceps	108
<b>FEIN</b> ,CottonApplicators	211
<b>FERGUSON</b> ,BoneHoldingForceps	293
GallStoneScoops	359
HaemorrhoidalClamps	136
UterineScissors	42
SuctionTubes	9
<b>FERGUSON-ACKLAND</b> ,MouthGags	617
<b>FERRIS-SMITH</b> ,Rongeurs	532
SeptumForceps	595
TissueForecps	105
<b>FERRIS-SMITH-KERRISON</b> ,AntrumPunch	598
Rongeurs	526-527
Fine,Forceps	107
OperatingScissors	51-54
Scissors	51-54
Scissors, <b>SuperCut</b>	35
Finger,Goniometers	5
Protectors	619
RingCutters	309
<b>FINK</b> ,EyeHooks	471
<b>FINOCCHIETTO</b> ,GallDuctClamps	133
LobectomyScissors	61
NeedleHolders	231
NeedleHolders <b>TC</b>	239
RibSpreaders	413,419
<b>FINOCCHIETTO-BABY</b> ,RibSpreaders	413
<b>FINOCCHIETTO-BABY-HAIGHT</b> , RibSpreaders	418
<b>FINOCCHIETTO-BURFORD</b> ,RibSpreader	413
<b>FINSEN</b> ,Retractors	190
<b>FINSTERER</b> ,SuctionandIrrigationCannulas	12

## F

	Pages#		Pages#
<b>FISCH</b> ,CrurotomyForceps	576	Tubing	144
MicroDissectors	581	TwinClamps	341,343
<b>FISCHER</b> ,IrisForceps	496	Vaginal	138-139
TonsilKnives	621	Watchmarkers	106,504
TendonStrippers	322	<b>FORD</b> ,Stethoscopes	1
<b>FISCHER-ARIT</b> ,IrisForceps	496	<b>FORD-DIXON</b> ,HaemorrhoidalLigators	351
<b>FISH</b> ,Probes	210	Foreign,BodyChisels	470
Fistula,Hooks	390	BodyCurettes	476-477
Knives	26	BodyLeverInstruments	586
Probes	211	BodyForceps	365
Scissors	50	BodyGouges	485-486
Fixation,DiscsForExtensionBows	318	Needles	485-486
DiscsforWiresDrills	318	<b>FOREGGER</b> ,Laryngoscopes	18
Forceps	496-497	<b>FORSTER</b> ,SwabHoldingForceps	148
Forks	469	<b>FOX</b> ,LupusCurettes	329
Flap,Knives	27	<b>FRAENKEL</b> ,LaryngealPolypusForceps	631
<b>FLATAU</b> ,Tips	629	NasalSpeculas	589
<b>FOERSTER</b> ,IrisForceps	494	Tips	629
SpongeHoldingForceps	146	TongueDeressors	618
<b>FOMON</b> ,Chisels	604	<b>FRANCIS</b> ,ForeignBodyNeedles	469
NasalRasps <b>TC</b>	606-607	<b>FRANKFELDT</b> ,CottonApplicators	213
NasalScissors	63	<b>FRANZ</b> ,AbdominalRetractors	209
NasalScissors,SuperCut	37	<b>FRAZIER</b> ,AbdominalRetractors	202
Retractors	610	Elevators	517
RhinoplasticHooks	609-610	Hooks	609
Forceps,Advancements	490-491	NerveRetractors	525
AnastomosisClamps	428,438,442,446	Retractors	150
AneurysmClamps	430-431,443	SuctionTubes	9-10
AnteriorChamber	492	<b>FREER</b> ,Chisels	602
Aortic	432,453-456	RhinoplasticHooks	609
Atrauma	111-423	RhinoplasticKnives	600
Auricle	433	SeptumElevators	601
Blindgut	339	<b>FREER-YASARGIL</b> ,SeptumElevators	601
BloodVessel	421-422	<b>FRIEDMANN</b> ,BoneRongeurForceps	299
Bronchus	127,421	<b>FRIEDMANN-DELICATE</b> ,BoneRongeurForceps	300
Bulldog	115,149	<b>FRITSCH</b> ,Retractors	175
Capsular	496-498	<b>FRYKHOLM</b> ,BoneRongeurForceps	306
Cardiovascular	421-455	<b>FUCHS</b> ,CapsularForceps	498
Chalazion	500	IrisForceps	496
Cilia	109-110	<b>FUCHSIG</b> ,HemostaticForceps	123
ClipApplying	255		
Coarctation	443,449	<b>G</b>	
Conjunctival	495	Gall,DuctandCysticForceps	355
CoverGlass	110	DuctClampForceps	133-134,137
DissectingandLigature	124,128,134	DuctDuctForceps	355
Dressing	95-99	DuctStoneForceps	356
Ear	111,568	DuctStoneProbes	357
Entropium	491	DuctStoneScoops	358-359
Fine	107	<b>GARDNER</b> ,Mallet	321
Fixation	496-497	<b>GARDLAND</b> ,ClampForceps	137
GallDuctandCystic	355	<b>GAUSS</b> ,ScalpFlapForceps	407
Haemorrhoidal	115,136	GauzePackers	620
Hemostatic	115-127	<b>GELLHORN</b> ,CervicalBiopsyandSpecimenForceps	393
Hysterectomy	135-138	<b>GELPI</b> ,AbdominalRetractors	200
IntestinalClamps	335-337,339	<b>GERMINI</b> ,DissectingandLigatureForceps	131
Iris	492-497	<b>GERALD</b> ,DressingForceps	98
KidneyPedicleClamps	352-353	TissueForceps	104
Ligature	109,435,-436	<b>GERBORE</b> ,AorticDilators	457
MultiPurpose	441,446	<b>GERZOG</b> ,Mallets	321
Muscle	327,490-491	<b>GERZOG-SEXTON</b> ,Knives	586
NailTearingoutToeandFingerNails	309	<b>GIERTZ-STILLE</b> ,RibShears	412
Nasal	593-594	Gigli,Saws	506
Neonatal	454-455	SawsHandles	506
Parametrium	135	<b>GIL-VERNET</b> ,Retractors	154
Penis	365	<b>GILL</b> ,CornealKnives	468
Pressure	137	IrisForceps	496
Profunda	446	<b>GILL-ARRUGA</b> ,CapsularForceps	497
ScalpFlap	138	<b>GILL-HESS</b> ,IrisForceps	496
Sinus	145	<b>GILLIES</b> ,CutaneousHooks	150,329
Splinter	107-108	NeedleHolders	233
Sterilizing	632	NeedleHolderswithScissors <b>TC</b>	243
StomachClamps	340-341,343	Retractors	150
Strabismus	489-490	TissueForceps	103
Suture	488-489	<b>GILLIES-SLIM</b> ,NeedleHolders	243
TangentialOcclusion	437	<b>GILLS-WELSH</b> ,IrrigationandAspirationCannulas	479
Tendon	322-324	<b>GLOVER</b> ,AnastomosisClamps	428,437,442
Tissue	100-106,502	AtraumaBulldogClamps	425
Towel	142-143	<b>GOELET</b> ,Retractors	160
Trachoma	500		

## G

	Pages#
Goitre, Grasping Forceps	372
Instruments	327
Probes	327
<b>GLUCK</b> , Rib Shears	90
<b>GOLDMAN-FOX</b> , Gum Scissors	64, 92
<b>GOLDSTEIN</b> , Eye Speculas	460
Goniometers	5
Goniotomy Knives	469
<b>GOOD</b> , Tonsil Scissors	61
<b>GOODELL</b> , Uterine Dilators	381
<b>GOSSET</b> , Abdominal Retractors	201-202
Gouges	258-264, 603
<b>GOURDET</b> , Uterine Curettes	399
<b>GRADLE</b> , Cilia Forceps	109
<b>GRAEFE</b> , Cataract Knives	468
Cataract Spoons	475
Corneal Scarifiers	473
Cystotomes	470
Eye Scissors	83
Eye Speculas	461
Fixation Forceps	502
Iris Forceps	494-495
Iris Hooks	471
Iris Knives	464
Lens Hooks	475
Skin Hooks	151
Strabismus Hooks	472
<b>GRAEFE-ARRUGA</b> , Cataract Knives	464
<b>GRAETHER</b> , Collar Bottom Cannulas	482
<b>GRAHAM</b> , Nerve Retractors	525
Grasping Forceps	105-106, 112, 534
<b>GRAVE</b> , Vaginal Speculas	367-368
Vaginal Speculas For Laser Surgery	368
<b>GRAY</b> , Gall Duct Forceps	355
<b>GRAZIL</b> , Operating Scissors	40
<b>GREEN</b> , Corneal Dissectors	470
Double Spatulas	485
Eye Muscle Hooks	471
Fixation Forceps	504
Retractors	172
<b>GREEN-ARMYTAGE</b> , Uterine Haemostasis Forceps	406
<b>GREENE</b> , Uterine Curettes	400
<b>GREGORY</b> , Profunda Clamps	446
<b>GREGORY-SOFT</b> , Bulldog Clamps	426
<b>GREVEN</b> , Ear Polypus Forceps	573
<b>GROSS</b> , Foreign Body Instruments	586
<b>GROSS-MAIER</b> , Polypus and Dressing Forceps	146
<b>GRUBER</b> , Ear Speculas	565
<b>GRUENWALD</b> , Dressing Forceps	99
Nasal Cutting Forceps	596
<b>GRUENWALD(JANSEN)</b> , Nasal Dressing Forceps	593
<b>GUEDEL-NEGUS</b> , Laryngoscopes	19
Gum Scissors	64, 92-94
<b>GUTHRIE</b> , Double Fixation Hooks	472
Skin Hooks	151
<b>GUTTMANN</b> , Secretion Scoops	366
<b>GUYON</b> , Catheter Introducing Instruments	364
Atrauma Kidney Pedicle Clamp	352
Forceps	352
Kidney Pedicle Clamps Forceps	352-353
<b>GUYON-LUNDGAARD</b> , Sclerotomy	469
Gynecological Instruments	364-404
Gynecological Scissors	49-50

## H

<b>HABERER</b> , Abdominal and Intestinal Spatulas	180
Intestinal and Stomach Clamps Forceps	343
Haemorrhoidal, Clamps	115, 136
Forceps	349-351
Ligators	350-351
<b>HAGLUND-STILLE</b> , Plaster Spreaders	256
<b>HAIGHT</b> , Rib Spreaders	415
<b>HAJEK</b> , Mallets	320
Nasal Cutting Forceps	596
<b>HAJEK-KOFLER</b> , Laminectomy Rongeurs	537
Septum Forceps	597-598
<b>HALLE</b> , Bone Curettes	270
Nasal Scissors	63
Septum Elevators	601

	Pages#
<b>HALSEY</b> , Needle Holders	229
<b>HALSTEAD-MOSQUITO</b> , Hemostatic Forceps	117-118
<b>HAMBURG</b> , Eye Knives Lanced Form	467
<b>HAMILTON-BAILY</b> , Irrigating Cannulas	15
<b>HANK</b> , Uterine Dilators	380
<b>HANKEN</b> , Auricle Clamps	433
Blood Vessel Clamps	422
<b>HARDY</b> , Dissectors	552
Pituitary Curettes	560
<b>HARDY-FAHLBUSCH</b> , Dissectors	552
<b>HARM</b> , Lachrymal Probes	484
<b>HARRINGTON</b> , Retractors	178
<b>HARRINGTON-BABY</b> , Retractors	178
<b>HARRINGTON-PEMBERTON</b> , Retractors	178
<b>HARTMANN</b> , Bone Rongeur Forceps	300
Ear Catheters	568
Ear Hooks	586
Ear Polypus Forceps	570-571
Ear Speculas	564-566
Hemostatic Forceps	117
Nasal Cutting Forceps	596
Nasal Polypus Forceps	594
Nasal Speculas	589-592
Tongue Depressors	618
Tonsil Punch Forceps	625
Tuning Forks	567-568
Wash Cannulas	614
<b>HARTMANN-CITELLI</b> , Ear Polypus Forceps	571
<b>HARTMANN-HALLE</b> , Nasal Speculas	590
<b>HARTMANN-NOYES</b> , Ear Polypus Forceps	571
<b>HARTMANN-WEINGARTNER</b> , Ear Polypus Forceps	571
<b>HARTMANN-WULLSTEIN</b> , Ear Polypus Forceps	571
<b>HARVEY</b> , Wire Cutting Scissors	87
<b>HASLINGER</b> , Uvula Retractors	622
<b>HAYES</b> , Atrauma Sidmiod Anastomosis Forceps	336
Head Extractors	407
Head Lamps	4
<b>HEANEY</b> , Hysterectomy Forceps	135
Needle Holders	230
Retractors	179
Uterine Curettes	400
<b>HEANEY-BALLENTINE</b> , Hysterectomy Forceps	136
<b>HEANEY-SLIM</b> , Hysterectomy Forceps	135
<b>HEATH</b> , Ligature Scissors	86
Mallets	320
<b>HEBRA</b> , Chalazion Curettes	476
Comedone Extractors	328
<b>HEGAR</b> , Needle Holders	230
Uterine Dilators	379
<b>HEGAR-BAUMGARTNER</b> , Needle Holders	229
Needle Holder TC	236
<b>HEGAR-VASCULAR</b> , Needle Holders	238
<b>HEGEMANN</b> , Vascular Scissors	58
<b>HEGENBARTH</b> , Clip Applying Forceps	255
<b>HEIFETZ</b> , Brain Spatulas	520
<b>HEISS</b> , Dissecting and Ligature Forceps	130
<b>HEISTER</b> , Mouth Gags	617
<b>HELFERRICH-BIER</b> , Amputation Saws	310
Hemilaminectomy Retractors	197
Hemostatic Forceps	115-127
<b>HENLEY</b> , Retractors	193
Discectomy Retractors	516
<b>HENKE</b> , Tonsil Elevators	622
<b>HENNER(LEMPERT)</b> , Retractors	192
<b>HENNING</b> , Plaster Spreaders	256
<b>HENRY</b> , Cilia Forceps	109
<b>HEPP-SCHIEDL</b> , Micro Needle Holders TC	227
<b>HERRICK</b> , Kidney Pedicle Clamp Forceps	353
<b>HERTZLER</b> , Retractors	202
<b>HESS</b> , Capsular Forceps	497
Iris Forceps	492
Lens Expressors	475
<b>HEY</b> , Discectomy Retractors	514
<b>HEY-GROVES</b> , Bone Holding Forceps	294
<b>HEYMANN</b> , Nasal Scissors	63
Nasal Scissors, SuperCut	37
Polypus Forceps	594
<b>HEYWOOD-SMITH</b> , Bone Hemorrhoidal Forceps	349
Uterus Polypus Forceps	388



## H

	Pages#
<b>HIBBS</b> , Bone Chisels	263
Gouges	263
Osteotomes	263
Retractors	179
<b>HIRSCHMANN</b> , Anusscopes	345
Eye Spatulas	474
Iris Hooks	471
<b>HOEN</b> , Elevators	282, 517
Nerve Retractors	524
<b>HOESEL</b> , Needle Holders TC	242
Retractors	170
<b>HOFER</b> , Tonsil Retractors	622
<b>HOFFER</b> , Marking Instruments	487
<b>HOFFMANN</b> , Tubing Forceps	144
<b>HOHMANN</b> , Bone Levers	285-286
<b>HOHMANN-ALDINGER</b> , Bone Levers	287
<b>HOKE</b> , Osteotomes	260
<b>HOLSHER</b> , Nerve Root Retractors	522
<b>HOLZBACH</b> , Hysterectomy Forceps	137
<b>HOLZHEIMER</b> , Retractors	191
Hooks, Autopsy	31
Handles	506
Wood and Nerve	150-151
<b>HOPKIN</b> , Plaster Knives	256
<b>HORSLEY</b> , Elevators	519
Hose Connecting Pieces	401
<b>HOSOBUCHI</b> , Spatulas	561
<b>HOUGH</b> , Micro Forceps	573
<b>HOUSE</b> , Micro Hooks	581
Micro Spoons	582
Suction Tubes	568
<b>HOWARD</b> , Septum Elevators	601
<b>HUBER</b> , Universal Handles	628
<b>HUDSON</b> , Bone Hand Drills	311
Conical and Spherical Burrs	311
<b>HUMBY</b> , Retractors	153
<b>HUNTER</b> , Splinter Forceps	108
<b>HURD</b> , Tonsil Elevators	622
Tonsil Needles	620
<b>HYLIN</b> , Periosteal Raspatories	277
Hysterectomy Forceps	135-138

## I

Incision Scissors	42
<b>INGE</b> , Lamina Spreaders	513
Inhalers	14
Instrumentation For D. B. Kirby	486
Instruments For Brain Suture	508
For Cranial Opening	506
For Radial Keratotomy	487
Interchangeable Tips	629
Interosseous Knives	27
Intervertebral Disc Rongeur	526-529
Intestinal and Stomach Clamps	340-341, 343
and Stomach Twin Clamp Forceps	341-343
Clamp Forceps	335-337, 339
Tissue Forceps	330-331
<b>IOWA</b> , Pelvimeters	405
Tenaculum Forceps	388
Iridectomy Scissors	65-69
Iris, Forceps	492-497
Hooks	471
Knives	468
Scissors	53
Scissors <b>SuperCut</b>	35
Spatulas	473-474, 485
Irrigating, Cannulas	478
Vectis Cannulas	479
Aspiration Cannulas	479
<b>ISRAEL</b> , Retractors	166
<b>ITERD</b> , Ear Catheters	568
<b>ITERTSON</b> , Wound Retractors	156
<b>IVES-FANSLER</b> , Anusscopes	316

## J

Wound Retractors	153, 156
<b>JACKSON</b> ,	

	Pages#
Vaginal Speculas	370
<b>JACOBI</b> , Eye Ligature Needles	505
<b>JACOBS</b> , Tenaculum Forceps	388
<b>JACOBSON</b> , Bone Curettes	271
Micro Needle Holders	228
Micro Needle Holders TC	217
Micro Probes	544
Micro Scissors	73
Micro Suture Pusher and Knot Tiers	544
Micro Vessel Needles	541
Micro Vessel Probes	544
<b>JACOBSON-ADSON</b> , Dressing Forceps	96
Hemostatic Forceps	124
<b>JACOBSON-HALSTEAD</b> , Hemostatic Forceps	117
<b>JAEFE</b> , Eye Speculas	474
<b>JAEGER</b> , Eye Hooks	471
Keratomes	465
Lid Plates	463
<b>JAEGER-GRIESHABER</b> , Keratomes	465
<b>JAMESON</b> , Needle Holders	231
Scissors	52
Scissors, <b>SuperCut</b>	35
Strabismus Forceps	490
Strabismus Hooks	471
<b>JANNETTA</b> , Micro Dissectors, Elevators	546
Micro Surgery Instruments	546
<b>JANSEN</b> , Bone Curettes	271
Bone Rongeur Forceps	301-302
Capsular Polishing Cannulas	481
Dressing Forceps	569
Ear Forceps	111
Head Lamps	4
Nasal Forceps	111
Periosteal Raspatories	275
Retractors	191
Spoons	585
Tissue Forceps	111
<b>JANSEN-DEEP</b> , Retractors	191
<b>JANSEN(GRUENWALD)</b> Ear Forceps	111
Nasal Forceps	111, 593
<b>JAVID</b> , Carotid Clamps	448
<b>JEFFE-KNOLLE</b> , Iris Hooks	471
<b>JENNING</b> , Mouth Gags	617
<b>JOBSEN-HORNE</b> , Cotton Applicators	212
<b>JOHNS-HOPKINS</b> , Applying Forceps	115
Bulldog Clamps	115
Dissecting and Ligature Forceps	128
<b>JONES</b> , Towel Forceps	142
<b>JOSEPH</b> , Nasal Rasps	608
Nasal Saws	605
Periosteal Elevators	601
Raspatories	602
Rhinoplastic Hooks	609
Rhinoplastic Knives	599
Scissors	54
Septum Elevators	601
<b>JOSEPH-COTTLE</b> , Septum Forceps Elevators	602
<b>JUDD-ALLIS</b> , Intestinal Tissue Forceps	331
<b>JUDD-MASSON</b> , Bladder Retractors	361-362
<b>JUERS</b> , Micro Forceps	573
<b>JURASZ</b> , Adenoid Cutting Forceps	599
Laryngeal Polypus Forceps	631

## K

<b>KADER</b> , Abdominal and Intestinal Spatulas	180
<b>KALLMORGEN</b> , Vaginal Speculas	374
<b>KALT</b> , Capsular Forceps	498
Micro Needle Holders	225
Micro Needle Holders TC	227
<b>KALT_ARRUGA</b> , Micro Needle Holders	225
<b>KANTROWITZ</b> , Hemostatic Forceps	127
<b>KATSCH</b> , Comedone Extractors	328
<b>KATZIN</b> , Iridectomy Scissors	68
<b>KATZIN-BARRAQUER</b> , Iridectomy Scissors	68
<b>KAZANJIAN</b> , Bone Cutting Forceps	308
Septum Forceps	597
<b>KELLY</b> , Fistula Scissors	50



## K

	Pages#
Hemostatic Forceps	118, 126
Proctoscopes	316
Retractors	173-174, 176
Sphincteroscopes	346
<b>KELLY-RANKIN</b> , Hemostatic Forceps	118
<b>KELSEY-FRY</b> , Awls	189
Keratomes	465-466
<b>KERN</b> , Bone Holding Forceps	295
<b>KERRISON</b> , Antrum Rongeurs	584
<b>KEVORKIAN</b> , Biopsy Curettes	392
Cervical Biopsy and Specimen Forceps	395, 398
<b>KEY</b> , Elevators	283
<b>KIDNEY</b> , Pedicle Clamp and Forceps	352-353
Stone Forceps	354
<b>KIELLAND</b> , Obstetrical Forceps	410
<b>KIELLAND-LUIKART</b> , Obstetrical Forceps	410
<b>KILLIAN</b> , Gouges	603
Laryngeal Polypus Forceps	631
Nasal Speculas	591
Septum Elevators	502
Wash Cannulas	614
<b>KILLIAN-CLAUS</b> , Gouges	603
<b>KILLIAN-DOUGHTY</b> , Mouth Gags	615
<b>KILNER</b> , Needle Holders <b>TC</b>	237
Retractors	150
Rhinoplastic Hooks	610
Scissors	55
Skin Hook	329
<b>KIRBY</b> , Capsular Forceps	486
Fixation Forceps	486
<b>KIRCH</b> , Cheek Retractors	182
<b>KIRSCHNER</b> , Abdominal Retractors	207
Extension Bows	317
Ligature Conductors	253
Traction Hooks For Extension Bows	318
Wire Strainers For Extension Bows	318
<b>KLAPP</b> , Tendon Sheath Hooks	158
<b>KLEINERT-KUTZ</b> , Bone Rongeur Forceps	303
Retractors	153
Tendon Passing Forceps	323
<b>KLEINSCHMIDT</b> , Blindgut Forceps	339
<b>KLINGENBERG-LOTH</b> , Vascular Scissors	57
<b>KNAPP</b> , Cataract Spoons	475
Discission Knives	467
Eye Hooks	472
Scissors	54
Trachoma Forceps	472, 500
<b>KNAPP-CLARK</b> , Eye Speculas	461
<b>KNAPP-ROLLET</b> , Eye Hooks	472
<b>KNIGHT</b> -Nasal Scissors	63
Knives, Amputation	27
Autopsy	28-29, 31
Brain	28
Capsulotomy	468
Cartilage	29
Cataract	464
Cone	390
Comeal	468
Discission	467
Eye	464-468
Fistula	26
Flap	27
Goniotomy	468
Interosseous	27
Iris	468
Meniscotomy	291
Moncorps	329
Myoma	390
Nerve Knives	525
Phalangeal	27
Plaster	256
Post Mortem	28
Pterygium	469
Ptosis	469
Resection	28
<b>KNOLLE</b> , Iris Hooks	471
<b>KNOLLE-KELMANN</b> , Cystotome Cannulas	479
<b>KNOLLE-PEARCE</b> , Irrigating Vectis Cannulas	480
Knot Tiers	254

	Pages#
<b>KNOWLES</b> , Bandage Scissors	89
<b>KOCHER</b> , Bladder Retractors	362
Bulb Headed Probes	327
Goitre Directors	327
Hemostatic Forceps	121
Intestinal Clamps Forceps	337
Ligature Needles	247
Retractors	164, 169-170, 175
<b>KOCHER-ATRAUMA</b> , Intestinal Clamp Forceps	337
<b>KOCHER-LANGENBECK</b> , Retractors	169
<b>KOCHER-WAGNER</b> , Retractors	283
<b>KOENIG</b> , Elevators	254
Ligature Conductors	276
Periosteal Raspatories	157
Retractors	166-167
<b>KOERTE</b> , Retractors	166
<b>KOERTE-WANGER</b> , Retractors	381
<b>KOGAN</b> , Endospeculas	381
<b>KOGAN-LASER</b> , Endospeculas	32
<b>KOLLE</b> , Microscope Needle Holders	541
<b>KOOS</b> , Micro Vessel Knives	480
<b>KRATZ</b> , Capsule Polishing Cannulas	479
Cystotome Cannulas	569
<b>KRAUSE</b> , Ear Polypus Snares	593
Nasal Snares	629
Tips	8
Trocars	529
<b>KRAUSE-VOSS</b> , Ear Polypus Forceps	569
Nasal Snares	593
<b>KRAYENBUL</b> , Ligature Guides	543
<b>KREMER</b> , Comeal Fixation Forceps	501
<b>KRESSNER</b> , Septum Punch Forceps	611
<b>KRISTELLER</b> , Vaginal Speculas	371-373
<b>KROENIG</b> , Tongue Depressors	618
<b>KROENLEIN</b> , Hemostatic Forceps	122
<b>KRONECKER</b> , Ligature Needles	247
<b>KUEHNE</b> , Cover Glass Forceps	110
<b>KUEMMEL</b> , Retractors	171
<b>KUHNT</b> , Comeal Scarifiers	468
<b>KWITKO</b> , Eye Spatulas	475
<b>L</b>	
<b>LABORDE</b> , Trachea Dilators	325
Lachrymal, Cannulas	481
Dilators	483-484
Probes	484
Sac Dissectors	477
Sac Hooks	470
<b>LAFORCE</b> , Foreign Body Instruments	470
Adenotome	613
<b>LAGANGE</b> , Eye Scissors	83
Gum Scissors	93
<b>LAHEY</b> , Gall Duct Clamps	134
Goitre Grasping Forceps	327
Retractors	168
<b>LAMBERT</b> , Chalazion Forceps	500
<b>LAMBERT-KAY</b> , Aortic Anastomosis Clamps	438
<b>LAMBOTTE</b> , Bone Holding Forceps	296-297
Bone Osteotomes	261
Periosteal Raspatories	282
Lamina Spreaders	509-513
Laminectomy Reongeurs	530-534, 536-537
<b>LANCASTER</b> , Eye Speculas	461
<b>LANDAU</b> , Trocars	7
Vaginal Speculas	377
<b>LANDOLT</b> , Enucleation Scissors	52
Pituitary Rongeurs	535
Scissors	52
<b>LANDOLT-REULEN</b> , Dissectors	562
Hooks	562
<b>LANE</b> , Bone Holding Forceps	297
Bone Levers	288
Stomach Clamps	341
Tissue Forceps	105
Towel Forceps	143
<b>LANE-TRETHOWAN</b> , Bone Levers	288



## M

	Pages#		Pages#
<b>MASS.-GENERAL HOSPITAL</b> , Elevators	282	<b>MICHEAL</b> , ClipApplyingForceps	225
NeedleHolders	231	LaryngealMirrors	630
<b>MASSON</b> , NeedleHolders	231	Micro, Currettes	554-555
NeedleHolders <b>TC</b>	239	Dissectors	542-547, 552, 556-559
<b>MASTIN</b> , MuscleForceps	327	EarPolypusForceps	572-576
<b>MATHIEU</b> , ForeignBodyForceps	365	Elevators	542
NeedleHolders	234	Forceps	572-576
NeedleHolders <b>TC</b>	240, 272	Hooks	546-547, 550, 556
RectalSpeculas	344	Instruments	538-563, 572-583
Retractors	161	InstrumentswithFingerGrip	543
VaginalSpeculas	375	Knives	548
<b>MATHIEU-KOCHER</b> , NeedleHolders <b>TC</b>	241	LaryngealCupForceps	626
<b>MATHIEU-RYDER</b> , NeedleHolders <b>TC</b>	240	LaryngealForceps	626
<b>MATSON</b> , PeriostealRaspatories	277	LaryngoScissors	626
<b>MATZNAUER</b> , VaginalSpeculas	375	LigatureNeedles	547, 549, 551
<b>MAYFIELD</b> , BoneRongeurForceps	303	MeasuringRoad	581
<b>MAYO</b> , GallStoneScoops	359	Mobilizers	581
GraspingForceps	105	Needles	579-580
TongueDepressors	618	NeedleHolders	216-226
Scissors	43	NeedleHolders <b>TC</b>	226
Scissors, <b>SuperCut</b>	34	NerveHooks	543-545-547, 550-551, 556
Scissors, <b>TC</b>	43	Raspatories	549, 553, 556
SterilizingClamps	632	Scissors	70-79, 573-575, 577
<b>MAYO-ADAMS</b> , AbdominalRetractors	199	Scoops	556
<b>MAYO-BLAKE</b> , GallStoneForceps	356	VesselDilators	544
<b>MAYO-COLLIN</b> , Retractors	161	VesselKnives	541
<b>MAYO-GUYON</b> , KidneyPedicleClamp, Forceps	353	<b>MICRO-ADSON</b> , DressingForceps	96
<b>MAYO-HEGAR</b> , NeedleHolders	230	TissueForceps	102
NeedleHolders <b>TC</b>	236	<b>MICRO-MOSQUITO</b> , HemostaticForceps	117
<b>MAYO-NOBLES</b> , Scissors	44	Microscopic, Instruments	32
<b>MAYO-ROBSON</b> , AtraumalIntestinalClamp, Forceps	335	NeedleHolders	32
<b>MAYO-STILLE</b> , Scissors	43	Needles	32
Scissors, <b>SuperCut</b>	34	Scissors	84
Scissors, <b>TC</b>	43	<b>MIDDELDORPF</b> , Retractors	172
<b>McCULLOUGH</b> , StrabismusForceps	489	<b>MIDDLE-JANSEN</b> , SeptumForceps	597
<b>McDONALD</b> , Elevators	283	<b>MIKULICZ</b> , IntestinalClampForceps	140-141
<b>McGANNEN</b> , IrisHooks	471	PeritonealClampForceps	140-141
<b>McGEE</b> , MicroHooks	580	Retractors	176
WireClosureForceps	576	<b>MILAN</b> , UterineCurrettes	401
<b>McGEE-FISCH</b> , WireClosureForceps	576	<b>MILLER</b> , BoneRasps	607
<b>McGIVEN</b> , HaemorrhoidalForceps	351	Retractors	150
HaemorrhoidalLigators	351	<b>MILLER-BABY</b> , Laryngoscopes	19
<b>McINDOE</b> , BoneCuttingForceps	307	<b>MILLES</b> , MicroScissors	75
CartilageScissors	57	<b>MILLIGAN</b> , Retractors	193
DressingForceps	96	Elevators	519
<b>McINTOSH</b> , Laryngoscopes	16	<b>MILLIN</b> , BladderRetractors	361
<b>McIVOR</b> , MouthGags	615	ProstaticLobeHoldingForceps	360
<b>McLEAN</b> , ObstetricalForceps	410	SuctionTubes	13
<b>McKENTY</b> , SeptumElevators	601	<b>MILLS</b> , NeurosurgicalScissors	84
<b>McKENZIE</b> , ApplyingForceps	508	<b>MILLIS</b> , MicroScissors	75
<b>McPHERSON</b> , SutureForceps	488	<b>MINI-FRIEDMANN</b> , BoneRongeurForceps	299
<b>McQUIGG-MIXTER</b> , GallDuctClamps	133	<b>MINI-GEMINI</b> , DissectingandLigature, Forceps	132
<b>MEAD</b> , BoneRongeurForceps	301	<b>MINI-HOHMANN</b> , BoneLevers	284
Mallets	321	<b>MINI-LAMBOTTE</b> , BoneOsteotomes	261
<b>MEEKER</b> , DissectingandLigatureForceps	31	<b>MINI-LANGENBECK</b> , Retractors	152
<b>MELLINGER</b> , EyeSpeculas	460	<b>MINI-LEXER</b> , BoneChisels	261
<b>MELLINGER-AXENFELD</b> , EyeSpeculas	460	BoneGouges	261
<b>MELLINGER-BEARD</b> , EyeSpeculas	461	<b>MINI-ROUX</b> , Retractors	160
MeniscotomyKnives	291	<b>MINI-TOWNSEND</b> , CervicalBiopsyandSpecimenForceps	398
Meniscus, Knives	291	MirrorHandles	563
Retractors	290	Mirrors	563
<b>MERCEDES</b> , ThoracicRetractors	417	<b>MITCHELL</b> , Cannulas	15
<b>MERSHON</b> , BandPushers	189	<b>MIXTER</b> , DissectingandLigatureForceps	132-133
Messer	578	Scissors	132
MetalCatheters	364	<b>MIXTER-SHAUGHNESSY</b> , DissectingandLigatureForceps	132
HandlesForLaryngealMirrors	630	<b>MIXTER-SLIM</b> , DissectingandLigatureForceps	132
SupportForEarSpeculas	566	Scissors	62
<b>METZENBAUM</b> , DissectingScissors	44-48	<b>MOD.USA</b> , UmbilicalScissors	48, 62
DissectingScissors <b>TC</b>	44-48	<b>MOLTGEN</b> , Goniometers	591
Scissors, <b>SuperCut</b>	34	<b>MOHR</b> , TubingForceps	5
<b>METZENBAUM-FINE</b> , DissectingScissors	44-48	<b>MOLLISON</b> , Retractors	144
Scissors <b>SuperCut</b>	34	<b>MOLT</b> , MouthGags	192
<b>MEYER</b> , ForeignBodyGouges	470	<b>MOLT-BABY</b> , MouthGags	616
<b>MEYER, SCHWICKERATH</b> , Locators	471	<b>MONCORPS</b> , Knives	616
<b>MEYERDING</b> , AbdominalRetractors	200	<b>MOORE</b> , GallBladderScoops	329
Retractors	156, 179	<b>MOOREFIELD</b> , SutureForceps	359
<b>MEYHOEFER</b> , ChalazionCurrettes	476		

## M

	Pages#
<b>MORITZ-SCHMIDT</b> , TongueDepressors	503
<b>MORRIS</b> , Retractors	617
<b>MORRIS-DE-BAKEY</b> , AorticAnastomosis, Clamps	171
<b>MORRIS-FAVALORO</b> , RibSpreaders	442
<b>MOSQUITO</b> , AtraumaHemostaticForceps	417
<b>MOSQUITO-DANDY</b> , HemostaticForceps	444
MouthGags	122
<b>MOYNIHAN</b> , GallDuctClamps	615-617
<b>MUCK</b> , Knives	137
<b>MUELLER</b> , EyeSpeculas	586
<b>MUENCHEN</b> , BiopsyCurettes	462
<b>MULDOON</b> , EyeSpeculas	391
MultiposeClamps	484
<b>MURDOCK</b> , EyeSpeculas	441, 446
<b>MURLESS</b> , HeadExtractors	462
<b>MURPHY</b> , Retractors	407
<b>MURPHY-LANE</b> , BoneLevers	165
Muscle, Forceps	289
Hooks	327, 490-491
Retractors	31
<b>MUSEUX</b> , TenaculumForceps	514-515
TonsilSeizingForceps	387
<b>MYERS</b> , VeinStrippers	623
<b>MYLES</b> , NasalCuttingForceps	214
Myoma, Knives	596
Screws	390
MyrtleBladeProbes	390
	210
	214
<b>NABATOFF</b> , VaricoseVeinProbeSet	214
<b>NAEGELE</b> , ObstetricalForceps	407
Perforators	409
<b>NAGER</b> , TonsilElevators	622
TonsilNeedles	620
TonsilRetractors	622
Nail, Instruments	309
Nippers	633
Scissors	94
SplittingScissors	87
Nasal, Cannulas	1
Curettes	612
CuttingForceps	596
Knives	599-600
Rasps	606-608
Saws	605
Scissors	63
Snare	593
Speculas	589-592
Needle, Holders	229-234
Holders <b>TC</b>	235-242
HolderswithScissors	232-233
HolderswithScissors <b>TC</b>	243
Holders, Micro	216-226
Micro <b>TC</b>	227-228
<b>NEFF</b> , BoneHoldingForceps	292
MeniscotomyKnives	281
<b>NEGUS</b> , AdenoidCurettes	612
ArteryForceps	136
<b>NEIVERT</b> , NeedleHolders <b>TC</b>	235
<b>NEIVERT-MASING</b> , RhinoplasticHooks	609
<b>NELATON</b> , Probes	210
<b>NELSON</b> , GraspingForceps	106
Trocars	8
NeontalClamps	454-455
NephrostomyForceps	354
NerveandVesselsHooks	543
DissectingScissors	60
Hooks	551
Retractors	522, 525
RootRetractors	521-523
<b>NEUBUESER</b> , MicroScissors	98
<b>NEUMANN</b> , GumScissors	93
NeuroandLaminectomyInstruments	506-536
NeuroSurgical, Scissors	84
<b>NEVYAS</b> , CystotomeCannulas	479
<b>NEWORLEANS</b> , LensScoops	475

	Pages#
NeedleHolders	229
NeedleHolders <b>TC</b>	235
<b>NEWSUTURE</b> , Scissors	42
<b>NICATI</b> , ForeignChisels	470
<b>NICOLA</b> , PituitaryCurettes	560
PituitaryInstruments	560-561
<b>Nicro</b> , GumScissors	92
<b>NISSEN</b> , GallDuctForceps	355
HemostaticForceps	124
<b>NORTHBENT</b> , LigatureScissors	85
<b>NORWOOD</b> , RectalSnare	349
<b>NOTO</b> , UterusPolypusForceps	388
<b>NOTT</b> , VaginalSpeculas	370
<b>NOVAK</b> , BiopsyCurettes	391
<b>NOVAK-SCHOEKAERT</b> , BiopsyCurettes	391
<b>NOYES</b> , IridectomyScissors	65
<b>NUBER</b> , SuctionTubes	4
<b>NUGENT</b> , StrabismusForceps	489
<b>NUSSBAUM</b> , IntestinalClampForceps	339
StomachClampForceps	343

## O

<b>OCONNOR</b> , ConjunctivalForceps	495
IrisHooks	47
NerveHooks	151
<b>O'SULLIVAN-O'CONNOR</b> , Abdominal, Retractors	208
VaginalSpeculas	378
ObstetricalForceps	410-411
ObstetricsInstruments	405-411
<b>OCHSNER</b> , AorticClamps	432
LigatureForceps	109
Trocars	8
<b>OCHSNER-KOCHER</b> , HemostaticForceps	121
<b>OEHIEF</b> , TissueForceps	100
<b>OLDBURG</b> , NerveRootRetractors	523
PituitaryRongeurs	535
<b>OLIVECRONA</b> , BoneRongeurForceps	300
BrainSpatulas	520
Dissectors	519
Elevators	519
TrigeminalScissors	64
WireSaws	506
<b>OLIVECRONA-TONNIS</b> , ApplyingandRemovingForceps	508
<b>OLLIER</b> , Retractors	169
<b>OLSEN-HEGAR</b> , NeedleHolders	232
NeedleHolders <b>TC</b>	243
<b>OKONOGTO</b> , EarPolypusForceps	570
<b>OMBREDANNE</b> , Mallets	320
OperatingKnives	22-25, 38-40
OperatingScissors	38-40, 42-44
OperatingScissors, SuperCut	34
OperatingScissors, <b>TC</b>	38-39, 43
OphthalmologyInstruments	459-505
OralInstruments	615-619
Orbit Spatulas	473
OrganGraspingForceps	332
OtologyInstruments	564-588
Osteotomes	258, 260-263
OsteotomesForAnatomyandAutopsy	31
OsteotomesForMaxillofacialSurgery	188
OvarianForceps	390
<b>OVERHOLT</b> , DissectingandLigatureForceps	129
PeriostealRaspatories	277
<b>OVERHOLT-GEISSENDOERFER</b> ,	130
DissectingandLigatureForceps	130
<b>OVERHOLT-MIXTER</b> , DissectingandLigaturebForceps	130
<b>OVERHOLT-SLIM</b> , DissectingandLigatureForceps	129

## P

<b>PACIFIC-KEVORKIAN</b> , Cervicaland LigatureForceps	397
<b>PAPST</b> , RoundKeratome	466
Parametrium, Forceps	135
Scissors	62
<b>PARK</b> , AnalRetractors	347

## P

	Pages#
EyeSpeculas	459
<b>PARK-GUYTON</b> ,EyeSpeculas	459
<b>PARK-MAUMENEE</b> EyeSpeculas	459
<b>PARKER</b> ,Retractors	160
<b>PARKER-LANGENBECK(US-ARMY)</b> , Retractors	160
<b>PARKER-MOTT</b> ,Retractors	161
<b>PARKES</b> ,Rasps <b>TC</b>	607
<b>PARTSCH</b> ,BoneChisels	258
BoneGouges	258
Mallets	321
<b>PASSOW</b> ,BoneChisels	258
Levers	255
PatellaForceps	298
<b>PATON</b> ,CornealDissectors	468
MicroNeedleHolders	217
<b>PATTERSON</b> ,CervicalBiopsyand SpecimenForceps	394
<b>PAUFIQUE</b> ,SutureForceps	489
<b>PAUL</b> ,EyeRetractors	473
<b>PAYR</b> ,IntestinalClamps	340
LigatureConductors	251
<b>PEAN</b> ,HemostaticForceps	116,121
Trocars	7
<b>PEDERSON</b> ,VaginalSpeculas	369
PediatricClampsAtrauma	454
<b>PEERS-BERTRAM</b> ,TowelForceps	142
<b>PEET</b> ,SplinterForceps	108
<b>PELKMANN</b> ,Polypus Forceps	146
<b>PELTONSON</b> ,CottonApplicators	211
Pelvimeters	405
<b>PENFIELD</b> ,Elevators	517
PenisClamps	365
<b>PENNINGTON</b> ,HemostaticForceps	116
Raspatories	602
PercussionHammers	2-3
<b>PERCY</b> ,Retractors	296
Perforators	407
Periosteal,Raspatories	274-281
Peritoneal,ClampandForceps	140-141
<b>PERTHES</b> ,Reamers	312
Phalangeal.Knives	27
<b>PIERCE</b> ,SeptumElevators	602
Trocars	8
<b>PIFFARD</b> ,SkinHooks	328
<b>PINARD</b> ,Stethoscopes	1
<b>PINMED</b> ,RazorBladeBreakers	30
SwedishPatt.NeedleHolders <b>TC</b>	238
<b>PIPER</b> ,OstreticalForceps	411
Pituitary,Cupped-ShapedForceps	538-539
Curettes	559-560
Dissectors	562
Enucleators	561
Forceps	538-539
Hooks	561-562
Instruments	538-540,559-562
Raspatories	549,553
Rongeurs	535
Scissors	538-540
Scoops	562
Spatulas	561
Speculas	563
PlacentaandOvumForceps	406
<b>PLANGE</b> ,ForeignBodyNeedles	470
Plaster,CastForceps	257
Knives	256
ofParisShears	90
Saws	256
Scissors	90
Spatulas	211
Spreaders	256
PlasticSurgeryScissors, <b>SuperCut</b>	35
<b>PLESTER</b> ,MicroKnives	578
Retractors	191
SuctionTubes	10
<b>PLEY</b> ,EyeSpeculas	461
<b>POLITZER</b> ,EarSpeculas	564
Knives	586-587
<b>POLLOSON</b> ,Retractors	177

	Pages#
<b>POOLE</b> ,SuctionTubes	12
PostMortemKnives	28
PostMortemNeedles	32
<b>POTTS-DeMARTEL</b> , NeuroSurgicalScissors	8499
<b>POTTS-SMITH</b> ,DressingForceps	36
Scissors, <b>SuperCut</b>	55-57
VascularScissors	56
VascularScissors, <b>TC</b>	385
<b>POZZI</b> ,TenaculumForceps	211
<b>PRATT</b> ,FistulaProbes	115
HaemorrhoidalClamps	344
RectalSpeculas	387
TenaculumForceps	380
UterineDilators	293
<b>PRESTON</b> ,BoneHoldingForceps	421
<b>PRICE-THOMAS</b> ,BronchusClamps	490
<b>PRINCE</b> ,MuscleHooks	60
TonsilScissors	210-211
Probes,	210-211
BulbHeaded	211
Fistula	214
ForVaricoseVeins	357
GallDuct	357
GallStone	327
Goitre	544
Micro	210
MyrtleBlade	210
WithEye	346
Proctoscopes	446
ProfundaClamps	360
Prostatic,LobeHoldingForceps	360
Retractors	473
Protectors	120
<b>PROVIDENCE</b> ,HemostaticForceps	469
PterygiumKnives	469
Ptosis Knives	482
PunctureCannulas	273
<b>PUTTI</b> ,BoneRasps	339
PylorusSpreaders	339
<b>Q</b>	
<b>QUERVAIN</b> ,Elevators	282
<b>QUINBY</b> ,GumScissors	92
<b>QUIRE</b> ,ForeignBodyLevers	570
<b>R</b>	
Rachiotomes	31
RadialKeratotomyInstruments	487,501
<b>RAGNELL-DAVIS</b> ,Retractors	159
<b>RADOLF</b> ,ForcepsForTearingoutFingerNails	309
<b>RAMPLEY</b> ,SpongeHoldingForceps	148
<b>RAMUS</b> ,Retractors	185
<b>RANDALL</b> ,BiopsyCurettes	391
KidneyStoneForceps	354
<b>RANEY</b> ,ApplyingandRemovingForceps	508
Raspatories	188
RaspatoriesForMaxillofacialSurgery	602
Rasps <b>TC</b>	606
<b>RAY</b> ,Curettes	559
Razors	26
RazorBladeHoldersandBreakers	30
<b>RECAMIER</b> ,UterineCurettes	404
Rectal,AspirationCannulas	349
BiopsySpecimenForceps	348
Coolers	349
Snares	349
Speculas	344-345
<b>REICHERT</b> ,EpiglottisRetractors	631
<b>REINER</b> ,PlasterKnives	256
<b>RESANO</b> ,IntestinalClampForceps	336
Resection,Knives	28
Saws	310
Retractors,	150-179,190-209,296
ForMaxillofacialSurgery	181-187
<b>REVERDIN</b> ,AbdominalandIntestinal,Spatulas	180
Needles	249-250



## R

	Pages#
<b>REYNOLDS</b> , Scissors	52
Scissors, <b>SuperCut</b>	35-36
Rhinology Instruments	589-614
Rhinoplastic, Hooks	609
Knives	599-600
<b>RHOTON</b> , MicroSurgical Instruments	545
Rib, Contractors	420
Shears	412
Spreaders	413-419
<b>RICARD</b> , Abdominal	200
<b>RICHARDSON</b> , Retractors	173-174
<b>RICHARDSON-EASTMAN</b> , Retractors	173
<b>RICHNAU-HOLGREN</b> , Ear Speculas	566
<b>RICHTER</b> , Scissors	42
Vulval Retractors	200
<b>RICHTER-HEATH</b> , Clip Applying Forceps	255
<b>RIGBY</b> , Abdominal Retractors	201
<b>RITTER-HALLE</b> , Wash Cannulas	614
<b>ROBERTS</b> , Hemostatic Forceps	126
<b>ROCHESTER-CARMALT</b> , Hemostatic Forceps	122
<b>ROCHESTER-PEAN</b> , Hemostatic Forceps	121
<b>ROEDER</b> , Towel Forceps	143
Ligature Instruments	620
<b>ROGERS</b> , Hysterectomy Forceps	135
<b>ROGGE</b> , Sterilizing Forceps	632
<b>ROLLET</b> , Extirpation Chisels	471
Tear Sac Hooks	472
<b>ROSE</b> , Trachea Retractors	157
<b>ROSEN</b> , Micro Curettes	581
Micro Dissectors	581
Micro Hooks	579-580
Micro Knives	578
Micro Measuring Road	581
Micro Needles	579-580
<b>ROSEN-KONIG</b> , Mouth Gags	616
<b>ROSS</b> , Retractors	181
<b>ROUX</b> , Retractors	160
<b>RUBIN</b> , Septum Forceps	611
<b>RUBMAN-BORES</b> , Corneal Fixation Forceps	501
<b>RUDD</b> , Haemorrhoidal Ligators	350
<b>RUMEL</b> , Dissecting and Ligature Forceps	128
<b>RUMEL-BELMONT</b> , Tourniquets	456
<b>RUSKIN</b> , Bone Rongeur Forceps	303-304
<b>RUSKIN-LISTON</b> , Bone Cutting Forceps	308
<b>RUSSIAN</b> , Tissue Forceps	105
<b>RYDEL-SEIFFERT</b> , Tuning Forks	567
<b>RYDER</b> , Needle Holders TC	238

## S

<b>SAALFELD</b> , Comedone Extractors	328
<b>SACHS</b> , Elevators	518-519
Dissectors	518-519
<b>SAENGER</b> , Ovum Forceps	406
Safety Pins	632
<b>SALENIUS</b> , Meniscotomy Knives	291
<b>SAMIL</b> , Tumor Knives	548
<b>SANDERS-BROWN</b> , Awls	189
<b>SANTULLI</b> , Bulldog Clamps	426
<b>SANVENERO</b> , Scissors	55
<b>SAROT</b> , Hemostatic Forceps	127
Needle Holders	231
Needle Holders TC	238
<b>SATINSKY</b> , Hemostatic Forceps	422
Vascular Scissors	57
<b>SATINSKY-DE-BAKEY</b> , Tangential Occlusion Clamps	437
<b>SATO</b> , Corneal Knives	468
Knife Cannulas	482
<b>SATTERLEE</b> , Amputation Saws	310
<b>SATTLER</b> , Muscle Forceps	491
<b>SAUER</b> , Eye Speculas	461
<b>SAUERBRUCH</b> , Bone Rongeur Forceps	306
Retractors	168, 177
Rib Shears	412
Waste Forceps	632

	Pages#
<b>SAUERBRUCH-FREY</b> , Rib Shears	412
<b>SAUTER</b> , Air Injection Cannulas	182
<b>SAUTER</b> , Orbit Spatulas	473
Scalp Flap Forceps	138
Scalpel Handles	20-21
<b>SCHAEDEL</b> , Towel Forceps	142
<b>SCHAMBERG</b> , Comedone Extractors	328
<b>SCHUDE</b> , Bone Curettes	268
<b>SCHIE</b> , Goniotomy Knives	469
<b>SCHINMANN</b> , Tips	629
<b>SCHEPENS</b> , Lid Retractors	463
<b>SCHERBAK</b> , Vaginal Speculas	378
Schimmelbusch Inhalers	14
<b>SCHINDLER</b> , Hysterectomy Forceps	141
<b>SCHLESINGER</b> , Laminectomy Rongeurs	534
<b>SCHMEDEN</b> , Nasal Cutting Forceps	596
<b>SCHMID</b> , Spatulas	215
Vessel Irrigating Cannulas	215
<b>SCHMIDEN-DICK</b> , Ligature Needles	243
<b>SCHMIDEN-PAYR</b> , Ligature Conductors	258
<b>SCHMIDEN-TAYOR</b> , Dura Scissors	84
<b>SCHNIDER</b> , Periosteal Raspatories	275
<b>SCHNIDER-SAUERBRUCH</b> , Periosteal Raspatories	275
<b>SCHNIDT</b> , Hemostatic Forceps	125
<b>SCHOEMAKER-LOTH</b> , Wire Cutting Scissors	86
<b>SCHOEBORN</b> , Thyroid Gland Retractors	325
<b>SCHRECK</b> , Puncture Cannulas	462
<b>SCHROEDER</b> , Tenaculum Forceps	386
Uterine Curettes	399
<b>SCHUBERT</b> , Cervical Biopsy and Specimen Forceps	393
<b>SCHUHKNECHT</b> , Wire Cutting Scissors	87
Knives	578
<b>SCHUMACER</b> , Bone Levers	287
Cervical Biopsy and Specimen Forceps	394-395
Umbilical Scissors	62
Tips	629
<b>SCHWEIZ</b> , Discission Needle	496
Scissors,	34-94
Abdominal	50
Arteriotomy	60
Bandage	87-88
Cartilage	57
Cephalotomy	50
Clothing	90
Coronary	55
Crown	91
Dissecting	41, 43-49, 55, 60, 84
Dura	84
Enderterectomy	36
Enterotomy	61
Enucleation	52
Episiotomy	62
Eye	80-83
Fine Operating Scissors	51-54, 80
Fistula	50
Gum	92-94
Gynecological	40-41
Incision	42
Iridectomy	65-69
Iris	53
Iris <b>SuperCut</b>	35
Ligature	85-86
Lobectomy	61
Micro Dissecting	70-79
Nail	94
Nail Splitting	87
Nasal	37, 63
Nerve Dissecting	60
NeuroSurgical	84
Parametrium	62
Plaster	90
Skin	53
Sternum	412
Strabismus	83
<b>SuperCut</b>	34-37
Tenotomy	37, 82
Tissue	38-40, 42-44
Tonsil	60-61



## S

	Pages#		Pages#
Umbilical	62	<b>SIMPSON-SMITH</b> ,Suction Tubes	13
Uterine	34,49-50	<b>SIMS</b> ,RectalSpeculas,	344
Vascular	55-59	UterineCurettes	402
WireCutting	86-87	UterineScissors	49
ScleralHooks	472	UterineScissors <b>SuperCut</b>	35
Sclerotomes	469	UterineSounds	382
<b>SCOVILLE</b> ,NerveRetractors	524	VaginalSpeculas	370
NerveRootRetractors	522-523	<b>SIMS-MAIER</b> ,DressingForceps	146
<b>SCOVILLE-HAVERFIELD</b> ,Retractors	203	<b>SINGLEY-TUTTLE</b> ,GraspingForceps	106
Screw,Drivers	318	SinusForceps	145
NutWrenches	318	<b>SKENE</b> ,TenaculumForceps	386
<b>SCUDDER</b> ,IntestinalClampForceps	333	Skin,Curettes	328
<b>SEBILEAU</b> ,Elevators	283	Hooks	329
SecretionScoops	341	Scissors	53
<b>SEDILLOT</b> ,PeriostealRaspatories	274	SkullBreakers	31
<b>SEGOND</b> ,HysterectomyForceps	141	<b>SLUDER-BALLENGER</b> ,Tonsillectome	625
MyomaKnives	390	<b>SMELLIE</b> ,Perforators	407
<b>SEGOND-LANDAU</b> ,HysterectomyForceps	141	<b>SMILLIE</b> ,MeniscotomyKnives	291
<b>SEIFFERT</b> ,Tips	629	MeniscusRetractors	290
<b>SELDIN</b> ,PeriostealRaspatories	275	<b>SMITH(USAPATTERN)</b> ,BandageScissors	89
<b>SELLHEIM</b> ,ElevatingSpoons	407	<b>SMITH</b> ,WireCuttingScissors	87
<b>SELLORS</b> ,RibContractors	420	<b>SMITH-BUIE</b> ,AnalRetractors	345
<b>SEMB</b> ,BoneCuttingForceps	308	<b>SMITH-FISHER</b> ,IrisSpatulas	485
BoneHoldingForceps	295	<b>SMITH-PETERSON</b> ,BoneChisels	260
BoneRongeurForceps	305	BoneGouges	260
BronchusClamps	422	BoneRongeurForceps	304
PeriostealRaspatories	278	<b>SMITHWICK</b> ,NerveRetractors	526-527
<b>SEMKEN</b> ,DressingForceps	96	<b>SNELLEN</b> ,EarLoops	585
TissueForceps	103	EntropiumForceps	491
<b>SEMM</b> ,AbdominalRetractors	207	LensScoops	475
VaginalSpeculas	369	<b>SOERENSEN-HEIN</b> ,Retractors	186
<b>SENN-GREEN</b> ,Retractors	159	<b>SOMER</b> ,UterineElevatingForceps	389
<b>SENN-MILLER</b> ,Retractors	159	SpatulasDissectors	553
SensibilityInstruments	1	Speculas,Eye	459-462
Septum,Chisels	604	ForLaserSurgery	368
CompressionForceps	611	Lateral	368
Elevators	601-602	Rectal	344-345
Forceps	594-595,597	Vaginal	366-378
Knives	599-600	<b>SPENCER</b> ,LigatureScissors	85
SettingForceps	424	<b>SPENCER-FINE</b> ,LigatureScissors	85
<b>SEUTIN</b> ,PlasterandBandageScissors	90	<b>SPENCER-WELLS</b> ,HemostaticForceps	134
<b>SEYFFERT</b> ,VaginalSpeculas	369	SphenoidPunches	584
<b>SEWALL</b> ,Curettes	612	Sphincterosopes	346
<b>SEXTON</b> ,Knives	586	<b>SPINA-NASALIS</b> ,Retractors	185
<b>SHAPLEIGH</b> ,Curettes	585	<b>SPINAL</b> ,BoneCurettes	272
<b>SHEA</b> ,MicroScissors	573	Retractors	290
Spoons	582	SplinterForceps	107-108
Shears,Plaster	90	SpongeHoldingForceps	148
Rib	412	SpoonsForEar	585
<b>SHEETS</b> ,IrrigatingVectisCannulas	480	<b>SPRAGUE</b> ,EarOperationSet	587
<b>SHPEPARD</b> ,Forceps	499	<b>SPRATT</b> ,BoneCurettes	267
<b>SHORTBENT</b> ,LigatureScissors	85	<b>SPURLING</b> ,LaminectomyRongeurs	530-531
<b>SICHEL</b> ,IrisKnives	468	<b>ST.CLAIR-THOMPSON</b> ,AdenoidCurettes	613
<b>SICKLE</b> ,Dissectors	549,553	<b>ST.MARKS</b> ,Retractors	171
Elevators	549	<b>ST.MARTIN</b> ,SutureForceps	504
Hooks	550-551	<b>STACK</b> ,Probes	210
Knives	549	<b>STANDARD-NELSON</b> ,Trocars	6
Needles	549	<b>STAUDE-MOORE</b> ,TenaculumForceps	385
Raspatories	549	<b>STEINMANN</b> ,TendonGraspingForceps	323
<b>SIEBENMANN</b> ,WashCannulas	614	TendonPassingForceps	324
<b>SIEBOLD</b> UterineScissors, <b>SuperCut</b>	35	<b>STELLBRINK</b> ,BoneRongeurForceps	299
<b>SIEGLE</b> ,EarSpeculas	566	Sterilizing,Forceps	632
<b>SILVER</b> ,Chisels	604	Instruments	632
<b>SIMCOE</b> ,CapsulePolishingCannulas	480	<b>STERNBERG</b> ,TongueDepressors	617
CortexAspiratingCannulas	480	Sternum,Chisels	412
IrrigatingVectisCannulas	480	Scissors	412
Irrigating/AspirationCannulas	479	Stethoscopes	1
<b>SIMON</b> ,BoneCurettes	269	<b>STEVENS</b> ,IrisForceps	495
FistulaHooks	390	LensHooks	473
FistulaKnives	26	MicroNeedleHolders	225
Retractors	175	TenotomyScissors	82
UterineCurettes	399	TenotomyScissors, <b>SuperCut</b>	37
<b>SIMPSON</b> ,LachrymalDilators	484	<b>STEVENSON</b> ,EyeSpeculas	462
ObstetricalForceps	409	<b>STIEGLITZ</b> ,SplinterForceps	108
UterineSounds	382	<b>STILLE</b> ,BoneChisels	263
<b>SIMPSON-BRAUN</b> ,ObstetricalForceps	409	BoneGouges	263
<b>SIMPSON-LUIKART</b> ,ObstetricalForceps	409	BoneOsteotomes	263

## S

	Pages#
BoneRongeurForceps	306
DoubleEndedInstruments	485
DressingForceps	95
KidneyPedicleClampForceps	353
PlasterofParisShears	90
<b>STILLE-BARRYA</b> ,TissueForceps	106
<b>STILLE-LISTON</b> ,BoneCuttingForceps	308
<b>STILLE-LUER</b> ,BoneRongeurForceps	305
<b>STILLE-RUSKIN</b> ,BoneRongeurForceps	306
<b>STOCK</b> ,IrisSpatulas	473
<b>STOCKMANN</b> ,PenisClamps	365
StomachandIntestinalInstruments	330-343
StomachClampForceps	340-341,343
<b>STONE</b> ,TissueForceps	10
Strabismus,Forceps	489-490
Hooks	473
Scissors	83
<b>STRANDELL-STILLE</b> ,Retractors	158
<b>STRATTE</b> ,NeedleHolders <b>TC</b>	239
<b>STRAUSS</b> ,PenisClamps	365
<b>STRULLY</b> ,NeurosurgicalScissors	64,84
<b>STRUMPEL</b> ,EarPolypusForceps	571
<b>STRUYCKEN</b> ,NasalCuttingForceps	596
SuctionandIrrigatingCannulas	456
SuctionTubes	9-13,568
<b>SUCKER</b> ,EyeSpatulas	473
<b>SULLIVAN</b> ,GumScissors	93
SuperCutScissors	34-37
Suture,Forceps	488-489
Instruments	216-255
PusherandKnotTiers	544
<b>SWEDISH-PATTERN</b> ,BoneCurettes	267
<b>SWISS-MODEL</b> ,ForeignBodyNeedles	469
IrisForceps	492
VaginalSpeculas	366

## T

<b>TABB</b> ,MicroForceps	573
MicroKnives	578
<b>TAKAHASHI</b> ,SeptumForceps	595
TamponForceps	593
TangentialOcclusionClamps	437
<b>TARNIER</b> ,Basiotribes	408
ObstetricalForceps	411
<b>TAYLOR</b> ,DressingForceps	97
NerveRootRetractors	523
PercussionHammers	2
SpinalRetractors	290
TissueForceps	103
<b>TEALE</b> ,TenaculumForceps	388
TenaculumForceps	385-388
Tendon,GraspingForceps	122,323
PassingForceps	322
SeizingInstruments	322-324
SheathHooks	158
Strippers	322
TunnellInstruments	322-324
<b>TERRIER</b> ,HemostaticForceps	116
<b>TERSON</b> ,CapsularForceps	497-498
<b>TESSIER</b> ,Osteotomes	188
Retractors	186
<b>THOMAS</b> ,UterineCurettes	400
<b>THOMPSON-WALKER</b> ,BladderRetractors	362
<b>THOMS-ALLIS</b> ,IntestinalTissueForceps	330
<b>THOMS-GAYLOR</b> ,CervicalBiopsyand SpecimenForceps	393
ThoracicRetractors	417
<b>THUDICHUM</b> ,NasalSpeculas	592
<b>THUDICHUM(GOLDSMITH)</b> Nasal Speculas	592
ThyroidGlandRetractors	325
<b>TIECK</b> ,NasalSpeculas	590
<b>TILLY</b> ,EarPolypusForceps	570
<b>TISCHER</b> ,CervicalBiopsyandSpecimen Forceps	393,398
<b>TISCHER-MORGAN</b> ,CervicalBiopsyand SpecimenForceps	396
Tissue,Forceps	100-106,502
Lifters	610

Picks	544,610
<b>TOBOLD</b> ,TongueDepressors	618
<b>TOENNIS</b> ,DissectingandLigatureForceps	131
DissectingScissors	60
DissectingScissors, <b>TC</b>	60
Dissectors	517
Knives	525
NeedleHolders	233
NeedleHolders <b>TC</b>	241
NerveRetractors	525
<b>TOENNIS-ADSON</b> ,DissectingScissors	60
<b>TOENNIS-ADSON-FINE</b> ,ArteriotomyScissors	60
<b>TOHOKU</b> ,TowelForceps	142
Tongue,Depressors	616-619
Forceps	619
Tonsil,Elevators	622
Forceps	136,623
Hemostatic	136,623
Instruments	621-625
Knives	621
Needles	620
Punches	625
Retractors	622
Scissors	61-62
SeizingForceps	622
Snares	624
Tonsillectomes	625
<b>TOOK</b> ,CornealKinves	468
Tourniquets	456
TowelForceps	142-143
<b>TOWNLEY</b> ,Calipers	5
<b>TOWNSEND</b> ,BiopsyCurettes	342
<b>TOYNBEE</b> ,EarSpeculas	564
Trachea,Dilators	325
Retractors	325
Trocars	325
Tubes	326
TracheotomyInstruments	325-326
TrachomaForceps	500
TractionHandleforObstetricalForceps	410
<b>TRAUBE</b> ,PercussionHammers	3
<b>TRAVERS</b> ,Retractors	195
<b>TRELAT</b> ,TonsilNeedles	620
<b>TRELET</b> ,VaginalSpeculas	367
<b>TREVES</b> ,TissueForceps	101
TrigeminalScissors	64
Trocars	6-8
<b>TROELTSCH</b> ,EarandNasalForceps	111
EarSpeculas	564
<b>TROELTSCH-WILDE</b> ,EarandNasalForceps	111,569
TamponForceps	593
<b>TROEMNER</b> ,PercussionHammers	2
<b>TROUSSEAU</b> ,TracheaDilators	325
<b>TROUSSEAU-BABY</b> ,TracheaDilators	325
<b>TROUTMANN</b> ,IridectomyScissors	68
LensScoops	475
<b>TROUTMANN-BARRAQUER</b> ,IridectomyScissors	67
<b>TROUTMANN CASTROVIEJO</b> ,IridectomyScissors	69
<b>TROUTMANN-CHRIS</b> ,RazorBladeBreakers	30
<b>TROUTMANN-COLIBRI</b> ,IrisForceps	497
TrumpertGuideNeedles	405
<b>TUBBS</b> ,AorticDilators	457
TubingForceps	144
<b>TUEBINGEN</b> ,IrisHooks	470
Retractors	176,192
SutureForceps	488
<b>TUFFIER</b> ,AbdominalandIntestinalSpatulas	180
HemostaticForceps	115
Retractors	175
RibSpreaders	414
TumorGraspingForceps	112-113,535
Knives	548
TuningForks	567-568
TwinClampForceps	341,343
<b>TYDING</b> ,TonsilSnares	624

## U

## U

	Pages#
<b>UCKERMANN</b> , Cotton Applicators	212
Trachea Trocars	325
<b>UFFENORDE</b> , Bone Curettes	268
<b>ULRICH</b> , Cotton Swab Forceps	145
Fistula Knives	26
Vaginal Speculas	375
Umbilical Cord Clamps	408
Scissors	62
<b>UNIVERSAL</b> , Bandage Scissors	87
Cotton Applicators	212
Handles	628
Sterilizing Forceps	632
Trocars	6
Wire Cutting Scissors	88
Wire Cutting Scissors <b>TC</b>	64
<b>UNNA</b> , Comedone Extractors	328
Urology Instruments	365
<b>USA</b> , Bone Chisels	258
Bone Gouges	258
Bone Osteotomes	258
Dressing Forceps	95
Perineum Scissors	62
Plaster Spreaders	256
Tissue Forceps	101
Uterine, Curettes	399-404
Depressors	382
Dilators	379-381
Elevating Forceps	389
Hemostatic Forceps	406
Polypus	388
Scissors	48-49
Scissors <b>SuperCut</b>	35

## V

Vaginal, Forceps	138-139
Sounds	382
Retractors	374, 378
Speculas	366-378
Speculas For Laser Surgery	368
<b>VALLEIX</b> , Uterine Sounds	362
<b>VANBUREN</b> , Bone Holding Forceps	292
Dilating Bougies	363
<b>VANDOREN</b> , Cervical Biopsy and Specimen Forceps	393
<b>VANNAS</b> , Iridectomy Scissors	66
Micro Scissors	70
<b>VANNASTUEBINGEN PATTERN</b> , Iridectomy Scissors	65
Varicose Vein Probe Set	214
Vascular, Dilators	458
Scissors	55-59
Retractors	157
Scissors	74
Strippers	214
Vein Scissors	74
<b>VERBRUGGE</b> , Bone Holding Forceps	295
<b>VERBRUGGE-MUELLER</b> , Bone Levers	288
<b>VERINER</b> , Calipers	5
Vessel, Irrigating Cannulas	215
Dilators	544
Probes	544
<b>VIDAL</b> , Lupus Scrapers	329
<b>VIENNA</b> , Nasa Specula	591
<b>VIRCHOW</b> , Autopsy Knives	29
<b>VOLKMANN</b> , Bone Curettes	265, 269
Retractors	156, 162-163
Vulval Retractors	200

## W

<b>WACHENFELDT</b> , Clip Applying Forceps	255
<b>WAGNER</b> , Bone Levers	286
Foreign Body Hooks	586
Periosteal Raspatories	281
Scissors	51
Scissors, <b>SuperCut</b>	35
<b>WALSHAM</b> , Septum Straightening Forceps	611
<b>WALLICH</b> , Abortion Scoops	406

	Pages#
<b>WALTER</b> , Chisels	604
<b>WALTER-CARMALT</b> , Splinter Forceps	108
<b>WALTON</b> , Foreign Body Chisels	47
Scissors	53
<b>WANGENSTEEN</b> , Dressing Forceps	99
Needle Holders	231
Needle Holders <b>TC</b>	239
<b>WARTENBURG</b> , Sensibility Instruments	1
<b>WASSMUND</b> , Retractors	166
Waste Forceps	632
Watchmaker's Forceps	106, 504
<b>WATSON-CHEYNE</b> , Elevators	283
Probes	210
<b>WATSON-WILLIAMS</b> , Septum Forceps	595
<b>WAUGH</b> , Dressing Forceps	97
Tissue Forceps	104
<b>WEBER</b> , Aortic Clamps	436
Canaliculus Knives	467
Lens Scoops	475
Sensibility Instruments	1
<b>WEBSTER</b> , Needle Holders	229
Needle Holders <b>TC</b>	235
<b>WECKER</b> , Iridectomy Scissors	65
Iris Spatulas	473
<b>WEISS</b> , Eye Speculas	459
<b>WEIL-BLAKESLEY</b> , Laminectomy Rongeurs	536
Nasal Cutting Forceps	596
<b>WEITLANER</b> , Retractors	192, 194
<b>WEITLANER-BABY</b> , Retractors	193
<b>WEITLANER-WULLSTEIN</b> , Retractors	192
<b>WELLS</b> , Enucleation Scoops	476
<b>WERTHEIM</b> , Clamp Forceps	138, 140
Gynecological Scissors	49
Peritoneal Clamp Forceps	138-139
<b>WERTHEIM-CULLEN</b> , Clamp Forceps	138
<b>WESSELEY-GRIESHABER</b> , Keratomes	466
<b>WEST</b> , Lachrymal Sac Chisels	483
Lachrymal Sac Gouges	483
Septum Chisels	605
Septum Gouges	605
Tampon Forceps	593
<b>WESTCOTT</b> , Iridectomy Scissors	68
<b>WESTMACOTT</b> , Tampon Forceps	593
<b>WHEELER</b> , Cataract Knives	464
Cyclodialysis Spatulas	485
<b>WHITE</b> , Tonsil Forceps	623
<b>WHITEHEAD</b> , Mouth Gags	617
<b>WICKSTROEM</b> , Dissecting and Ligature Forceps	133
<b>WIEN</b> , Ligature Catchers	254
Nasal Speculas	591
<b>WIENER</b> , Iris Hooks	471
Keratomes	466
<b>WILDE</b> , Ear Forceps	111
<b>WILDER</b> , Lachrymal Dilators	483
Tongue Depressors	619
<b>WILLET-MARTELL</b> , Scalp Flap Forceps	407
<b>WILLIAMS</b> , Eye Speculas	461
Intestinal Tissue Forceps	331
<b>WILLIGER</b> , Bone Curettes	268, 271
Elevators	282
Mallets	320
Periosteal Raspatories	275-276
<b>WILMER</b> , Eye Scissors	83
<b>WINTER</b> , Ovum Forceps	83
Wire, Closure Forceps	576
Cutting Pliers	315-316
Cutting Pliers <b>TC</b>	316
Cutting Scissors	87
Cutting Scissors <b>TC</b>	64
Guides	319
Seizing Forceps	313-314
Seizing Forceps <b>TC</b>	313
Strainers For Extension Bows	318
Twisting Forceps	319
<b>WITTNER</b> , Cervical Biopsy and Specimen Forceps	396
<b>WOLFF</b> , Lupus Curettes	329
Plaster Cast Forceps	257
<b>WOODRUFF</b> , Ligature Needles	505

## W

<b>WOODSON</b> Dissectors	518
<b>WORTH</b> Advancement Forceps	490
Wound and Nerve Hooks	150-151
Trachea Retractors	152-153,155-156
Vein Retractors	157
<b>WRIGLEY</b> Obstetrical Forceps	409
<b>WULLSTEIN</b> Micro Knives	578
<b>WURZBURG</b> Tongue Drepessors	616

## Y

<b>YANKAUER</b> Elevators	282
Inhalers	14
Suction Tubes	11
Tonsil Elevators	622
<b>YASARGIL</b> Brain Suction Tube	9.13
Dissectors	542
Ligature Guides	543
Micro Forceps	113-114
Micro Needle Holders	220
Micro Raspatories	542
Micro Vessel Knives	541
Micro Scissors	70-71
Micro Scoops	542
Tumor Grasping Forceps	112-113
<b>YASAR-NICOLA</b> Pituitary Instruments	539
<b>YEOMAN</b> Biopsy Specimen Forceps	348
Rectal Biopsy Specimen	348
<b>YOUNG</b> Prostatic Retractors	360
Suture Instruments	249
Tongue Forceps	619

## Z

<b>ZAUFAL-JANSEN</b> Bone Rongeur Forceps	300-303
<b>ZAUFEL</b> Foreign Body Instruments	586
<b>ZENKER</b> Dissecting and Ligature Forceps	128
Retractors	179
<b>ZIEGLER</b> Capsulotomy Knives	467-468
Cilia Forceps	110
Discission Knives	468
<b>ZIELKE</b> Bone Gouges	263
<b>ZOLLINER</b> Ear Speculas	565
Micro Instruments	583
<b>ZWEIFEL</b> Needle Holders TC	241
Pressure Clamps	137



## 10

Cat #	Pg #
10-01000-17	1
10-01004-19	1
10-01008-09	1
10-01012-18	1
10-01016-15	1
10-01020-00	1
10-01020-01	1
10-01024-00	1
10-01024-01	1
10-01028-18	2
10-01032-18	2
10-01036-24	2
10-01040-16	2
10-01040-18	2
10-01040-20	2
10-01044-20	2
10-01046-20	2
10-01050-20	2
10-01054-16	3
10-01058-21	3
10-01062-22	3
10-01066-22	3
10-01066-25	3
10-01068-23	3
10-01070-33	3
10-01074-26	3
10-01078-00	4
10-01082-00	4
10-01086-00	4
10-01092-00	4
10-01096-01	5
10-01096-02	5
10-01100-00	5
10-01104-14	5
10-01108-10	5

## 11

Cat #	Pg #
11-01112-30	6
11-01112-35	6
11-01112-40	6
11-01112-45	6
11-01112-50	6
11-01112-55	6
11-01112-60	6
11-01116-30	6
11-01116-35	6
11-01116-40	6
11-01116-45	6
11-01116-50	6
11-01116-55	6
11-01116-60	6
11-01120-30	6
11-01120-35	6
11-01120-40	6
11-01120-45	6
11-01120-50	6
11-01120-55	6
11-01120-60	6
11-01124-03	6
11-01124-04	6
11-01128-03	6
11-01128-04	6
11-01132-16	7
11-01136-19	7
11-01140-16	7
11-01144-24	7
11-01148-07	8
11-01148-09	8
11-01148-10	8
11-01148-12	8
11-01152-40	8
11-01152-46	8
11-01152-55	8
11-01152-65	8
11-01156-15	8

## 12

Cat #	Pg #
12-01180-06	9
12-01180-07	9
12-01180-08	9
12-01180-09	9
12-01180-10	9
12-01180-11	9
12-01180-12	9
12-01180-15	9
12-01184-06	9
12-01184-07	9
12-01184-08	9
12-01184-09	9
12-01184-10	9
12-01184-11	9
12-01184-12	9
12-01184-15	9
12-01192-13	9
12-01192-15	9
12-01192-18	9
12-01192-22	9
12-01193-13	9
12-01193-15	9
12-01193-18	9
12-01193-22	9
12-01194-13	9
12-01194-15	9
12-01194-18	9
12-01194-22	9
12-01195-13	9
12-01195-15	9
12-01195-18	9
12-01195-22	9
12-01196-18	9
12-01198-17	9
12-01198-25	9
12-01198-35	9
12-01202-20	10
12-01202-25	10
12-01202-30	10
12-01206-15	10
12-01206-20	10
12-01206-25	10
12-01206-30	10
12-01210-04	10
12-01214-02	10
12-01214-03	10
12-01214-04	10
12-01214-05	10
12-01218-27	11
12-01219-27	11
12-01220-01	11
12-01220-11	11
12-01220-12	11
12-01220-13	11
12-01220-16	11
12-01220-20	11
12-01224-01	11
12-01224-02	11
12-01228-23	11
12-01232-30	12
12-01236-17	12
12-01240-20	12
12-01240-22	12
12-01244-22	12
12-01248-34	13
12-01252-01	13

## 13

Cat #	Pg #
12-01252-02	13
12-01252-03	13
12-01252-04	13
12-01252-05	13
12-01252-06	13
12-01252-60	13
12-01256-01	13
12-01256-02	13
12-01256-03	13
12-01262-30	13
12-01266-00	13
12-01272-01	14
12-01272-02	14
12-01276-01	14
12-01276-02	14
12-01280-15	14
12-01280-20	14
12-01280-25	14
12-01284-01	14
12-01284-02	14
12-01288-01	14
12-01288-02	14
12-01288-03	14
12-01292-00	15
12-01292-01	15
12-01292-02	15
12-01292-03	15
12-01292-04	15
12-01292-05	15
12-01292-06	15
12-01292-07	15
12-01292-08	15
12-01296-01	15
12-01296-02	15
12-01296-03	15
12-01296-04	15
12-01296-05	15
12-01296-06	15
12-01296-07	15
12-01296-08	15
12-01300-01	15
12-01300-02	15
12-01300-03	15
12-01304-01	15
12-01304-02	15
12-01304-03	15
12-01308-01	15
12-01308-02	15
12-01308-03	15
12-01312-18	15
12-01312-20	15
12-01316-30	16
12-01316-40	16
12-01316-10	16
12-01316-11	16
12-01316-12	16
12-01316-13	16
12-01316-14	16
12-01320-30	17
12-01320-40	17
12-01320-11	17
12-01320-12	17
12-01320-13	17
12-01320-14	17
12-01324-30	18
12-01324-40	18
12-01324-11	18
12-01324-12	18
12-01324-13	18
12-01324-14	18
12-01328-20	19
12-01328-10	19
12-01328-11	19
12-01332-00	19
12-01336-00	19
12-01340-00	19
12-01344-00	19

## 14

Cat #	Pg #
13-01348-03	20
13-01352-03	20
13-01356-04	20
13-01360-04	20
13-01364-07	20
13-01368-17	20
13-01372-08	20
13-01376-09	20
13-01380-34	20
13-01384-13	21
13-01388-14	21
13-01392-03	21
13-01396-04	21
13-01400-05	21
13-01404-15	21
13-01408-01	21
13-01408-03	21
13-01412-01	22
13-01412-02	22
13-01412-03	22
13-01412-04	22
13-01412-05	22
13-01412-06	22
13-01412-07	22
13-01412-08	22
13-01412-09	22
13-01412-10	22
13-01416-01	23
13-01416-02	23
13-01416-03	23
13-01416-04	23
13-01416-05	23
13-01416-06	23
13-01416-07	23
13-01416-08	23
13-01416-09	23
13-01416-10	23
13-01416-11	23
13-01420-01	24
13-01420-02	24
13-01420-03	24
13-01420-04	24
13-01420-05	24
13-01420-06	24
13-01420-07	24
13-01420-08	24
13-01420-09	24
13-01420-15	24
13-01420-16	24
13-01424-01	25
13-01424-02	25
13-01424-03	25
13-01424-04	25
13-01428-01	25
13-01428-02	25
13-01428-03	25
13-01428-04	25
13-01428-05	25
13-01428-06	25
13-01428-07	25
13-01428-08	25
13-01428-09	25
13-01428-10	25
13-01428-11	25
13-01428-12	25
13-01432-01	26
13-01432-02	26
13-01432-03	26
13-01432-04	26
13-01436-01	26
13-01436-02	26
13-01436-03	26
13-01440-01	26
13-01440-02	26
13-01440-03	26
13-01440-04	26
13-01444-01	26

Cat #	Pg #
13-01444-02	26
13-01448-13	27
13-01448-16	27
13-01448-19	27
13-01448-22	27
13-01452-17	27
13-01452-20	27
13-01456-16	27
13-01456-19	27
13-01456-22	27
13-01460-12	27
13-01460-12	27
13-01460-17	28
13-01464-11	28
13-01468-11	27
13-01472-01	28
13-01472-02	28
13-01476-16	28
13-01476-20	28
13-01476-24	28
13-01480-11	28
13-01480-12	28
13-01480-17	28
13-01484-11	28
13-01488-08	28
13-01492-09	29
13-01496-19	29
13-01500-01	29
13-01504-01	29
13-01508-09	30
13-01509-09	30
13-01512-11	30
13-01516-13	30
13-01520-18	30
13-01524-14	31
13-01528-22	31
13-01532-13	31
13-01536-28	31
13-01537-28	31
13-01540-06	31
13-01544-07	31
13-01548-01	31
13-01552-13	32
13-01556-13	32
13-01560-24	32
13-01564-06	32
13-01568-01	32
13-01568-02	32
13-01568-03	32
13-01568-04	32
13-01568-05	32
13-01568-06	32
13-01572-00	33
13-01576-00	33

Cat #	Pg #
14-01605-20	34
14-01605-23	34
14-01608-20	35
14-01608-23	35
14-01609-20	35
14-01609-23	35
14-01613-24	35
14-01617-15	35
14-01617-18	35
14-01620-15	35
14-01621-15	35
14-01624-11	35
14-01625-11	35
14-01628-11	35
14-01629-11	35
14-01632-12	35
14-01633-12	35
14-01636-12	35
14-01637-12	35
14-01641-11	36
14-01645-14	36
14-01649-13	36
14-01653-19	36
14-01655-19	36
14-01657-19	36
14-01661-17	36
14-01665-14	37
14-01665-18	37
14-01665-20	37
14-01669-14	37
14-01669-22	37
14-01672-11	37
14-01673-11	37
14-01677-18	37
14-01681-13	37
14-01685-13	37
14-01689-16	37
14-01692-10	38
14-01692-11	38
14-01692-13	38
14-01692-14	38
14-01692-15	38
14-01692-16	38
14-01692-18	38
14-01692-20	38
14-01694-10	38
14-01694-11	38
14-01694-13	38
14-01694-14	38
14-01694-15	38
14-01694-16	38
14-01694-18	38
14-01694-20	38
14-01696-10	38
14-01696-11	38
14-01696-13	38
14-01696-14	38
14-01696-15	38
14-01696-16	38
14-01696-18	38
14-01696-20	38
14-01700-14	38
14-01702-14	38
14-0170	



## 14

Cat #	Pg #	Cat #	Pg #	Cat #	Pg #	Cat #	Pg #	Cat #	Pg #	Cat #	Pg #
14-01709-16	39	14-01810-14	45	14-01865-18	48	14-01959-11	53	14-02103-15	60	14-02317-10	69
14-01709-18	39	14-01812-14	45	14-01865-20	48	14-01961-09	53	14-02107-18	60	14-02321-11	69
14-01709-20	39	14-01814-14	45	14-01865-23	48	14-01961-10	53	14-02111-17	60	14-02323-11	69
14-01711-10	39	14-01818-14	45	14-01865-25	48	14-01961-11	53	14-02115-17	60	14-02327-10	69
14-01711-11	39	14-01820-14	45	14-01865-28	48	14-01964-09	53	14-02118-18	60	14-02329-10	69
14-01711-13	39	14-01822-14	45	14-01865-30	48	14-01964-10	53	14-02119-18	60	14-02332-14	69
14-01711-14	39	14-01825-14	46	14-01867-18	48	14-01964-11	53	14-02123-17	60	14-02332-18	69
14-01711-15	39	14-01827-14	46	14-01867-20	48	14-01965-09	53	14-02125-17	60	14-02333-14	69
14-01711-16	39	14-01829-14	46	14-01867-23	48	14-01965-10	53	14-02129-19	61	14-02333-18	69
14-01711-18	39	14-01831-14	46	14-01867-25	48	14-01965-11	53	14-02133-30	61	14-02336-12	70
14-01711-20	39	14-01833-14	46	14-01867-28	48	14-01968-10	53	14-02137-27	61	14-02336-16	70
14-01715-14	39	14-01835-14	46	14-01867-30	48	14-01971-09	53	14-02142-21	61	14-02336-18	70
14-01717-14	39	14-01838-18	47	14-01869-18	48	14-01975-10	53	14-02146-21	61	14-02337-12	70
14-01719-14	39	14-01838-20	47	14-01869-20	48	14-01978-14	54	14-02150-21	61	14-02337-16	70
14-01722-13	40	14-01838-23	47	14-01869-23	48	14-01979-14	54	14-02153-13	62	14-02337-18	70
14-01722-14	40	14-01838-25	47	14-01869-25	48	14-01982-10	54	14-02153-16	62	14-02340-12	70
14-01724-13	40	14-01838-28	47	14-01869-28	48	14-01983-10	54	14-02157-16	62	14-02340-16	70
14-01724-14	40	14-01838-30	47	14-01869-30	48	14-01986-13	54	14-02160-10	62	14-02341-12	70
14-01727-13	40	14-01840-18	47	14-01870-20	49	14-01987-13	54	14-02163-14	62	14-02341-16	70
14-01727-14	40	14-01840-20	47	14-01870-23	49	14-01990-14	54	14-02165-22	62	14-02344-16	71
14-01729-13	40	14-01840-23	47	14-01872-20	49	14-01991-14	54	14-02169-23	62	14-02344-20	71
14-01729-14	40	14-01840-25	47	14-01872-23	49	14-01995-12	55	14-02171-23	62	14-02345-16	71
14-01732-14	40	14-01840-28	47	14-01874-20	49	14-01995-13	55	14-02175-18	63	14-02345-20	71
14-01733-14	40	14-01840-30	47	14-01874-23	49	14-01995-15	55	14-02177-19	63	14-02347-20	71
14-01736-15	40	14-01842-18	47	14-01877-20	49	14-01998-14	55	14-02181-18	63	14-02350-20	71
14-01737-15	40	14-01842-20	47	14-01877-23	49	14-02002-11	55	14-02185-13	63	14-02351-20	71
14-01740-16	41	14-01842-23	47	14-01879-20	49	14-02005-19	55	14-02189-13	63	14-02354-22	72
14-01741-16	41	14-01842-25	47	14-01879-23	49	14-02009-15	55	14-02191-13	63	14-02354-24	72
14-01744-16	41	14-01842-28	47	14-01881-20	49	14-02013-15	55	14-02195-16	63	14-02355-22	72
14-01745-16	41	14-01842-30	47	14-01881-23	49	14-02017-15	55	14-02199-19	63	14-02355-24	72
14-01748-16	41	14-01844-18	47	14-01883-20	49	14-02021-19	56	14-02202-22	64	14-02357-22	72
14-01749-16	41	14-01844-20	47	14-01883-23	49	14-02023-19	56	14-02203-22	64	14-02360-22	72
14-01752-16	41	14-01844-23	47	14-01887-14	49	14-02025-19	56	14-02207-22	64	14-02361-22	72
14-01753-16	41	14-01844-25	47	14-01887-19	49	14-02027-19	56	14-02211-15	64	14-02364-18	73
14-01756-13	42	14-01844-28	47	14-01887-22	49	14-02031-19	56	14-02215-12	64	14-02365-18	73
14-01756-14	42	14-01844-30	47	14-01892-27	50	14-02033-19	56	14-02218-13	64	14-02367-18	73
14-01760-15	42	14-01848-18	47	14-01893-27	50	14-02035-19	56	14-02219-13	64	14-02370-19	73
14-01763-14	42	14-01848-20	47	14-01896-16	50	14-02039-20	57	14-02222-01	65	14-02371-19	73
14-01767-14	42	14-01848-23	47	14-01896-18	50	14-02042-19	57	14-02222-02	65	14-02373-19	73
14-01771-18	42	14-01848-25	47	14-01897-16	50	14-02045-19	57	14-02222-03	65	14-02376-19	73
14-01775-14	42	14-01848-28	47	14-01897-18	50	14-02049-24	57	14-02225-12	65	14-02377-19	73
14-01778-14	43	14-01848-30	47	14-01900-16	50	14-02053-23	57	14-02229-01	65	14-02384-12	74
14-01778-15	43	14-01850-18	47	14-01900-18	50	14-02057-16	58	14-02229-02	65	14-02385-12	74
14-01778-17	43	14-01850-20	47	14-01901-16	50	14-02057-23	58	14-02233-05	65	14-02392-12	74
14-01778-19	43	14-01850-23	47	14-01901-18	50	14-02057-28	58	14-02236-09	65	14-02393-12	74
14-01778-23	43	14-01850-25	47	14-01904-12	51	14-02059-16	58	14-02238-09	65	14-02395-12	74
14-01779-14	43	14-01850-28	47	14-01906-12	51	14-02059-23	58	14-02240-09	65	14-02400-13	74
14-01779-15	43	14-01850-30	47	14-01908-12	51	14-02059-28	58	14-02243-09	65	14-02404-16	75
14-01779-17	43	14-01852-18	47	14-01911-12	51	14-02061-16	58	14-02245-09	65	14-02405-16	75
14-01779-19	43	14-01852-20	47	14-01913-12	51	14-02061-23	58	14-02247-09	65	14-02408-16	75
14-01779-23	43	14-01852-23	47	14-01915-12	51	14-02061-28	58	14-02250-08	66	14-02409-16	75
14-01782-14	43	14-01852-25	47	14-01916-12	51	14-02063-13	58	14-02253-08	66	14-02412-16	75
14-01782-17	43	14-01852-28	47	14-01918-12	51	14-02063-16	58	14-02255-08	66	14-02413-16	75
14-01782-23	43	14-01852-30	47	14-01920-12	51	14-02063-19	58	14-02257-08	66	14-02416-18	76
14-01783-14	43	14-01855-18	48	14-01922-12	51	14-02065-13	58	14-02260-08	66	14-02417-18	76
14-01783-17	43	14-01855-20	48	14-01923-12	51	14-02065-16	58	14-02263-08	66	14-02421-18	76
14-01783-23	43	14-01855-23	48	14-01925-12	51	14-02065-19	58	14-02265-08	66	14-02424-16	77
14-01786-15	43	14-01855-25	48	14-01927-12	51	14-02067-13	58	14-02267-08	66	14-02425-16	77
14-01786-17	43	14-01855-28	48	14-01929-12	51	14-02067-16	58	14-02270-10	67	14-02428-16	77
14-01786-19	43	14-01855-30	48	14-01932-12	51	14-02067-19	58	14-02271-10	67	14-02429-16	77
14-01786-21	43	14-01857-18	48	14-01933-12	51	14-02069-13	58	14-02273-10	67	14-02432-16	77
14-01787-15	43	14-01857-20	48	14-01936-14	52	14-02069-16	58	14-02275-10	67	14-02433-16	77
14-01787-17	43	14-01857-23	48	14-01937-14	52	14-02069-19	58	14-02277-10	67	14-02436-18	78
14-01787-19	43	14-01857-25	48	14-01940-15	52	14-02071-13	58	14-02281-10	67	14-02437-18	78
14-01787-21	43	14-01857-30	48	14-01940-18	52	14-02071-16	58	14-02283-10	67	14-02441-18	78
14-01790-15	43	14-01859-18	48	14-01941-15	52	14-02071-19	58	14-02285-10	67	14-02444-23	78
14-01790-17	43	14-01859-20	48	14-01941-18	52	14-02075-19	58	14-02287-10	67	14-02448-14	79
14-01791-15	43	14-01859-23	48	14-01945-15	52	14-02079-18	59	14-02291-10	68	14-02449-14	79
14-01791-17	43	14-01859-25	48	14-01948-12	52	14-02081-18	59	14-02293-10	68	14-02451-14	79
14-01794-17	44	14-01859-28	48	14-01951-12	52	14-02083-18	59	14-02295-10	68	14-02454-11	80
14-01795-17	44	14-01859-30	48	14-01953-12	52	14-02085-18	59	14-02297-10	68	14-02455-11	80
14-01798-11	44	14-01861-18	48	14-01955-12	52	14-02087-18	59	14-02301-10	68	14-02458-11	80
14-01799-11	44	14-01861-20	48	14-01958-09	53	14-02091-18	59	14-02303-10	68	14-02459-11	80
14-01802-14	44	14-01861-23	48	14-01958-10	53	14-02093-18	59	14-02307-11	68	14-02462-12	80
14-01803-14	44	14-01861-25	48	14-01958-11	53	14-02095-18	59	14-02309-11	68	14-02463-12	80
14-01806-14	44	14-01861-28	48	14-01959-09	53	14-02097-18	59	14-02311-11	68	14-02466-10	80
14-01807-14	44	14-01861-30	48	14-01959-10	53	14-02099-18	59	14-02315-10	69	14-02467-10	80



**14**

Cat #	Pg #	Cat #	Pg #	Cat #	Pg #	Cat #	Pg #	Cat #	Pg #	Cat #	Pg #
14-02470-10	80	14-02595-11	86	14-02765-11	93	15-02814-13	95	15-02952-13	100	15-03054-25	103
14-02471-10	80	14-02599-12	86	14-02768-11	94	15-02814-14	95	15-02952-14	100	15-03058-12	103
14-02474-10	80	14-02603-12	86	14-02769-11	94	15-02814-15	95	15-02952-15	100	15-03058-13	103
14-02475-10	80	14-02607-01	87	14-02772-11	94	15-02818-13	95	15-02952-16	100	15-03062-12	103
14-02478-11	80	14-02607-02	87	14-02773-11	94	15-02818-14	95	15-02952-18	100	15-03062-15	103
14-02479-11	80	14-02607-03	87	14-02777-11	94	15-02818-15	95	15-02952-20	100	15-03066-15	103
14-02482-09	81	14-02607-04	87	14-02780-09	94	15-02822-12	96	15-02952-25	100	15-03066-20	103
14-02482-10	81	14-02609-01	87	14-02780-10	94	15-02822-15	96	15-02952-30	100	15-03066-25	103
14-02482-11	81	14-02609-02	87	14-02781-09	94	15-02826-12	96	15-02956-14	100	15-03070-15	103
14-02483-09	81	14-02609-03	87	14-02781-10	94	15-02826-15	96	15-02956-16	100	15-03070-20	103
14-02483-10	81	14-02609-04	87	14-02784-09	94	15-02830-12	96	15-02956-18	100	15-03070-25	103
14-02483-11	81	14-02611-01	87	14-02784-10	94	15-02830-15	96	15-02956-20	100	15-03074-17	103
14-02485-09	81	14-02611-02	87	14-02785-09	94	15-02834-12	96	15-02956-25	100	15-03075-17	103
14-02485-10	81	14-02611-03	87	14-02785-10	94	15-02834-15	96	15-02956-30	100	15-03078-17	103
14-02485-11	81	14-02611-04	87			15-02838-12	96	15-02960-13	100	15-03079-17	103
14-02487-09	81	14-02615-17	87			15-02838-15	96	15-02960-14	100	15-03082-15	104
14-02487-10	81	14-02618-12	87			15-02842-15	96	15-02960-16	100	15-03082-18	104
14-02487-11	81	14-02622-10	87			15-02844-15	96	15-02960-18	100	15-03082-20	104
14-02492-10	81	14-02626-13	87	15-02788-10	95	15-02848-12	96	15-02960-20	100	15-03086-20	104
14-02492-11	81	14-02626-15	87	15-02788-11	95	15-02848-15	96	15-02960-25	100	15-03087-20	104
14-02493-10	81	14-02629-09	88	15-02788-13	95	15-02849-12	96	15-02960-30	100	15-03092-18	104
14-02493-11	81	14-02629-10	88	15-02788-14	95	15-02849-15	96	15-02964-13	100	15-03093-18	104
14-02496-09	81	14-02629-11	88	15-02788-15	95	15-02852-12	96	15-02964-14	100	15-03096-18	104
14-02496-10	81	14-02629-14	88	15-02788-16	95	15-02852-15	96	15-02964-16	100	15-03097-18	104
14-02496-11	81	14-02629-18	88	15-02788-18	95	15-02856-17	97	15-02968-13	100	15-04000-18	104
14-02497-09	81	14-02629-20	88	15-02788-20	95	15-02857-17	97	15-02968-14	100	15-04000-21	104
14-02497-10	81	14-02631-18	88	15-02788-25	95	15-02862-17	97	15-02968-16	100	15-04000-25	104
14-02497-11	81	14-02633-18	88	15-02788-30	95	15-02863-17	97	15-02972-13	100	15-04001-18	104
14-02500-09	82	14-02633-21	88	15-02789-11	95	15-02867-17	97	15-02972-14	100	15-04001-21	104
14-02500-10	82	14-02637-16	88	15-02789-13	95	15-02870-15	97	15-02972-16	100	15-04001-25	104
14-02500-11	82	14-02637-19	88	15-02789-14	95	15-02870-18	97	15-02972-18	100	15-04004-14	105
14-02501-09	82	14-02641-20	88	15-02789-16	95	15-02870-20	97	15-02972-20	100	15-04008-20	105
14-02501-10	82	14-02641-22	88	15-02789-18	95	15-02874-18	97	15-02972-25	100	15-04012-14	105
14-02501-11	82	14-02645-23	88	15-02789-20	95	15-02874-20	97	15-02976-12	101	15-04012-16	105
14-02504-10	82	14-02649-23	88	15-02789-25	95	15-02878-20	97	15-02976-13	101	15-04012-20	105
14-02505-10	82	14-02653-17	89	15-02789-30	95	15-02882-18	97	15-02976-14	101	15-04016-15	105
14-02508-10	82	14-02657-18	89	15-02792-14	95	15-02886-18	97	15-02976-15	101	15-04016-20	105
14-02508-11	82	14-02661-24	89	15-02792-16	95	15-02887-18	97	15-02976-18	101	15-04016-25	105
14-02509-10	82	14-02663-24	89	15-02792-18	95	15-02890-15	98	15-02976-21	101	15-04020-23	105
14-02509-11	82	14-02667-24	89	15-02792-20	95	15-02890-18	98	15-02976-25	101	15-04022-18	105
14-02512-10	82	14-02671-18	89	15-02792-25	95	15-02894-13	98	15-02976-31	101	15-04023-18	105
14-02512-11	82	14-02671-20	89	15-02796-11	95	15-02895-13	98	15-02980-12	101	15-04026-14	105
14-02513-10	82	14-02671-23	89	15-02796-13	95	15-02898-12	98	15-02980-13	101	15-04026-20	105
14-02513-11	82	14-02674-14	89	15-02796-14	95	15-02898-15	98	15-02980-14	101	15-04028-14	105
14-02516-08	82	14-02675-14	89	15-02796-16	95	15-02898-18	98	15-02980-18	101	15-04028-20	105
14-02517-08	82	14-02679-13	89	15-02796-18	95	15-02899-12	98	15-02980-21	101	15-04032-18	106
14-02520-10	83	14-02683-20	90	15-02796-20	95	15-02899-15	98	15-02980-25	101	15-04032-20	106
14-02521-10	83	14-02687-23	90	15-02796-25	95	15-02899-18	98	15-02980-31	101	15-04032-25	106
14-02524-11	83	14-02691-23	90	15-02796-30	95	15-02902-18	98	15-02984-14	101	15-04036-18	106
14-02525-11	83	14-02695-22	90	15-02797-11	95	15-02903-18	98	15-02988-13	101	15-04038-18	106
14-02528-11	83	14-02699-22	90	15-02797-13	95	15-02906-14	98	15-02988-14	101	15-04042-15	106
14-02529-11	83	14-02701-21	90	15-02797-14	95	15-02908-18	98	15-02988-15	101	15-04042-18	106
14-02532-11	83	14-02703-24	90	15-02797-16	95	15-02912-20	98	15-02992-15	101	15-04042-23	106
14-02533-11	83	14-02705-23	90	15-02797-18	95	15-02916-18	99	15-02996-15	101	15-04046-18	106
14-02536-11	84	14-02705-26	90	15-02797-20	95	15-02917-18	99	15-03000-13	101	15-04050-03	106
14-02536-13	84	14-02705-37	90	15-02797-25	95	15-02920-18	99	15-03000-15	101	15-04050-04	106
14-02537-11	84	14-02708-10	91	15-02797-30	95	15-02923-18	99	15-03004-12	102	15-04050-05	106
14-02537-13	84	14-02709-10	91	15-02802-13	95	15-02927-18	99	15-03004-15	102	15-04050-07	106
14-02541-21	84	14-02712-10	91	15-02802-15	95	15-02929-18	99	15-03008-12	102	15-04054-10	107
14-02543-21	84	14-02713-10	91	15-02802-17	95	15-02932-15	99	15-03008-15	102	15-04055-10	107
14-02547-14	84	14-02716-10	91	15-02802-20	95	15-02932-23	99	15-03012-12	102	15-04057-10	107
14-02547-17	84	14-02720-12	91	15-02806-11	95	15-02932-25	99	15-03012-15	102	15-04060-10	107
14-02551-22	84	14-02721-12	91	15-02806-13	95	15-02936-18	99	15-03016-12	102	15-04061-10	107
14-02553-22	84	14-02724-13	92	15-02806-14	95	15-02936-23	99	15-03020-13	102	15-04063-10	107
14-02555-17	84	14-02725-13	92	15-02806-15	95	15-02940-18	99	15-03020-15	102	15-04066-09	107
14-02559-14	85	14-02729-14	92	15-02806-16	95	15-02940-21	99	15-03024-12	102	15-04066-10	107
14-02563-09	85	14-02733-13	92	15-02806-18	95	15-02940-25	99	15-03024-15	102	15-04066-11	107
14-02565-10	85	14-02737-11	92	15-02806-20	95	15-02944-18	99	15-03028-12	102	15-04066-12	107
14-02565-12	85	14-02740-12	92	15-02810-12	95	15-02944-21	99	15-03028-15	102	15-04067-09	107
14-02567-11	85	14-02741-12	92	15-02810-13	95	15-02944-25	99	15-03032-12	102	15-04067-10	107
14-02567-16	85	14-02745-17	92	15-02810-14	95	15-02948-15	99	15-03036-12	102	15-04067-11	107
14-02571-09	85	14-02747-17	92	15-02810-15	95	15-02948-18	99	15-03040-12	102	15-04067-12	107
14-02575-12	85	14-02751-16	93	15-02810-18	95	15-02948-20	99	15-03041-12	102	15-04070-09	107
14-02579-11	85	14-02753-16	93	15-02810-21	95	15-02948-23	99	15-03046-15	103	15-04070-10	107
14-02583-11	85	14-02758-14	93	15-02810-25	95	15-02948-25	99	15-03050-15	103	15-04070-11	107
14-02587-15	86	14-02759-14	93	15-02810-30	95	15-02952-10	100	15-03054-15	103	15-04070-12	107
14-02591-10	86	14-02763-12	93	15-02814-12	95	15-02952-11	100	15-03054-20	103	15-04071-09	107

**15**



**15**

Cat #	Pg #	Cat #	Pg #	Cat #	Pg #	Cat #	Pg #	Cat #	Pg #	Cat #	Pg #
15-04071-10	107	15-04196-22	112	16-04302-12	117	16-04394-16	121	16-04495-22	126	16-04619-14	132
15-04071-11	107	15-04198-18	112	16-04303-10	117	16-04394-18	121	16-04495-24	126	16-04619-18	132
15-04071-12	107	15-04198-22	112	16-04303-12	117	16-04394-20	121	16-04497-19	126	16-04621-14	132
15-04074-07	108	15-04200-18	112	16-04306-10	117	16-04394-22	121	16-04497-22	126	16-04621-18	132
15-04074-09	108	15-04200-22	112	16-04306-12	117	16-04394-24	121	16-04497-24	126	16-04625-15	132
15-04074-11	108	15-04203-22	113	16-04307-10	117	16-04394-26	121	16-04499-19	126	16-04625-19	132
15-04078-10	108	15-04203-24	113	16-04307-12	117	16-04394-30	121	16-04499-22	126	16-04629-15	132
15-04079-10	108	15-04205-22	113	16-04310-13	117	16-04395-13	121	16-04499-24	126	16-04629-19	132
15-04082-10	108	15-04205-24	113	16-04311-13	117	16-04395-14	121	16-04502-24	127	16-04633-18	132
15-04083-10	108	15-04207-24	113	16-04315-12	118	16-04395-16	121	16-04503-24	127	16-04633-23	133
15-04087-11	108	15-04209-22	113	16-04318-18	118	16-04395-18	121	16-04507-22	127	16-04637-22	133
15-04090-13	108	15-04211-22	113	16-04318-21	118	16-04395-20	121	16-04507-23	127	16-04637-25	133
15-04091-13	108	15-04213-22	113	16-04319-18	118	16-04395-22	121	16-04507-24	127	16-04637-28	133
15-04094-13	108	15-04215-22	113	16-04319-21	118	16-04395-24	121	16-04511-18	127	16-04641-22	133
15-04095-13	108	15-04219-16	114	16-04322-18	118	16-04395-26	121	16-04511-24	127	16-04645-20	133
15-04098-15	108	15-04219-18	114	16-04322-21	118	16-04395-30	121	16-04515-19	127	16-04649-24	133
15-04099-15	108	15-04219-20	114	16-04323-18	118	16-04398-13	122	16-04515-24	127	16-04653-22	134
15-04102-14	109	15-04219-22	114	16-04323-21	118	16-04402-15	122	16-04515-26	127	16-04657-27	134
15-04106-12	109	15-04219-24	114	16-04326-14	118	16-04402-19	122	16-04519-23	128	16-04661-19	134
15-04108-12	109	15-04221-16	114	16-04327-14	118	16-04402-24	122	16-04521-23	128	16-04663-23	134
15-04111-12	109	15-04221-18	114	16-04330-16	118	16-04403-15	122	16-04523-23	128	16-04664-13	134
15-04115-12	109	15-04221-20	114	16-04331-16	118	16-04403-19	122	16-04525-23	128	16-04664-15	134
15-04118-09	109	15-04221-22	114	16-04334-14	119	16-04403-24	122	16-04527-23	128	16-04664-18	134
15-04121-10	109	15-04221-24	114	16-04335-14	119	16-04406-16	122	16-04531-20	128	16-04664-20	134
15-04124-07	109	15-04223-18	114	16-04338-16	119	16-04406-20	122	16-04534-29	128	16-04664-23	134
15-04128-08	110			16-04339-16	119	16-04407-16	122	16-04535-29	128	16-04665-13	134
15-04128-09	110			16-04342-14	119	16-04407-20	122	16-04537-29	128	16-04665-15	134
15-04132-09	110			16-04343-14	119	16-04410-12	122	16-04541-13	128	16-04665-18	134
15-04136-09	110			16-04346-14	119	16-04412-12	122	16-04545-18	129	16-04665-20	134
15-04140-09	110	16-04226-03	115	16-04347-14	119	16-04415-14	122	16-04547-20	129	16-04665-23	134
15-04144-10	110	16-04226-05	115	16-04350-16	119	16-04416-14	122	16-04549-21	129	16-04668-13	134
15-04145-10	110	16-04227-03	115	16-04351-16	119	16-04420-15	123	16-04551-21	129	16-04668-14	134
15-04148-10	110	16-04227-05	115	16-04354-14	119	16-04424-16	123	16-04553-24	129	16-04668-15	134
15-04154-16	111	16-04230-06	115	16-04355-14	119	16-04426-16	123	16-04557-18	129	16-04668-18	134
15-04154-20	111	16-04231-06	115	16-04358-14	120	16-04430-15	123	16-04559-20	129	16-04668-20	134
15-04154-24	111	16-04234-01	115	16-04359-14	120	16-04430-18	123	16-04561-21	129	16-04668-23	134
15-04154-30	111	16-04234-02	115	16-04362-16	120	16-04431-15	123	16-04563-21	129	16-04669-13	134
15-04156-16	111	16-04234-03	115	16-04363-16	120	16-04431-18	123	16-04567-21	130	16-04669-15	134
15-04156-20	111	16-04234-04	115	16-04367-16	120	16-04435-19	123	16-04567-27	130	16-04669-18	134
15-04156-24	111	16-04234-05	115	16-04370-15	120	16-04438-18	124	16-04569-21	130	16-04669-20	134
15-04156-30	111	16-04234-06	115	16-04371-15	120	16-04439-18	124	16-04569-27	130	16-04669-23	134
15-04158-16	111	16-04234-07	115	16-04374-15	120	16-04442-18	124	16-04571-21	130	16-04672-22	135
15-04158-20	111	16-04235-01	115	16-04375-15	120	16-04443-18	124	16-04571-27	130	16-04672-25	135
15-04158-24	111	16-04235-02	115	16-04378-14	120	16-04446-18	124	16-04573-21	130	16-04673-22	135
15-04158-30	111	16-04235-03	115	16-04379-14	120	16-04446-20	124	16-04573-27	130	16-04673-24	135
15-04160-16	111	16-04235-04	115	16-04382-13	121	16-04449-14	124	16-04575-21	130	16-04675-21	135
15-04160-20	111	16-04235-05	115	16-04382-14	121	16-04451-18	124	16-04575-25	130	16-04675-24	135
15-04160-24	111	16-04235-06	115	16-04382-16	121	16-04454-18	124	16-04577-21	130	16-04679-20	135
15-04160-30	111	16-04235-07	115	16-04383-13	121	16-04455-18	124	16-04577-27	130	16-04679-23	135
15-04161-16	111	16-04237-24	115	16-04383-14	121	16-04457-18	124	16-04579-21	130	16-04683-19	135
15-04161-20	111	16-04240-10	115	16-04383-16	121	16-04461-19	125	16-04579-27	130	16-04683-21	135
15-04161-24	111	16-04242-13	115	16-04386-13	121	16-04463-19	125	16-04581-21	130	16-04683-23	135
15-04161-30	111	16-04246-13	115	16-04386-14	121	16-04467-19	125	16-04584-20	130	16-04685-19	135
15-04164-12	111	16-04250-15	115	16-04386-16	121	16-04469-19	125	16-04585-20	130	16-04685-21	135
15-04164-15	111	16-04254-10	116	16-04387-13	121	16-04474-19	125	16-04587-20	130	16-04685-23	135
15-04167-11	111	16-04258-15	116	16-04387-14	121	16-04475-19	125	16-04589-20	130	16-04687-21	135
15-04167-12	111	16-04258-20	116	16-04387-16	121	16-04478-20	125	16-04591-20	130	16-04690-21	136
15-04167-15	111	16-04262-12	116	16-04390-13	121	16-04478-22	125	16-04595-27	131	16-04691-21	136
15-04167-18	111	16-04266-14	116	16-04390-14	121	16-04478-24	125	16-04598-21	131	16-04695-19	136
15-04171-12	111	16-04266-16	116	16-04390-16	121	16-04478-26	125	16-04598-27	131	16-04697-19	136
15-04175-14	111	16-04270-14	116	16-04390-18	121	16-04479-20	125	16-04599-21	131	16-04700-21	136
15-04177-14	111	16-04274-15	116	16-04390-20	121	16-04479-22	125	16-04599-27	131	16-04701-21	136
15-04181-16	111	16-04278-14	116	16-04390-22	121	16-04479-24	125	16-04602-21	131	16-04704-16	136
15-04181-18	111	16-04282-16	116	16-04390-24	121	16-04479-26	125	16-04602-27	131	16-04704-20	136
15-04181-20	111	16-04286-10	117	16-04390-26	121	16-04482-20	125	16-04603-21	131	16-04705-16	136
15-04183-16	111	16-04287-10	117	16-04390-30	121	16-04482-22	125	16-04603-27	131	16-04705-20	136
15-04183-18	111	16-04290-10	117	16-04391-13	121	16-04482-24	125	16-04607-18	131	16-04709-21	137
15-04183-20	111	16-04291-10	117	16-04391-14	121	16-04482-26	125	16-04611-13	131	16-04713-19	137
15-04187-03	112	16-04294-12	117	16-04391-16	121	16-04483-20	125	16-04611-18	131	16-04717-21	137
15-04187-05	112	16-04294-14	117	16-04391-18	121	16-04483-22	125	16-04611-20	131	16-04721-23	137
15-04189-03	112	16-04295-12	117	16-04391-20	121	16-04483-24	125	16-04611-23	131	16-04723-24	137
15-04189-05	112	16-04295-14	117	16-04391-22	121	16-04483-26	125	16-04611-25	131	16-04726-23	137
15-04191-03	112	16-04298-12	117	16-04391-24	121	16-04486-27	126	16-04611-27	131	16-04727-23	137
15-04191-05	112	16-04298-14	117	16-04391-26	121	16-04487-27	126	16-04615-18	132	16-04730-17	137
15-04194-16	112	16-04299-12	117	16-04391-30	121	16-04490-22	126	16-04615-22	132	16-04733-14	138
15-04194-22	112	16-04299-14	117	16-04394-13	121	16-04491-22	126	16-04615-25	132	16-04736-25	138
15-04196-16	112	16-04302-10	117	16-04394-14	121	16-04495-19	126	16-04615-28	132	16-04739-21	138



## 16

Cat #	Pg #	Cat #	Pg #	Cat #	Pg #	Cat #	Pg #	Cat #	Pg #	Cat #	Pg #
16-04743-24	138	16-04894-13	145	17-05006-16	151	17-05097-02	155	17-05214-01	160	17-05287-08	164
16-04747-25	139	16-04896-13	145	17-05010-08	151	17-05097-03	155	17-05214-02	160	17-05301-20	164
16-04751-23	139	16-04900-20	146	17-05010-10	151	17-05097-04	155	17-05218-00	160	17-05302-20	164
16-04753-23	139	16-04900-25	146	17-05010-12	151	17-05098-01	155	17-05218-01	160	17-05305-14	164
16-04755-22	139	16-04901-20	146	17-05010-14	151	17-05098-02	155	17-05218-02	160	17-05308-03	165
16-04757-22	139	16-04901-25	146	17-05010-16	151	17-05098-03	155	17-05218-03	160	17-05308-04	165
16-04761-22	139	16-04904-20	146	17-05010-18	151	17-05098-04	155	17-05222-13	160	17-05311-02	165
16-04765-18	140	16-04904-25	146	17-05014-12	151	17-05101-04	155	17-05224-14	160	17-05311-03	165
16-04769-14	140	16-04905-20	146	17-05014-14	151	17-05102-04	155	17-05228-19	160	17-05311-04	165
16-04773-18	140	16-04905-25	146	17-05014-16	151	17-05106-02	156	17-05232-21	160	17-05311-06	165
16-04773-20	140	16-04908-25	146	17-05014-18	151	17-05109-13	156	17-05236-13	160	17-05312-02	165
16-04777-20	140	16-04909-25	146	17-05017-16	151	17-05113-14	156	17-05240-18	160	17-05312-03	165
16-04781-18	140	16-04912-28	146	17-05018-16	151	17-05117-16	156	17-05244-16	161	17-05312-04	165
16-04785-18	141	16-04913-28	146	17-05021-16	151	17-05119-16	156	17-05248-12	161	17-05312-06	165
16-04789-20	141	16-04916-20	146	17-05023-16	151	17-05122-18	156	17-05250-15	161	17-05316-20	166
16-04791-20	141	16-04917-20	146	17-05025-16	151	17-05124-18	156	17-05254-16	161	17-05320-01	166
16-04794-24	141	16-04920-25	147	17-05029-16	151	17-05126-18	156	17-05256-15	161	17-05320-02	166
16-04795-24	141	16-04924-25	147	17-05031-16	151	17-05128-18	156	17-05260-19	161	17-05320-03	166
16-04799-20	141	16-04928-21	147	17-05035-16	151	17-05130-18	156	17-05263-22	162	17-05320-04	166
16-04801-20	141	16-04932-26	147	17-05037-16	151	17-05132-18	156	17-05264-22	162	17-05324-23	166
16-04805-20	141	16-04935-26	147	17-05040-10	152	17-05135-02	156	17-05267-23	162	17-05327-28	167
16-04808-09	142	16-04937-26	147	17-05040-17	152	17-05135-03	156	17-05268-23	162	17-05331-24	167
16-04812-05	142	16-04941-26	148	17-05040-20	152	17-05135-04	156	17-05273-01	162	17-05332-24	167
16-04812-09	142	16-04944-18	148	17-05040-22	152	17-05135-06	156	17-05273-02	162	17-05335-24	167
16-04816-09	142	16-04944-24	148	17-05043-01	152	17-05136-02	156	17-05273-03	162	17-05337-25	167
16-04820-09	142	16-04946-18	148	17-05043-02	152	17-05136-03	156	17-05273-04	162	17-05340-21	168
16-04820-11	142	16-04946-24	148	17-05043-03	152	17-05136-04	156	17-05273-06	162	17-05344-01	168
16-04820-13	142	16-04950-18	148	17-05043-04	152	17-05136-06	156	17-05273-08	162	17-05344-02	168
16-04820-15	142	16-04950-20	148	17-05044-01	152	17-05140-08	157	17-05274-01	162	17-05344-03	168
16-04824-11	142	16-04950-24	148	17-05044-02	152	17-05140-10	157	17-05274-02	162	17-05348-01	168
16-04824-13	142	16-04950-25	148	17-05044-03	152	17-05140-12	157	17-05274-03	162	17-05348-02	168
16-04825-14	142	16-04951-18	148	17-05044-04	152	17-05140-14	157	17-05274-04	162	17-05348-03	168
16-04832-10	142	16-04951-20	148	17-05047-02	152	17-05140-16	157	17-05274-06	162	17-05348-04	168
16-04832-13	142	16-04951-24	148	17-05047-03	152	17-05140-18	157	17-05274-08	162	17-05352-19	168
16-04836-10	143	16-04951-25	148	17-05047-04	152	17-05142-08	157	17-05275-01	162	17-05356-01	168
16-04836-15	143	16-04954-18	148	17-05048-02	152	17-05142-10	157	17-05275-02	162	17-05356-02	168
16-04840-10	143	16-04954-20	148	17-05048-03	152	17-05142-12	157	17-05275-03	162	17-05356-03	168
16-04840-13	143	16-04954-24	148	17-05048-04	152	17-05142-14	157	17-05275-04	162	17-05360-01	168
16-04844-16	143	16-04954-25	148	17-05051-04	152	17-05142-16	157	17-05275-06	162	17-05360-02	168
16-04848-20	143	16-04955-18	148	17-05052-04	152	17-05142-18	157	17-05275-08	162	17-05360-03	168
16-04852-18	143	16-04955-20	148	17-05055-03	153	17-05146-08	157	17-05279-01	163	17-05360-04	168
16-04856-14	144	16-04955-24	148	17-05057-05	153	17-05146-10	157	17-05279-02	163	17-05360-05	168
16-04856-15	144	16-04955-25	148	17-05059-07	153	17-05146-11	157	17-05279-03	163	17-05360-06	168
16-04856-18	144	16-04959-19	149	17-05063-15	153	17-05146-12	157	17-05279-04	163	17-05360-07	168
16-04856-20	144	16-04962-01	149	17-05065-15	153	17-05146-13	157	17-05279-06	163	17-05364-01	168
16-04860-14	144	16-04962-02	149	17-05069-11	153	17-05146-14	157	17-05280-01	163	17-05364-05	168
16-04864-16	144	16-04962-03	149	17-05072-17	153	17-05146-15	157	17-05280-02	163	17-05364-06	168
16-04864-18	144	16-04966-23	149	17-05076-17	153	17-05146-16	157	17-05280-03	163	17-05368-22	169
16-04868-15	144	16-04970-08	149	17-05080-08	154	17-05146-18	157	17-05280-04	163	17-05372-01	169
16-04868-18	144	16-04970-12	149	17-05080-11	154	17-05150-13	157	17-05280-06	163	17-05372-02	169
16-04868-20	144	16-04970-20	149	17-05080-15	154	17-05150-16	157	17-05281-01	163	17-05376-01	169
16-04872-50	144	16-04971-08	149	17-05080-17	154	17-05154-13	157	17-05281-02	163	17-05376-02	169
16-04872-60	144	16-04971-12	149	17-05080-20	154	17-05158-11	157	17-05281-03	163	17-05376-03	169
16-04872-70	144	16-04971-20	149	17-05080-23	154	17-05162-11	157	17-05281-04	163	17-05376-04	169
16-04872-80	144	16-04974-10	149	17-05082-08	154	17-05166-18	158	17-05281-06	163	17-05376-05	169
16-04876-13	144	16-04974-14	149	17-05082-11	154	17-05170-17	158	17-05285-24	163	17-05376-06	169
16-04876-17	144	16-04974-20	149	17-05082-15	154	17-05172-17	158	17-05287-21	163	17-05376-07	169
16-04876-20	144	16-04975-10	149	17-05082-17	154	17-05176-19	158	17-05288-21	163	17-05376-08	169
16-04876-25	144	16-04975-14	149	17-05082-20	154	17-05178-19	158	17-05291-21	163	17-05376-09	169
16-04876-30	144	16-04975-20	149	17-05082-23	154	17-05182-02	158	17-05292-21	163	17-05376-10	169
16-04880-13	144			17-05089-01	155	17-05182-03	158	17-05295-01	164	17-05380-21	169
16-04880-17	144			17-05089-02	155	17-05182-04	158	17-05295-02	164	17-05384-01	170
16-04880-20	144			17-05089-03	155	17-05186-20	158	17-05295-03	164	17-05384-02	170
16-04880-25	144	17-04979-13	150	17-05089-04	155	17-05190-16	159	17-05295-04	164	17-05384-03	170
16-04880-30	144	17-04980-13	150	17-05090-01	155	17-05192-16	159	17-05295-06	164	17-05384-04	170
16-04884-22	145	17-04984-20	150	17-05090-02	155	17-05195-16	159	17-05295-08	164	17-05384-05	170
16-04884-25	145	17-04988-19	150	17-05090-03	155	17-05196-16	159	17-05296-01	164	17-05388-01	170
16-04884-27	145	17-04988-28	150	17-05090-04	155	17-05200-16	159	17-05296-02	164	17-05388-02	170
16-04885-22	145	17-04990-19	150	17-05093-01	155	17-05204-15	159	17-05296-03	164	17-05388-03	170
16-04885-25	145	17-04990-28	150	17-05093-02	155	17-05206-15	159	17-05296-04	164	17-05388-04	170
16-04885-27	145	17-04993-15	150	17-05093-03	155	17-05209-01	159	17-05296-06	164	17-05392-01	170
16-04888-13	145	17-04995-18	150	17-05093-04	155	17-05209-02	159	17-05296-08	164	17-05392-02	170
16-04888-15	145	17-04997-18	150	17-05094-01	155	17-05209-03	159	17-05297-01	164	17-05392-03	170
16-04888-18	145	17-05001-13	150	17-05094-02	155	17-05210-01	159	17-05297-02	164	17-05392-04	170
16-04890-13	145	17-05001-18	150	17-05094-03	155	17-05210-02	159	17-05297-03	164	17-05392-05	170
16-04890-15	145	17-05002-13	150	17-05094-04	155	17-05210-03	159	17-05297-04	164	17-05392-06	170
16-04890-18	145	17-05002-18	150	17-05097-01	155	17-05214-00	160	17-05297-06	164	17-05396-29	171

## 17



## 17

Cat #	Pg #	Cat #	Pg #	Cat #	Pg #	Cat #	Pg #	Cat #	Pg #	Cat #	Pg #
17-05396-32	171	17-05500-01	176	17-05590-02	181	17-05759-10	191	17-05872-01	198	17-05968-01	206
17-05396-33	171	17-05500-02	176	17-05590-03	181	17-05760-10	191	17-05876-00	198	17-05968-02	206
17-05400-01	171	17-05500-03	176	17-05590-04	181	17-05763-10	191	17-05876-01	198	17-05972-00	206
17-05400-02	171	17-05502-26	176	17-05590-05	181	17-05764-10	191	17-05876-02	198	17-05972-01	206
17-05400-03	171	17-05506-01	177	17-05590-06	181	17-05767-10	191	17-05876-03	198	17-05972-02	206
17-05402-01	171	17-05506-02	177	17-05594-01	182	17-05768-10	191	17-05878-00	198	17-05972-03	206
17-05402-02	171	17-05508-01	177	17-05594-02	182	17-05772-11	191	17-05878-01	198	17-05972-04	206
17-05402-03	171	17-05508-02	177	17-05600-01	182	17-05774-11	191	17-05878-02	198	17-05972-05	206
17-05406-21	172	17-05510-27	177	17-05600-02	182	17-05777-13	191	17-05880-00	198	17-05976-00	207
17-05410-17	172	17-05512-27	177	17-05604-01	182	17-05778-13	191	17-05880-01	198	17-05976-01	207
17-05414-01	172	17-05516-02	177	17-05604-02	182	17-05781-10	192	17-05880-02	198	17-05976-02	207
17-05414-02	172	17-05516-03	177	17-05608-01	183	17-05781-13	192	17-05880-03	198	17-05976-03	207
17-05418-22	172	17-05520-25	177	17-05608-02	183	17-05781-14	192	17-05884-00	199	17-05976-04	207
17-05422-01	172	17-05524-01	178	17-05608-03	183	17-05781-16	192	17-05884-01	199	17-05976-05	207
17-05422-02	172	17-05524-02	178	17-05608-04	183	17-05782-10	192	17-05884-02	199	17-05976-10	207
17-05422-03	172	17-05524-03	178	17-05608-05	183	17-05782-13	192	17-05884-03	199	17-05980-00	207
17-05422-04	172	17-05524-04	178	17-05608-06	183	17-05782-14	192	17-05886-01	199	17-05980-01	207
17-05424-01	172	17-05524-05	178	17-05612-01	184	17-05782-16	192	17-05886-02	199	17-05980-02	207
17-05424-02	172	17-05524-06	178	17-05612-02	184	17-05785-13	192	17-05890-00	200	17-05980-03	207
17-05424-03	172	17-05524-07	178	17-05612-03	184	17-05785-14	192	17-05890-01	200	17-05980-04	207
17-05426-01	173	17-05524-08	178	17-05616-01	185	17-05785-16	192	17-05890-02	200	17-05980-05	207
17-05426-02	173	17-05524-09	178	17-05616-02	185	17-05786-13	192	17-05890-03	200	17-05980-06	207
17-05426-03	173	17-05528-01	178	17-05620-15	185	17-05786-14	192	17-05894-00	200	17-05980-10	207
17-05430-01	173	17-05528-02	178	17-05624-16	185	17-05786-16	192	17-05894-01	200	17-05984-00	207
17-05430-02	173	17-05528-03	178	17-05627-10	186	17-05789-13	192	17-05894-02	200	17-05984-01	207
17-05430-03	173	17-05528-04	178	17-05627-20	186	17-05789-14	192	17-05894-03	200	17-05984-02	207
17-05430-04	173	17-05532-01	178	17-05629-17	186	17-05789-16	192	17-05898-16	200	17-05984-10	207
17-05434-00	173	17-05532-02	178	17-05632-17	186	17-05790-13	192	17-05902-09	200	17-05988-00	208
17-05434-01	173	17-05532-03	178	17-05636-21	186	17-05790-14	192	17-05902-11	200	17-05988-01	208
17-05434-02	173	17-05532-04	178	17-05640-18	186	17-05790-16	192	17-05902-13	200	17-05988-02	208
17-05438-01	173	17-05536-01	179	17-05644-01	186	17-05793-15	192	17-05902-19	200	17-05988-10	208
17-05438-02	173	17-05536-02	179	17-05644-02	186	17-05796-16	192	17-05904-19	200	17-05990-00	208
17-05438-03	173	17-05536-03	179	17-05648-00	186	17-05800-12	192	17-05908-01	200	17-05994-00	208
17-05438-04	173	17-05540-01	179	17-05652-21	187	17-05803-16	193	17-05908-02	200	17-05994-01	208
17-05442-01	174	17-05540-02	179	17-05658-20	187	17-05804-16	193	17-05908-03	200	17-05994-02	208
17-05442-02	174	17-05540-03	179	17-05662-17	187	17-05805-19	193	17-05908-04	200	17-05994-03	208
17-05442-03	174	17-05544-00	179	17-05668-05	187	17-05805-25	193	17-05912-18	201	17-05998-00	209
17-05446-04	174	17-05544-01	179	17-05668-07	187	17-05805-32	193	17-05914-18	201	17-05998-01	209
17-05450-01	174	17-05544-02	179	17-05668-09	187	17-05808-13	193	17-05918-19	201	17-05998-02	209
17-05454-01	174	17-05548-01	179	17-05672-06	187	17-05811-13	193	17-05922-12	201	17-05998-03	209
17-05454-02	174	17-05548-02	179	17-05672-07	187	17-05812-13	193	17-05922-17	201	17-05998-04	209
17-05454-03	174	17-05548-03	179	17-05672-09	187	17-05815-13	193	17-05926-00	201	17-05998-10	209
17-05454-04	174	17-05552-33	179	17-05672-11	187	17-05815-16	193	17-05928-01	201	17-06000-01	209
17-05458-01	175	17-05556-28	179	17-05676-18	187	17-05816-13	193	17-05928-02	201	17-06000-02	209
17-05458-02	175	17-05560-20	180	17-05680-23	187	17-05816-16	193	17-05932-00	202	17-06000-03	209
17-05458-03	175	17-05560-30	180	17-05686-10	188	17-05819-20	194	17-05932-01	202	17-06000-04	209
17-05458-04	175	17-05560-40	180	17-05687-10	188	17-05819-25	194	17-05932-02	202		
17-05458-05	175	17-05564-01	180	17-05690-01	188	17-05820-20	194	17-05936-00	202		
17-05462-25	175	17-05564-02	180	17-05690-02	188	17-05820-25	194	17-05940-00	202	18-06004-11	210
17-05466-01	175	17-05568-01	180	17-05694-07	188	17-05821-25	194	17-05944-00	203	18-06004-13	210
17-05466-02	175	17-05568-02	180	17-05694-10	188	17-05822-25	194	17-05944-01	203	18-06004-14	210
17-05466-03	175	17-05568-03	180	17-05698-02	188	17-05823-20	194	17-05944-02	203	18-06004-16	210
17-05466-04	175	17-05568-04	180	17-05698-04	188	17-05823-26	194	17-05944-03	203	18-06004-18	210
17-05466-05	175	17-05568-05	180	17-05702-16	188	17-05824-20	194	17-05944-04	203	18-06004-20	210
17-05466-06	175	17-05568-06	180	17-05706-21	188	17-05824-26	194	17-05948-00	203	18-06004-25	210
17-05470-22	175	17-05568-07	180	17-05708-21	188	17-05827-20	194	17-05948-01	203	18-06006-11	210
17-05472-01	175	17-05568-08	180	17-05712-30	189	17-05828-20	194	17-05948-02	203	18-06006-13	210
17-05472-02	175	17-05568-09	180	17-05716-29	189	17-05831-20	194	17-05948-03	203	18-06006-14	210
17-05472-03	175	17-05568-10	180	17-05720-14	189	17-05831-26	194	17-05948-04	203	18-06006-16	210
17-05476-23	175	17-05572-01	180	17-05722-23	189	17-05832-20	194	17-05948-05	203	18-06006-18	210
17-05480-01	175	17-05572-02	180	17-05724-18	189	17-05832-26	194	17-05948-06	203	18-06006-20	210
17-05480-02	175	17-05572-03	180	17-05726-15	189	17-05836-21	195	17-05948-07	203	18-06006-25	210
17-05484-28	176	17-05572-04	180	17-05728-18	189	17-05839-01	195	17-05948-08	203	18-06008-11	210
17-05488-26	176	17-05572-05	180	17-05732-14	189	17-05839-02	195	17-05948-09	203	18-06008-13	210
17-05492-01	176	17-05572-06	180	17-05736-07	190	17-05840-01	195	17-05952-00	204	18-06008-14	210
17-05492-02	176	17-05572-07	180	17-05739-05	190	17-05840-02	195	17-05952-01	204	18-06008-16	210
17-05492-03	176	17-05572-08	180	17-05739-07	190	17-05843-27	195	17-05952-02	204	18-06008-18	210
17-05492-04	176	17-05574-01	180	17-05740-05	190	17-05844-27	195	17-05956-00	204	18-06008-20	210
17-05492-05	176	17-05574-02	180	17-05740-07	190	17-05847-27	195	17-05956-01	204	18-06008-25	210
17-05492-06	176	17-05574-03	180	17-05743-07	190	17-05848-27	196	17-05956-02	204	18-06010-14	210
17-05492-07	176	17-05578-28	180	17-05746-08	190	17-05851-31	196	17-05960-00	205	18-06010-16	210
17-05496-01	176	17-05582-01	181	17-05746-11	190	17-05852-31	196	17-05960-01	205	18-06012-11	210
17-05496-02	176	17-05582-02	181	17-05750-09	190	17-05856-33	196	17-05960-02	205	18-06012-13	210
17-05496-03	176	17-05586-01	181	17-05753-07	190	17-05861-27	196	17-05964-00	205	18-06012-14	210
17-05496-04	176	17-05586-02	181	17-05753-10	190	17-05864-33	197	17-05964-01	205	18-06012-16	210
17-05496-05	176	17-05586-03	181	17-05756-07	190	17-05868-00	197	17-05964-02	205	18-06012-18	210
17-05496-06	176	17-05590-01	181	17-05756-10	190	17-05872-00	197	17-05968-00	206	18-06012-20	210

## 18

18-06004-11	210
18-06004-13	210
18-06004-14	210
18-06004-16	210
18-06004-18	210
18-06004-20	210
18-06004-25	210
18-06006-11	210
18-06006-13	210
18-06006-14	210
18-06006-16	210
18-06006-18	210
18-06006-20	210
18-06006-25	210
18-06008-11	210
18-06008-13</	



**18**

Cat #	Pg #	Cat #	Pg #	Cat #	Pg #	Cat #	Pg #	Cat #	Pg #	Cat #	Pg #
18-06016-13	210	18-06116-06	214	19-06219-23	222	19-06342-26	230	19-06476-31	236	19-06607-14	243
18-06016-18	210	18-06116-09	214	19-06222-18	223	19-06342-30	230	19-06480-15	237	19-06609-16	243
18-06020-14	210	18-06116-12	214	19-06222-21	223	19-06343-16	230	19-06484-15	237	19-06612-01	244
18-06020-18	210	18-06116-15	214	19-06222-23	223	19-06343-18	230	19-06488-15	237	19-06612-02	244
18-06024-11	210	18-06120-00	215	19-06223-18	223	19-06343-20	230	19-06492-18	237	19-06617-01	244
18-06024-13	210	18-06120-02	215	19-06223-21	223	19-06343-24	230	19-06492-20	237	19-06617-02	244
18-06024-14	210	18-06120-03	215	19-06223-23	223	19-06343-26	230	19-06492-23	237	19-06622-01	244
18-06024-16	210	18-06120-04	215	19-06226-12	224	19-06343-30	230	19-06492-26	237	19-06622-02	244
18-06024-18	210	18-06120-06	215	19-06227-12	224	19-06347-21	230	19-06492-31	237	19-06627-01	244
18-06024-20	210	18-06120-07	215	19-06229-12	224	19-06350-16	230	19-06496-13	237	19-06627-02	244
18-06025-14	210	18-06120-08	215	19-06232-12	224	19-06350-18	230	19-06498-16	237	19-06632-01	245
18-06028-13	210	18-06120-10	215	19-06233-12	224	19-06350-20	230	19-06502-12	237	19-06632-02	245
18-06028-14	210	18-06120-12	215	19-06235-12	224	19-06354-16	230	19-06506-13	237	19-06637-01	245
18-06028-16	210	18-06120-14	215	19-06238-14	225	19-06354-18	230	19-06510-14	238	19-06637-02	245
18-06028-18	210	18-06124-40	215	19-06239-14	225	19-06354-20	230	19-06510-18	238	19-06642-01	245
18-06032-13	210	18-06124-50	215	19-06242-13	225	19-06358-17	231	19-06510-20	238	19-06642-02	245
18-06032-14	210	18-06124-65	215	19-06242-15	225	19-06362-18	231	19-06510-23	238	19-06648-01	246
18-06032-16	210	18-06124-80	215	19-06246-14	225	19-06362-26	231	19-06514-13	238	19-06648-02	246
18-06032-20	210	18-06128-03	215	19-06248-13	225	19-06365-27	231	19-06514-15	238	19-06653-01	246
18-06033-16	210	18-06128-04	215	19-06250-14	225	19-06368-27	231	19-06514-18	238	19-06653-02	246
18-06036-10	210	18-06128-05	215	19-06254-12	226	19-06372-23	231	19-06514-20	238	19-06658-01	246
18-06040-16	210	18-06128-06	215	19-06255-12	226	19-06376-27	231	19-06514-23	238	19-06658-02	246
18-06044-25	211	18-06132-18	215	19-06258-12	226	19-06380-15	232	19-06514-26	238	19-06664-01	247
18-06044-30	211	18-06132-21	215	19-06259-12	226	19-06384-15	232	19-06516-13	238	19-06664-02	247
18-06044-40	211	18-06136-14	215	19-06262-13	226	19-06388-18	232	19-06516-15	238	19-06664-03	247
18-06048-13	211	18-06136-24	215	19-06266-12	226	19-06392-17	232	19-06516-18	238	19-06672-01	247
18-06048-14	211			19-06270-16	226	19-06392-20	232	19-06516-20	238	19-06672-02	247
18-06052-23	211			19-06271-16	226	19-06396-11	232	19-06516-23	238	19-06677-01	247
18-06054-28	211			19-06274-14	227	19-06398-14	232	19-06516-26	238	19-06677-02	247
18-06058-16	211			19-06274-18	227	19-06398-18	232	19-06520-15	238	19-06685-01	247
18-06062-01	211	19-06140-14	216	19-06274-21	227	19-06400-17	232	19-06520-17	238	19-06685-02	247
18-06062-02	211	19-06141-14	216	19-06275-14	227	19-06404-14	233	19-06520-20	238	19-06690-32	248
18-06062-03	211	19-06144-14	216	19-06275-18	227	19-06406-16	233	19-06524-18	238	19-06694-21	248
18-06062-04	211	19-06144-18	216	19-06275-21	227	19-06408-14	233	19-06524-20	238	19-06698-20	248
18-06070-01	211	19-06145-14	216	19-06278-14	227	19-06412-15	233	19-06528-26	239	19-06702-19	248
18-06070-02	211	19-06145-18	216	19-06278-18	227	19-06416-18	233	19-06532-27	239	19-06705-01	249
18-06070-03	211	19-06148-09	216	19-06278-21	227	19-06420-20	233	19-06534-27	239	19-06705-02	249
18-06074-12	212	19-06149-09	216	19-06279-14	227	19-06424-18	233	19-06537-20	239	19-06705-03	249
18-06074-16	212	19-06152-14	216	19-06279-18	227	19-06428-14	234	19-06537-27	239	19-06705-21	249
18-06074-18	212	19-06153-14	216	19-06279-21	227	19-06428-17	234	19-06540-14	240	19-06707-25	249
18-06075-18	212	19-06156-09	217	19-06282-14	227	19-06428-20	234	19-06540-17	240	19-06711-01	249
18-06076-18	212	19-06157-09	217	19-06284-14	227	19-06430-14	234	19-06540-20	240	19-06711-02	249
18-06078-16	212	19-06160-14	217	19-06288-14	227	19-06430-17	234	19-06540-24	240	19-06711-03	249
18-06080-13	212	19-06161-14	217	19-06292-13	227	19-06430-20	234	19-06542-14	240	19-06711-04	249
18-06080-18	212	19-06164-11	217	19-06296-18	227	19-06434-14	235	19-06542-17	240	19-06715-01	250
18-06084-14	212	19-06168-18	217	19-06298-18	227	19-06434-17	235	19-06542-20	240	19-06715-02	250
18-06084-16	212	19-06168-21	217	19-06302-14	228	19-06434-20	235	19-06542-24	240	19-06715-03	250
18-06086-14	212	19-06170-18	217	19-06303-14	228	19-06438-13	235	19-06544-17	240	19-06715-04	250
18-06086-16	212	19-06170-21	217	19-06306-14	228	19-06440-13	235	19-06544-20	240	19-06717-01	250
18-06090-12	212	19-06174-20	218	19-06306-18	228	19-06444-13	235	19-06548-16	240	19-06717-02	250
18-06090-14	212	19-06174-22	218	19-06306-23	228	19-06448-12	235	19-06548-18	240	19-06717-03	250
18-06090-16	212	19-06175-16	218	19-06310-16	228	19-06452-18	235	19-06548-20	240	19-06717-04	250
18-06090-18	212	19-06175-20	218	19-06310-18	228	19-06456-20	235	19-06650-18	240	19-06720-25	251
18-06092-12	212	19-06175-22	218	19-06310-20	228	19-06456-24	235	19-06650-20	240	19-06724-22	251
18-06092-14	212	19-06175-24	218	19-06310-23	228	19-06456-26	235	19-06554-20	240	19-06726-22	251
18-06092-16	212	19-06178-16	218	19-06310-25	228	19-06460-16	236	19-06558-18	241	19-06730-24	251
18-06092-18	212	19-06178-18	218	19-06311-16	228	19-06460-16	236	19-06562-14	241	19-06734-01	252
18-06094-12	212	19-06179-16	218	19-06311-18	228	19-06460-18	236	19-06562-17	241	19-06734-02	252
18-06094-14	212	19-06179-18	218	19-06311-20	228	19-06460-20	236	19-06562-20	241	19-06734-03	252
18-06094-16	212	19-06182-15	219	19-06311-23	228	19-06460-24	236	19-06566-18	241	19-06734-04	252
18-06094-18	212	19-06183-15	219	19-06311-25	228	19-06460-26	236	19-06570-20	241	19-06738-01	252
18-06098-28	213	19-06186-18	219	19-06314-13	229	19-06460-30	236	19-06570-23	241	19-06738-02	252
18-06098-38	213	19-06187-18	219	19-06315-13	229	19-06461-20	236	19-06574-20	242	19-06738-03	252
18-06100-28	213	19-06190-18	219	19-06318-13	229	19-06461-24	236	19-06574-25	242	19-06738-04	252
18-06100-38	213	19-06194-18	220	19-06322-12	229	19-06461-26	236	19-06578-20	242	19-06742-25	252
18-06104-36	213	19-06194-22	220	19-06324-12	229	19-06464-14	236	19-06578-24	242	19-06746-28	252
18-06108-01	213	19-06195-18	220	19-06326-12	229	19-06470-20	236	19-06582-17	242	19-06750-18	253
18-06108-02	213	19-06195-22	220	19-06330-14	229	19-06470-24	236	19-06582-20	242	19-06750-27	253
18-06108-03	213	19-06198-15	221	19-06334-13	229	19-06474-18	236	19-06586-16	242	19-06754-19	253
18-06112-00	214	19-06199-15	221	19-06338-18	229	19-06474-20	236	19-06586-16	242	19-06756-19	253
18-06112-01	214	19-06206-15	221	19-06338-18	229	19-06474-23	236	19-06590-12	242	19-06760-19	254
18-06112-02	214	19-06207-15	221	19-06342-13	230	19-06474-26	236	19-06594-20	242	19-06762-19	254
18-06112-03	214	19-06210-18	222	19-06342-14	230	19-06474-31	236	19-06594-25	242	19-06764-20	254
18-06112-06	214	19-06211-18	222	19-06342-16	230	19-06476-18	236	19-06598-11	243	19-06768-23	254
18-06112-09	214	19-06214-18	222	19-06342-18	230	19-06476-20	236	19-06600-14	243	19-06772-21	254
18-06112-12	214	19-06215-18	222	19-06342-20	230	19-06476-23	236	19-06602-17	243	19-06776-23	254
18-06112-15	214	19-06218-23	222	19-06342-24	230	19-06476-26	236	19-06604-18	243	19-06780-12	255



**19**

Cat #	Pg #	Cat #	Pg #	Cat #	Pg #	Cat #	Pg #	Cat #	Pg #	Cat #	Pg #
19-06782-12	255	21-06874-12	258	21-06915-16	260	21-06938-10	261	21-06966-06	263	21-06993-04	266
19-06786-12	255	21-06874-14	258	21-06915-19	260	21-06938-15	261	21-06966-09	263	21-06993-05	266
19-06788-12	255	21-06874-16	258	21-06915-25	260	21-06938-20	261	21-06966-13	263	21-06993-06	266
19-06790-13	255	21-06878-06	258	21-06915-32	260	21-06938-25	261	21-06966-16	263	21-06993-10	266
19-06792-13	255	21-06878-12	258	21-06918-06	260	21-06938-30	261	21-06966-19	263	21-06993-20	266
19-06796-12	255	21-06878-18	258	21-06918-09	260	21-06942-20	262	21-06966-25	263	21-06993-30	266
19-06798-12	255	21-06880-06	258	21-06918-14	260	21-06943-20	262	21-06966-32	263	21-06996-01	267
19-06802-14	255	21-06880-12	258	21-06918-16	260	21-06944-22	262	21-06967-06	263	21-06996-02	267
19-06806-14	255	21-06880-18	258	21-06918-19	260	21-06948-05	263	21-06967-09	263	21-06996-03	267
19-06810-17	255	21-06882-06	258	21-06918-25	260	21-06948-09	263	21-06967-13	263	21-06996-04	267
19-06812-17	255	21-06882-12	258	21-06918-32	260	21-06950-06	263	21-06967-16	263	21-06996-05	267

**20**

20-06816-20	256	21-06886-05	258	21-06919-25	260	21-06950-15	263	21-06967-25	263	21-06996-10	267
20-06820-18	256	21-06886-07	258	21-06919-32	260	21-06950-20	263	21-06967-32	263	21-06996-20	267
20-06824-18	256	21-06886-09	258	21-06922-04	261	21-06950-25	263	21-06967-32	263	21-06996-30	267
20-06828-14	256	21-06890-02	258	21-06922-06	261	21-06950-30	263	21-06970-05	264	21-06996-20	267
20-06832-28	256	21-06890-03	258	21-06922-08	261	21-06952-06	263	21-06970-10	264	21-06998-01	267
20-06836-30	256	21-06893-10	259	21-06922-10	261	21-06952-08	263	21-06970-15	264	21-06998-02	267
20-06840-28	256	21-06893-15	259	21-06922-13	261	21-06952-10	263	21-06972-05	264	21-06998-03	267
20-06844-23	256	21-06893-20	259	21-06922-16	261	21-06952-12	263	21-06972-10	264	21-06998-04	267
20-06848-18	257	21-06893-25	259	21-06922-18	261	21-06952-15	263	21-06972-15	264	21-06998-05	267
20-06848-24	257	21-06893-30	259	21-06922-20	261	21-06952-20	263	21-06973-05	264	21-06998-06	267
20-06852-24	257	21-06895-10	259	21-06922-25	261	21-06952-25	263	21-06973-10	264	21-06998-10	267
20-06856-23	257	21-06895-15	259	21-06922-30	261	21-06952-30	263	21-06973-15	264	21-06998-20	267
20-06856-26	257	21-06895-20	259	21-06922-38	261	21-06953-06	263	21-06976-01	264	21-06998-30	267
20-06856-37	257	21-06895-25	259	21-06922-44	261	21-06953-08	263	21-06977-02	264	21-07002-02	267

**21**

21-06860-02	258	21-06898-05	259	21-06923-04	261	21-06953-12	263	21-06977-03	264	21-07002-03	267
21-06860-03	258	21-06898-06	259	21-06923-06	261	21-06953-15	263	21-06977-04	264	21-07002-04	267
21-06860-04	258	21-06898-07	259	21-06923-08	261	21-06953-20	263	21-06980-01	265	21-07002-05	267
21-06860-05	258	21-06898-08	259	21-06923-10	261	21-06953-25	263	21-06980-02	265	21-07002-06	267
21-06860-06	258	21-06898-10	259	21-06923-13	261	21-06953-30	263	21-06980-03	265	21-07002-07	267
21-06860-07	258	21-06898-15	259	21-06923-16	261	21-06956-06	263	21-06980-04	265	21-07002-08	267
21-06860-08	258	21-06900-05	259	21-06923-18	261	21-06956-08	263	21-06980-05	265	21-07002-10	267
21-06862-02	258	21-06900-06	259	21-06923-20	261	21-06956-10	263	21-06980-06	265	21-07002-12	267
21-06862-03	258	21-06900-07	259	21-06923-25	261	21-06956-15	263	21-06980-10	265	21-07004-02	267
21-06862-04	258	21-06900-08	259	21-06923-38	261	21-06956-20	263	21-06980-20	265	21-07004-02	267
21-06862-05	258	21-06900-10	259	21-06923-44	261	21-06956-25	263	21-06980-30	265	21-07004-03	267
21-06862-06	258	21-06904-04	260	21-06923-50	261	21-06957-08	263	21-06980-40	265	21-07004-04	267
21-06862-07	258	21-06904-06	260	21-06926-02	261	21-06957-12	263	21-06984-01	265	21-07004-05	267
21-06862-08	258	21-06904-10	260	21-06926-03	261	21-06957-15	263	21-06984-02	265	21-07004-06	267
21-06866-02	258	21-06904-12	260	21-06926-06	261	21-06957-20	263	21-06984-03	265	21-07004-07	267
21-06866-03	258	21-06904-14	260	21-06926-08	261	21-06957-25	263	21-06984-04	265	21-07004-08	267
21-06866-04	258	21-06906-04	260	21-06926-10	261	21-06957-30	263	21-06984-05	265	21-07004-10	267
21-06866-05	258	21-06906-06	260	21-06926-12	261	21-06957-35	263	21-06984-06	265	21-07004-12	267
21-06866-06	258	21-06906-08	260	21-06926-15	261	21-06957-40	263	21-06984-10	265	21-07004-14	267
21-06866-07	258	21-06906-10	260	21-06927-02	261	21-06957-45	263	21-06984-20	265	21-07008-01	268
21-06866-08	258	21-06906-12	260	21-06927-03	261	21-06957-50	263	21-06984-30	265	21-07008-02	268
21-06868-04	258	21-06906-14	260	21-06923-04	261	21-06957-55	263	21-06984-40	265	21-07008-03	268
21-06868-06	258	21-06910-02	260	21-06923-06	261	21-06957-60	263	21-06988-01	266	21-07008-04	268
21-06868-08	258	21-06910-03	260	21-06923-08	261	21-06957-65	263	21-06988-02	266	21-07008-10	268
21-06868-10	258	21-06910-04	260	21-06923-10	261	21-06957-70	263	21-06988-03	266	21-07008-20	268
21-06868-12	258	21-06910-05	260	21-06923-12	261	21-06957-75	263	21-06988-04	266	21-07008-30	268
21-06868-14	258	21-06910-06	260	21-06923-15	261	21-06957-80	263	21-06988-05	266	21-07012-01	268
21-06868-16	258	21-06910-07	260	21-06923-18	261	21-06957-85	263	21-06988-06	266	21-07012-02	268
21-06870-04	258	21-06910-08	260	21-06930-04	261	21-06957-90	263	21-06988-10	266	21-07012-10	268
21-06870-06	258	21-06911-02	260	21-06930-06	261	21-06957-95	263	21-06988-20	266	21-07012-20	268
21-06870-08	258	21-06911-03	260	21-06930-08	261	21-06960-06	263	21-06988-30	266	21-07014-01	268
21-06870-10	258	21-06911-04	260	21-06930-10	261	21-06960-09	263	21-06990-01	266	21-07014-02	268
21-06870-12	258	21-06911-05	260	21-06930-12	261	21-06960-13	263	21-06990-02	266	21-07014-10	268
21-06870-14	258	21-06911-06	260	21-06932-04	261	21-06960-16	263	21-06990-03	266	21-07014-20	268
21-06870-16	258	21-06911-07	260	21-06932-06	261	21-06960-19	263	21-06990-04	266	21-07017-01	268
21-06872-04	258	21-06911-08	260	21-06932-08	261	21-06960-25	263	21-06990-05	266	21-07017-02	268
21-06872-06	258	21-06914-06	260	21-06932-10	261	21-06960-32	263	21-06990-06	266	21-07018-01	269
21-06872-08	258	21-06914-09	260	21-06932-12	261	21-06961-06	263	21-06990-10	266	21-07018-02	269
21-06872-10	258	21-06914-13	260	21-06936-05	261	21-06961-09	263	21-06990-20	266	21-07018-03	269
21-06872-12	258	21-06914-16	260	21-06936-07	261	21-06961-13	263	21-06990-30	266	21-07018-10	269
21-06872-14	258	21-06914-19	260	21-06936-10	261	21-06961-16	263	21-06991-01	266	21-07020-01	269
21-06872-16	258	21-06914-25	260	21-06936-15	261	21-06961-19	263	21-06991-02	266	21-07020-02	269
21-06874-04	258	21-06914-32	260	21-06936-25	261	21-06961-25	263	21-06991-03	266	21-07020-03	269
21-06874-06	258	21-06915-06	260	21-06936-30	261	21-06961-32	263	21-06991-04	266	21-07020-04	269
21-06874-08	258	21-06915-09	260	21-06938-05	261	21-06964-06	263	21-06991-05	266	21-07020-05	269
21-06874-10	258	21-06915-13	260	21-06938-07	261	21-06964-09	263	21-06991-06	266	21-07020-06	269



**21**

Cat #	Pg #	Cat #	Pg #	Cat #	Pg #	Cat #	Pg #	Cat #	Pg #	Cat #	Pg #
21-07024-10	269	21-07120-10	275	21-07262-12	283	21-07442-21	293	21-07607-18	301	21-07758-13	309
21-07024-20	269	21-07120-15	275	21-07262-19	283	21-07446-21	293	21-07610-17	301	21-07760-18	309
21-07028-01	270	21-07120-20	275	21-07262-25	283	21-07450-16	294	21-07611-17	301	21-07761-18	309
21-07028-02	270	21-07120-25	275	21-07266-15	283	21-07450-24	294	21-07615-15	301	21-07762-13	309
21-07028-03	270	21-07124-17	275	21-07268-15	283	21-07454-17	294	21-07617-15	301	21-07764-17	309
21-07030-01	270	21-07126-19	275	21-07272-21	283	21-07454-21	294	21-07619-15	301	21-07766-17	309
21-07030-10	270	21-07130-20	275	21-07276-19	283	21-07456-17	294	21-07621-15	301	21-07768-23	310
21-07030-20	270	21-07134-16	275	21-07280-19	283	21-07456-21	294	21-07623-18	302	21-07770-31	310
21-07030-30	270	21-07138-19	275	21-07284-17	283	21-07460-18	294	21-07626-17	302	21-07772-27	310
21-07031-01	270	21-07142-29	275	21-07288-14	284	21-07460-23	294	21-07627-17	302	21-07772-30	310
21-07031-10	270	21-07146-13	275	21-07288-15	284	21-07460-25	294	21-07630-18	302	21-07774-12	310
21-07031-20	270	21-07150-15	276	21-07290-15	284	21-07460-28	294	21-07631-18	302	21-07774-15	310
21-07031-30	270	21-07154-16	276	21-07292-15	284	21-07461-23	294	21-07635-15	302	21-07774-35	310
21-07034-03	270	21-07158-01	276	21-07296-12	284	21-07461-25	294	21-07637-15	302	21-07776-39	310
21-07034-04	270	21-07158-02	276	21-07300-06	284	21-07461-28	294	21-07639-15	302	21-07776-43	310
21-07034-05	270	21-07158-03	276	21-07302-08	284	21-07464-21	294	21-07642-20	302	21-07776-45	310
21-07038-13	271	21-07158-04	276	21-07304-26	285	21-07464-27	294	21-07645-15	303	21-07776-47	310
21-07038-14	271	21-07162-06	276	21-07305-26	285	21-07464-30	294	21-07647-15	303	21-07778-00	311
21-07038-17	271	21-07162-08	276	21-07306-17	285	21-07468-19	295	21-07650-15	303	21-07778-01	311
21-07038-20	271	21-07166-29	277	21-07308-17	285	21-07470-19	295	21-07651-15	303	21-07778-02	311
21-07040-13	271	21-07168-29	277	21-07308-22	285	21-07474-17	295	21-07653-18	303	21-07778-03	311
21-07040-16	271	21-07170-28	277	21-07308-24	285	21-07478-25	295	21-07655-18	303	21-07778-04	311
21-07040-20	271	21-07174-01	277	21-07308-26	286	21-07478-26	295	21-07659-18	303	21-07778-05	311
21-07044-00	271	21-07174-02	277	21-07308-28	286	21-07478-27	295	21-07663-18	303	21-07778-06	311
21-07044-01	271	21-07174-03	277	21-07310-24	286	21-07482-15	296	21-07666-18	303	21-07778-10	311
21-07044-02	271	21-07178-22	277	21-07312-24	286	21-07482-19	296	21-07666-23	303	21-07780-15	312
21-07050-15	271	21-07182-01	278	21-07314-24	286	21-07482-24	296	21-07667-18	303	21-07784-14	312
21-07054-00	271	21-07182-02	278	21-07316-22	286	21-07482-26	296	21-07667-23	303	21-07786-21	312
21-07054-01	271	21-07182-03	278	21-07316-26	287	21-07482-28	296	21-07671-20	304	21-07788-14	312
21-07054-02	271	21-07182-04	278	21-07316-29	287	21-07486-30	296	21-07675-24	304	21-07788-14	312
21-07058-13	271	21-07182-05	278	21-07318-27	287	21-07490-22	296	21-07679-03	304	21-07792-14	313
21-07058-15	271	21-07182-06	278	21-07318-34	287	21-07490-22	296	21-07679-04	304	21-07794-16	313
21-07058-16	271	21-07182-07	278	21-07320-29	287	21-07490-30	296	21-07679-05	304	21-07798-01	313
21-07062-15	271	21-07186-01	278	21-07322-24	288	21-07494-23	296	21-07681-03	304	21-07798-02	313
21-07064-18	271	21-07186-02	278	21-07324-25	288	21-07494-26	296	21-07681-04	304	21-07798-03	313
21-07069-01	272	21-07188-01	278	21-07324-21	288	21-07498-22	296	21-07681-05	304	21-07798-04	313
21-07069-02	272	21-07188-02	278	21-07328-25	288	21-07498-25	296	21-07684-22	305	21-07798-05	313
21-07069-03	272	21-07190-01	278	21-07332-23	288	21-07498-33	296	21-07685-22	305	21-07802-18	313
21-07069-04	272	21-07190-02	278	21-07336-32	289	21-07502-26	297	21-07685-22	305	21-07802-20	313
21-07069-05	272	21-07194-04	279	21-07340-13	289	21-07506-19	297	21-07688-27	305	21-07806-16	313
21-07069-06	272	21-07194-06	279	21-07340-19	289	21-07506-23	297	21-07689-23	305	21-07806-20	313
21-07069-10	272	21-07194-08	279	21-07340-23	289	21-07506-26	297	21-07697-23	306	21-07810-16	313
21-07069-20	272	21-07194-10	279	21-07340-30	289	21-07510-33	297	21-07697-23	306	21-07814-13	314
21-07069-30	272	21-07194-13	279	21-07344-26	289	21-07510-45	297	21-07701-02	306	21-07814-18	314
21-07072-01	272	21-07194-19	279	21-07346-26	289	21-07514-33	297	21-07701-03	306	21-07818-17	314
21-07072-02	272	21-07194-25	279	21-07350-44	289	21-07514-45	297	21-07701-04	306	21-07822-15	314
21-07072-03	272	21-07198-01	280	21-07350-64	289	21-07518-14	297	21-07705-03	306	21-07826-17	314
21-07072-04	272	21-07199-02	280	21-07354-01	290	21-07522-12	297	21-07705-04	306	21-07828-17	314
21-07072-05	272	21-07201-03	280	21-07354-02	290	21-07526-13	298	21-07705-05	306	21-07830-19	314
21-07072-06	272	21-07203-04	280	21-07354-03	290	21-07526-13	298	21-07705-08	306	21-07834-15	315
21-07072-10	272	21-07206-05	280	21-07354-04	290	21-07530-20	298	21-07709-23	306	21-07836-18	315
21-07072-20	272	21-07207-14	280	21-07358-05	290	21-07534-17	298	21-07713-23	306	21-07837-16	315
21-07072-30	272	21-07209-14	280	21-07362-01	290	21-07538-17	298	21-07716-30	306	21-07840-12	316
21-07074-01	272	21-07211-20	280	21-07362-02	290	21-07542-19	298	21-07718-30	306	21-07844-15	316
21-07074-02	272	21-07214-20	281	21-07366-21	290	21-07546-18	298	21-07721-20	307	21-07848-18	316
21-07074-03	272	21-07218-08	281	21-07370-17	290	21-07546-22	298	21-07724-14	307	21-07852-18	316
21-07074-04	272	21-07218-17	281	21-07374-17	291	21-07546-22	298	21-07724-19	307	21-07856-18	316
21-07074-05	272	21-07222-10	281	21-07376-17	291	21-07550-12	298	21-07724-22	307	21-07860-22	316
21-07074-06	272	21-07222-13	281	21-07378-17	291	21-07554-18	298	21-07724-22	307	21-07864-22	316
21-07074-10	272	21-07222-19	281	21-07382-22	291	21-07554-50	298	21-07725-14	307	21-07868-16	317
21-07074-20	272	21-07222-25	281	21-07384-22	291	21-07557-17	299	21-07725-17	307	21-07868-21	317
21-07074-30	272	21-07224-10	281	21-07388-17	291	21-07559-17	299	21-07725-19	307	21-07872-01	317
21-07078-30	273	21-07224-13	281	21-07392-21	291	21-07563-17	299	21-07725-22	307	21-07872-02	317
21-07080-27	273	21-07224-19	281	21-07396-01	291	21-07567-12	299	21-07728-15	307	21-07872-03	317
21-07084-25	273	21-07228-07	282	21-07396-02	291	21-07571-14	299	21-07731-15	307	21-07872-04	317
21-07088-24	273	21-07228-15	282	21-07402-20	291	21-07575-15	300	21-07731-17	307	21-07872-05	317
21-07092-22	273	21-07228-20	282	21-07406-20	292	21-07577-15	300	21-07734-15	307	21-07876-18	317
21-07096-15	274	21-07232-18	282	21-07407-20	292	21-07580-20	300	21-07735-15	307	21-07876-27	317
21-07098-15	274	21-07236-20	282	21-07410-23	292	21-07583-14	300	21-07739-17	307	21-07880-01	317
21-07100-15	274	21-07238-20	282	21-07414-19	292	21-07583-17	300	21-07742-18	308	21-07880-02	317
21-07102-15	274	21-07240-23	282	21-07416-19	292	21-07587-18	300	21-07746-18	308	21-07880-03	317
21-07104-19	274	21-07244-15	282	21-07420-21	292	21-07591-20	300	21-07747-18	308	21-07884-10	318
21-07108-18	274	21-07248-17	282	21-07424-19	293	21-07595-16	301	21-07749-27	308	21-07884-12	318
21-07110-21	274	21-07250-16	282	21-07428-18	293	21-07595-16	301	21-07750-23	308	21-07884-20	318
21-07114-19	274	21-07254-20	282	21-07432-20	293	21-07601-19	301	21-07751-27	308	21-07884-30	318
21-07116-18	274	21-07258-16	283	21-07434-20	293	21-07603-16	301	21-07751-27	308	21-07884-40	318
21-07120-05	275	21-07262-06	283	21-07438-17	293	21-07603-19	301	21-07755-24	308	21-07884-51	318



## 21

Cat #	Pg #	Cat #	Pg #
21-07888-00	319	22-08028-11	326
21-07892-01	319	22-08028-12	326
21-07892-02	319	22-08028-13	326
21-07892-03	319	22-08030-08	326
21-07896-10	320	22-08030-09	326
21-07896-35	320	22-08030-10	326
21-07896-50	320	22-08030-11	326
21-07896-70	320	22-08030-12	326
21-07900-18	320	22-08030-13	326
21-07904-24	320		
21-07908-19	320		
21-07912-23	320		
21-07916-21	320		
21-07920-19	321		
21-07924-19	321		
21-07924-25	321		
21-07928-16	321		
21-07932-17	321		
21-07936-14	321		
21-07940-18	321		
21-07944-19	321		
21-07948-34	322		
21-07950-18	322		
21-07950-23	322		
21-07952-40	322		
21-07952-45	322		
21-07952-55	322		
21-07956-31	322		
21-07960-50	322		
21-07962-30	322		
21-07964-50	322		
21-07968-16	322		
21-07972-02	323		
21-07972-03	323		
21-07972-04	323		
21-07972-05	323		
21-07976-20	323		
21-07980-15	323		
21-07980-19	323		
21-07980-24	323		
21-07981-15	323		
21-07981-19	323		
21-07981-24	323		
21-07984-20	324		
21-07985-20	324		
21-07988-13	324		
21-07992-11	324		
21-07996-15	324		
21-07997-15	324		

## 23

Cat #	Pg #
23-08034-15	327
23-08034-16	327
23-08038-15	327
23-08038-20	327
23-08042-17	327

## 24

Cat #	Pg #
24-08046-10	328
24-08050-14	328
24-08052-14	328
24-08056-10	328
24-08060-14	328
24-08064-14	328
24-08068-18	328
24-08072-01	328
24-08072-02	328
24-08072-03	328
24-08076-01	329
24-08076-02	329
24-08076-03	329
24-08076-04	329
24-08076-05	329
24-08076-06	329
24-08080-01	329
24-08080-02	329
24-08080-03	329
24-08080-04	329
24-08084-14	329
24-08088-14	329
24-08092-01	329
24-08092-02	329
24-08094-15	329

## 22

Cat #	Pg #	Cat #	Pg #
22-08000-13	325	25-08096-15	330
22-08000-15	325	25-08100-15	330
22-08004-14	325	25-08100-19	330
22-08006-13	325	25-08100-23	330
22-08010-07	325	25-08100-25	330
22-08013-16	325	25-08104-12	330
22-08015-16	325	25-08104-14	330
22-08018-21	325	25-08108-16	330
22-08022-08	325	25-08108-20	330
22-08022-10	325	25-08108-25	330
22-08026-04	326	25-08108-30	330
22-08026-05	326	25-08112-15	330
22-08026-06	326	25-08116-15	330
22-08026-07	326	25-08120-16	330
22-08026-08	326	25-08120-20	330
22-08026-09	326	25-08124-20	330
22-08026-10	326	25-08128-15	331
22-08026-11	326	25-08128-19	331
22-08026-12	326	25-08132-18	331
22-08026-13	326	25-08136-16	331
22-08028-04	326	25-08140-20	331
22-08028-05	326	25-08144-16	331
22-08028-06	326	25-08144-20	331
22-08028-07	326	25-08148-16	331
22-08028-08	326	25-08148-18	331
22-08028-09	326	25-08148-20	331
22-08028-10	326		

## 25

Cat #	Pg #
25-08148-24	331
25-08152-16	331
25-08156-16	331
25-08156-20	331
25-08160-18	332
25-08160-20	332
25-08160-23	332
25-08164-18	332
25-08164-20	332
25-08168-20	332
25-08168-23	332
25-08172-20	332
25-08176-24	332
25-08180-24	332
25-08182-26	332
25-08186-18	333
25-08187-18	333
25-08190-21	333
25-08190-23	333
25-08191-21	333
25-08191-23	333
25-08194-25	333
25-08198-13	334
25-08198-16	334
25-08198-18	334
25-08198-21	334
25-08198-23	334
25-08199-13	334
25-08199-16	334
25-08199-18	334
25-08199-21	334
25-08199-23	334
25-08202-21	335
25-08203-21	335
25-08206-23	335
25-08210-25	335
25-08211-25	335
25-08214-25	335
25-08215-25	335
25-08219-30	336
25-08223-26	336
25-08223-28	336
25-08227-24	336
25-08231-24	336
25-08233-24	336
25-08236-13	337
25-08237-13	337
25-08240-22	337
25-08240-25	337
25-08244-28	337
25-08241-22	337
25-08241-25	337
25-08241-28	337
25-08244-22	338
25-08244-25	338
25-08244-28	338
25-08245-22	338
25-08245-25	338
25-08245-28	338
25-08248-25	339
25-08249-25	339
25-08252-15	339
25-08253-15	339
25-08253-20	339
25-08255-12	339
25-08258-15	340
25-08258-21	340
25-08258-29	340
25-08258-35	340
25-08262-30	341
25-08263-30	341
25-08266-33	342
25-08267-33	342
25-08270-33	342
25-08271-33	342
25-08274-36	343
25-08278-30	343

## 26

Cat #	Pg #	Cat #	Pg #
25-08279-30	343	26-08400-01	351
25-08282-22	344	25-08400-21	351
25-08286-20	344	25-08404-00	351
25-08290-15	344	25-08404-01	351
25-08291-15	344	25-08408-00	351
25-08294-06	344	25-08408-01	351
25-08294-08	344	25-08412-19	351
25-08294-12	344	25-08414-00	351
25-08294-15	344		
25-08298-19	344		
25-08302-17	345		
25-08306-15	345		
25-08310-01	345	26-08416-20	352
25-08310-02	345	26-08416-22	352
25-08310-03	345	26-08416-24	352
25-08210-04	345	26-08418-23	352
25-08314-01	345	26-08418-24	352
25-08314-02	345	26-08420-23	352
25-08318-22	346	26-08424-23	353
25-08322-01	346	26-08428-23	353
25-08322-02	346	26-08432-23	353
25-08322-03	346	26-08436-20	354
25-08322-04	346	26-08438-20	354
25-08326-02	346	26-08442-01	354
25-08330-00	347	26-08442-02	354
25-08330-01	347	26-08446-01	354
25-08330-02	347	26-08446-02	354
25-08330-03	347	26-08446-03	354
25-08330-04	347	26-08446-04	354
25-08334-00	347	26-08450-01	355
25-08334-01	347	26-08450-02	355
25-08334-02	347	26-08454-01	355
25-08338-28	348	26-08454-02	355
25-08338-35	348	26-08458-21	355
25-08334-35	348	26-08462-21	355
25-08338-42	348	26-08466-20	356
25-08340-28	348	26-08467-20	356
25-08340-35	348	26-08472-20	356
25-08340-42	348	26-08473-20	356
25-08342-28	348	26-08476-24	356
25-08342-35	348	26-08480-01	356
25-08342-42	348	26-08480-02	356
25-08344-28	348	26-08484-01	357
25-08344-35	348	26-08484-02	357
25-08344-42	348	26-08484-03	357
25-08348-00	348	26-08488-01	357
25-08348-33	348	26-08488-02	357
25-08348-40	348	26-08488-03	357
25-08350-33	348	26-08488-04	357
25-08350-40	348	26-08488-05	357
25-08352-33	348	26-08488-06	357
25-08352-40	348	26-08488-07	357
25-08354-33	348	26-08488-08	357
25-08354-40	348	26-08488-09	357
25-08358-33	348	26-08488-10	357
25-08358-40	348	26-08488-11	357
25-08360-33	348	26-08488-12	357
25-08360-40	348	26-08488-13	357
25-08362-33	348	26-08492-01	358
25-08362-40	348	26-08492-02	358
25-08364-30	348	26-08492-03	358
25-08364-40	348	26-08492-04	358
25-08366-21	349	26-08496-02	358
25-08368-21	349	26-08496-03	358
25-08372-30	349	26-08496-04	358
25-08376-40	349	26-08496-05	358
25-08380-01	349	26-08496-06	358
25-08380-02	349	26-08496-08	358
25-08384-11	350	26-08496-11	358
25-08384-16	350	26-08496-15	358
25-08388-10	350	26-08500-28	359
25-08388-50	350	26-08504-01	359
25-08392-10	350	26-08504-02	359
25-08392-12	350	26-08504-03	359
25-08396-00	350	26-08506-28	359
25-08396-50	350	26-08508-01	359
25-08400-00	351	26-08508-02	359
		26-08508-03	359
		26-08508-04	359
		26-08508-05	359
		26-08508-06	359
		26-08508-07	359
		26-08508-08	359
		26-08508-09	359
		26-08508-10	359
		26-08508-11	359
		26-08508-12	359
		26-08508-13	359
		26-08508-14	359
		26-08508-15	359
		26-08508-16	359
		26-08508-17	359
		26-08508-18	359
		26-08508-19	359
		26-08508-20	359
		26-08508-21	359
		26-08508-22	359
		26-08508-23	359
		26-08508-24	359
		26-08508-25	359
		26-08508-26	35



## 26

Cat #	Pg #	Cat #	Pg #	Cat #	Pg #	Cat #	Pg #	Cat #	Pg #	Cat #	Pg #
26-08556-29	363	27-08624-02	367	27-08718-18	373	27-08794-01	378	27-08816-23	380	27-08990-27	388
26-08556-30	363	27-08624-03	367	27-08722-18	374	27-08794-02	378	27-08816-27	380	27-08994-27	389
26-08560-06	364	27-08624-04	367	27-08726-19	374	27-08794-03	378	27-08816-31	380	27-08998-23	389
26-08560-07	364	27-08628-01	368	27-08730-19	374	27-08798-01	379	27-08816-35	380	27-09002-25	389
26-08560-08	364	27-08628-02	368	27-08734-00	374	27-08798-02	379	27-08816-39	380	27-09006-18	389
26-08560-09	364	27-08628-03	368	27-08734-01	374	27-08798-03	379	27-08816-43	380	27-09006-20	389
26-08560-10	364	27-08632-00	368	27-08734-02	374	27-08798-04	379	27-08820-34	381	27-09010-23	390
26-08560-11	364	27-08636-01	368	27-08736-00	374	27-08798-05	379	27-08822-28	381	27-09014-22	390
26-08560-12	364	27-08636-02	368	27-08736-01	374	27-08798-06	379	27-08824-28	381	27-09016-22	390
26-08560-13	364	27-08640-00	368	27-08736-02	374	27-08798-07	379	27-08826-28	381	27-09020-01	390
26-08560-14	364	27-08644-01	369	27-08740-00	375	27-08798-08	379	27-08830-24	381	27-09020-02	390
26-08560-15	364	27-08644-02	369	27-08740-01	375	27-08798-09	379	27-08832-24	381	27-09020-03	390
26-08560-16	364	27-08644-03	369	27-08740-02	375	27-08798-10	379	27-08836-28	381	27-09020-04	390
26-08560-17	364	27-08648-01	369	27-08742-00	375	27-08798-11	379	27-08838-28	381	27-09020-05	390
26-08560-18	364	27-08648-02	369	27-08742-01	375	27-08798-12	379	27-08842-32	382	27-09020-17	390
26-08560-19	364	27-08648-03	369	27-08742-02	375	27-08798-13	379	27-08844-32	382	27-09026-17	390
26-08560-20	364	27-08652-01	369	27-08746-01	375	27-08798-14	379	27-08846-32	382	27-09030-27	390
26-08560-21	364	27-08652-02	369	27-08746-02	375	27-08798-15	379	27-08850-32	382	27-09034-27	391
26-08560-22	364	27-08656-01	369	27-08746-03	375	27-08798-16	379	27-08852-32	382	27-09038-04	391
26-08560-23	364	27-08656-02	369	27-08750-01	376	27-08798-17	379	27-08854-32	382	27-09038-05	391
26-08560-24	364	27-08658-02	369	27-08750-02	376	27-08798-18	379	27-08858-25	382	27-09042-24	391
26-08562-06	364	27-08662-01	370	27-08750-03	376	27-08798-19	379	27-08862-28	382	27-09046-01	391
26-08562-07	364	27-08662-02	370	27-08752-01	376	27-08798-20	379	27-08866-28	383	27-09046-02	391
26-08562-08	364	27-08662-03	370	27-08752-02	376	27-08798-21	379	27-08870-01	383	27-09046-03	391
26-08562-09	364	27-08666-01	370	27-08752-03	376	27-08798-22	379	27-08870-02	383	27-09046-04	391
26-08562-10	364	27-08666-02	370	27-08752-04	376	27-08798-23	379	27-08870-03	383	27-09050-24	391
26-08562-11	364	27-08666-03	370	27-08752-05	376	27-08798-24	379	27-08872-01	383	27-09054-30	392
26-08562-12	364	27-08670-01	370	27-08754-01	376	27-08798-25	379	27-08874-01	383	27-09056-30	392
26-08562-13	364	27-08670-02	370	27-08754-02	376	27-08798-26	379	27-08874-02	383	27-09060-30	392
26-08562-14	364	27-08670-03	370	27-08754-03	376	27-08798-27	379	27-08874-03	383	27-09062-30	392
26-08562-15	364	27-08674-01	371	27-08754-04	376	27-08798-28	379	27-08876-01	384	27-09066-30	392
26-08562-16	364	27-08674-02	371	27-08754-05	376	27-08798-29	379	27-08878-01	384	27-09068-30	392
26-08562-17	364	27-08674-03	371	27-08758-01	376	27-08798-30	379	27-08878-02	384	27-09072-31	392
26-08562-18	364	27-08678-00	371	27-08758-02	376	27-08798-50	379	27-08880-01	384	27-09074-31	392
26-08562-19	364	27-08682-00	371	27-08758-03	376	27-08800-01	379	27-08880-02	384	27-09078-23	393
26-08562-20	364	27-08682-01	371	27-08760-01	376	27-08800-02	379	27-08880-03	384	27-09082-24	393
26-08562-21	364	27-08682-02	371	27-08760-02	376	27-08800-03	379	27-08882-01	384	27-09086-21	393
26-08562-22	364	27-08684-00	371	27-08760-03	376	27-08800-04	379	27-08882-02	384	27-09086-29	393
26-08562-23	364	27-08684-01	371	27-08762-01	376	27-08800-05	379	27-08886-27	385	27-09090-26	393
26-08562-24	364	27-08684-02	371	27-08762-02	376	27-08800-06	379	27-08890-17	385	27-09094-27	393
26-08566-39	364	27-08686-00	371	27-08762-03	376	27-08800-07	379	27-08894-18	385	27-09098-25	393
26-08568-35	364	27-08686-01	371	27-08766-01	376	27-08800-08	379	27-08898-25	385	27-09102-01	394
26-08572-08	365	27-08686-02	371	27-08766-02	376	27-08800-09	379	27-08902-25	385	27-09102-02	394
26-08572-11	365	27-08690-00	372	27-08766-03	376	27-08800-10	379	27-08906-25	385	27-09106-21	394
26-08571-13	365	27-08690-01	372	27-08770-01	377	27-08800-11	379	27-08910-25	385	27-09110-28	394
26-08572-16	365	27-08690-02	372	27-08770-02	377	27-08800-12	379	27-08914-28	385	27-09114-19	394
26-08572-21	365	27-08692-00	372	27-08772-01	377	27-08800-13	379	27-08918-24	386	27-09118-20	395
26-08572-26	365	27-08692-01	372	27-08772-02	377	27-08800-14	379	27-08922-26	386	27-09118-25	395
26-08572-32	365	27-08692-02	372	27-08776-01	377	27-08800-15	379	27-08926-20	386	27-09118-30	395
26-08576-00	365	27-08696-00	372	27-08776-02	377	27-08800-16	379	27-08930-26	386	27-09118-35	395
26-08580-00	365	27-08696-01	372	27-08780-20	377	27-08800-17	379	27-08934-20	386	27-09118-40	395
26-08584-20	365	27-08696-02	372	27-08780-25	377	27-08800-18	379	27-08934-24	386	27-09122-20	395
26-08588-26	365	27-08698-00	372	27-08780-30	377	27-08800-19	379	27-08936-20	386	27-09124-04	395
		27-08698-01	372	27-08780-35	377	27-08800-00	379	27-08936-24	386	27-09124-06	395
		27-08698-02	372	27-08780-40	377	27-08804-02	379	27-08938-20	386	27-09126-23	395
		27-08700-00	372	27-08782-20	377	27-08804-04	379	27-08938-24	386	27-09128-24	395
		27-08700-01	372	27-08782-25	377	27-08804-06	379	27-08942-06	387	27-09130-23	395
27-08592-01	366	27-08700-02	372	27-08782-30	377	27-08804-08	379	27-08942-08	387	27-09134-23	396
27-08592-02	366	27-08704-00	373	27-08782-35	377	27-08804-10	379	27-08942-10	387	27-09136-21	396
27-08592-03	366	27-08704-01	373	27-08782-40	377	27-08804-12	379	27-08944-06	387	27-09140-28	396
27-08596-01	366	27-08704-02	373	27-08784-20	377	27-08804-14	379	27-08944-08	387	27-09144-24	397
27-08596-02	366	27-08706-00	373	27-08784-25	377	27-08804-16	379	27-08944-10	387	27-09148-23	397
27-08596-03	366	27-08706-01	373	27-08784-30	377	27-08804-18	379	27-08944-12	387	27-09152-00	398
27-08600-00	366	27-08706-02	373	27-08784-35	377	27-08804-20	379	27-08948-08	387	27-09152-01	398
27-08604-00	366	27-08708-00	373	27-08784-40	377	27-08804-22	379	27-08948-10	387	27-09154-00	398
27-08608-01	366	27-08708-01	373	27-08786-20	377	27-08804-24	379	27-08948-12	387	27-09154-01	398
27-08608-02	366	27-08708-02	373	27-08786-25	377	27-08804-26	379	27-08952-06	387	27-09154-01	398
27-08608-03	366	27-08712-20	373	27-08786-30	377	27-08806-00	379	27-08952-08	387	27-09156-00	398
27-08612-01	366	27-08712-25	373	27-08786-35	377	27-08810-10	380	27-08952-10	387	27-09156-01	398
27-08612-02	366	27-08712-30	373	27-08786-40	377	27-08810-12	380	27-08956-16	387	27-09158-00	398
27-08612-03	366	27-08712-35	373	27-08790-00	378	27-08810-14	380	27-08960-28	387	27-09158-01	398
27-08616-01	367	27-08712-40	373	27-08790-01	378	27-08810-16	380	27-08964-24	388	27-09160-00	398
27-08616-02	367	27-08714-20	373	27-08790-02	378	27-08810-18	380	27-08968-26	388	27-09160-01	398
27-08616-03	367	27-08714-25	373	27-08790-03	378	27-08810-20	380	27-08972-21	388	27-09162-00	398
27-08620-01	367	27-08714-30	373	27-08790-04	378	27-08816-15	380	27-08974-21	388	27-09162-01	398
27-08620-02	367	27-08714-35	373	27-08790-05	378	27-08816-19	380	27-08978-32	388	27-09164-00	398
27-08620-03	367	27-08714-40	373	27-08794-00	378			27-08982-20	388	27-09164-01	398
27-08624-01	367							27-08986-25	388	27-09168-01	399

## 27

27-08592-01	366	27-08698-02	372	27-08780-40	377	27-08804-02	379	27-08938-20	386	27-09126-23	395
27-08592-02	366	27-08700-00	372	27-08782-20	377	27-08804-04	379	27-08938-24	386	27-09128-24	395
27-08592-03	366	27-08700-01	372	27-08782-25	377	27-08804-06					



**27**

Cat #	Pg #	Cat #	Pg #	Cat #	Pg #	Cat #	Pg #	Cat #	Pg #	Cat #	Pg #
27-09168-02	399	27-09222-01	402	27-09230-16	403	27-09240-27	404	29-09426-00	416	29-09546-23	424
27-09168-03	399	27-09222-02	402	27-09230-19	403	27-09240-31	404	29-09426-01	416	29-09550-07	424
27-09168-04	399	27-09222-03	402	27-09230-20	403			29-09426-02	416	29-09550-08	424
27-09168-05	399	27-09222-04	402	27-09230-21	403			29-09426-03	416	29-09550-10	424
27-09168-06	399	27-09222-05	402	27-09230-23	403	<b>28</b>		29-09426-04	416	29-09550-12	424
27-09170-01	399	27-09222-06	402	27-09230-25	403	28-09244-45	405	29-09426-05	416	29-09551-07	424
27-09170-02	399	27-09223-01	402	27-09230-30	403	28-09248-20	405	29-09430-00	416	29-09551-08	424
27-09170-03	399	27-09223-02	402	27-09230-35	403	28-09252-34	405	29-09430-01	416	29-09551-10	424
27-09170-04	399	27-09223-03	402	27-09230-40	403	28-09254-34	405	29-09430-02	416	29-09551-12	424
27-09170-05	399	27-09223-04	402	27-09231-05	403	28-09258-35	405	29-09430-03	416	29-09554-03	424
27-09170-06	399	27-09223-05	402	27-09231-06	403	28-09262-33	405	29-09434-01	417	29-09555-03	424
27-09174-01	399	27-09223-06	402	27-09231-07	403	28-09266-30	405	29-09434-02	417	29-09558-04	424
27-09174-02	399	27-09226-05	403	27-09231-08	403	28-09270-14	405	29-09436-00	417	29-09559-04	424
27-09174-03	399	27-09226-06	403	27-09231-09	403	28-09274-01	406	29-09438-01	418	29-09562-05	424
27-09174-04	399	27-09226-07	403	27-09231-11	403	28-09274-02	406	29-09438-02	418	29-09563-05	424
27-09174-05	399	27-09226-08	403	27-09231-12	403	28-09274-03	406	29-09438-03	418	29-09566-06	425
27-09177-01	400	27-09226-09	403	27-09231-14	403	28-09275-01	406	29-09442-01	418	29-09566-07	425
27-09177-02	400	27-09226-11	403	27-09231-15	403	28-09275-02	406	29-09442-02	418	29-09566-09	425
27-09177-03	400	27-09226-12	403	27-09231-16	403	28-09275-03	406	29-09442-03	418	29-09566-11	425
27-09177-04	400	27-09226-14	403	27-09231-19	403	28-09278-42	406	29-09446-01	418	29-09567-06	425
27-09177-05	400	27-09226-15	403	27-09231-20	403	28-09282-27	406	29-09446-02	418	29-09567-07	425
27-09177-06	400	27-09226-16	403	27-09231-21	403	28-09283-27	406	29-09450-01	419	29-09567-09	425
27-09180-10	400	27-09226-19	403	27-09231-23	403	28-09286-21	406	29-09450-02	419	29-09567-11	425
27-09180-12	400	27-09226-20	403	27-09231-25	403	28-09290-26	407	29-09450-03	419	29-09671-06	425
27-09180-14	400	27-09226-21	403	27-09231-30	403	28-09294-19	407	29-09454-00	419	29-09575-07	425
27-09184-30	400	27-09226-23	403	27-09231-35	403	28-09298-26	407	29-09454-01	419	29-09579-09	426
27-09188-24	400	27-09227-05	403	27-09231-40	403	28-09302-28	407	29-09454-02	419	29-09583-10	426
27-09192-24	400	27-09227-06	403	27-09232-05	403	28-09306-25	407	29-09454-03	419	29-09587-07	426
27-09196-05	401	27-09227-07	403	27-09232-06	403	28-09310-25	407	29-09258-18	420	29-09591-09	426
27-09196-07	401	27-09227-08	403	27-09232-07	403	28-09314-42	408	29-09462-19	420	29-09593-11	426
27-09196-09	401	27-09227-09	403	27-09232-08	403	28-09318-46	408	29-09466-14	420	29-09596-21	427
27-09198-05	401	27-09227-11	403	27-09232-09	403	28-09322-30	408	29-09470-16	420	29-09596-22	427
27-09198-07	401	27-09227-12	403	27-09232-11	403	28-09326-09	408	29-09474-16	420	29-09599-21	427
27-09198-09	401	27-09227-14	403	27-09232-12	403	28-09330-36	409	29-09478-25	420	29-09599-22	427
27-09202-04	401	27-09227-15	403	27-09232-14	403	28-09330-40	409	29-09478-30	420	29-09601-21	427
27-09202-06	401	27-09227-16	403	27-09232-15	403	28-09334-28	409	29-09482-30	420	29-09601-22	427
27-09202-08	401	27-09227-19	403	27-09232-16	403	28-09338-23	409	29-09486-22	421	29-09605-21	428
27-09202-10	401	27-09227-20	403	27-09232-19	403	28-09340-30	409	29-09492-24	421	29-09605-22	428
27-09202-12	401	27-09227-21	403	27-09232-20	403	28-09342-36	409	29-09490-24	421	29-09609-20	428
27-09202-14	401	27-09227-23	403	27-09232-21	403	28-09344-36	409	29-09492-24	421	29-09609-24	428
27-09206-00	401	27-09228-05	403	27-09232-23	403	28-09348-30	410	29-09496-20	421	29-09613-20	428
27-09210-01	402	27-09228-06	403	27-09232-25	403	28-09348-36	410	29-09500-20	421	29-09615-18	428
27-09210-02	402	27-09228-07	403	27-09232-30	403	28-09350-20	410	29-09504-01	421	29-09618-01	429
27-09210-03	402	27-09228-08	403	27-09232-35	403	28-09352-41	410	29-09504-02	421	29-09618-02	429
27-09210-04	402	27-09228-09	403	27-09232-40	403	28-09354-40	410	29-09508-01	421	29-09618-03	429
27-09210-05	402	27-09228-11	403	27-09233-05	403	28-09358-36	410	29-09508-02	421	29-09621-18	429
27-09210-06	402	27-09228-12	403	27-09233-06	403	28-09362-32	411	29-09512-15	422	29-09624-15	429
27-09211-01	402	27-09228-14	403	27-09233-07	403	28-09362-38	411	29-09516-01	422	29-09624-18	429
27-09211-02	402	27-09228-15	403	27-09233-08	403	28-09366-44	411	29-09516-02	422	29-09625-15	429
27-09211-03	402	27-09228-16	403	27-09233-09	403	28-09370-43	411	29-09516-03	422	29-09625-18	429
27-09211-04	402	27-09228-19	403	27-09233-11	403	28-09374-40	411	29-09516-04	422	29-09629-20	429
27-09211-05	402	27-09228-20	403	27-09233-12	403			29-09520-15	422	29-09633-24	430
27-09211-06	402	27-09228-21	403	27-09233-14	403	<b>29</b>		29-09520-24	422	29-09633-27	430
27-09214-01	402	27-09228-23	403	27-09233-15	403	29-09378-24	412	29-09524-18	423	29-09633-31	430
27-09214-02	402	27-09229-05	403	27-09233-16	403	29-09378-26	412	29-09524-21	423	29-09633-33	430
27-09214-03	402	27-09229-06	403	27-09233-19	403	29-09382-27	412	29-09526-18	423	29-09637-28	431
27-09214-04	402	27-09229-07	403	27-09233-20	403	29-09386-36	412	29-09526-21	423	29-09641-30	431
27-09214-05	402	27-09229-08	403	27-09233-21	403	29-09390-34	412	29-09530-15	423	29-09645-23	432
27-09214-06	402	27-09229-09	403	27-09233-23	403	29-09394-32	412	29-09530-19	423	29-09649-21	432
27-09215-01	402	27-09229-11	403	27-09233-25	403	29-09398-24	412	29-09530-24	423	29-09653-01	433
27-09215-02	402	27-09229-12	403	27-09233-30	403	29-09402-00	413	29-09534-16	423	29-09653-02	433
27-09215-03	402	27-09229-14	403	27-09233-35	403	29-09406-01	413	29-09534-16	423	29-09653-03	433
27-09215-04	402	27-09229-15	403	27-09233-40	403	29-09406-02	413	29-09534-24	423	29-09653-04	433
27-09215-05	402	27-09229-16	403	27-09236-16	404	29-09406-03	413	29-09534-30	423	29-09657-23	434
27-09215-06	402	27-09229-19	403	27-09236-18	404	29-09406-04	413	29-09536-16	423	29-09657-25	434
27-09218-01	402	27-09229-20	403	27-09236-19	404	29-09406-05	413	29-09536-20	423	29-09661-25	434
27-09218-02	402	27-09229-21	403	27-09236-21	404	29-09406-06	413	29-09536-24	423	29-09665-27	435
27-09218-03	402	27-09229-23	403	27-09236-23	404	29-09409-07	413	29-09536-30	423	29-09669-24	435
27-09218-04	402	27-09230-05	403	27-09236-26	404	29-09410-01	414	29-09540-16	423	29-09673-24	435
27-09218-05	402	27-09230-06	403	27-09236-28	404	29-09410-02	414	29-09540-24	423	29-09677-25	436
27-09218-06	402	27-09230-07	403	27-09237-16	404	29-09410-03	414	29-09540-30	423	29-09677-26	436
27-09219-01	402	27-09230-08	403	27-09237-18	404	29-09414-00	415	29-09543-16	423	29-09681-01	436
27-09219-02	402	27-09230-09	403	27-09237-19	404	29-09418-00	415	29-09543-20	423	29-09681-02	436
27-09219-03	402	27-09230-11	403	27-09237-21	404	29-09422-01	415	29-09543-24	423	29-09685-20	437
27-09219-04	402	27-09230-12	403	27-09237-23	404	29-09422-02	415	29-09543-30	423	29-09685-25	437
27-09219-05	402	27-09230-14	403	27-09237-26	404	29-09422-03	415			29-09685-26	437
27-09219-06	402	27-09230-15	403	27-09237-28	404						







## 30

Cat #	Pg #	Cat #	Pg #	Cat #	Pg #
30-10360-02	477	30-10452-67	484	30-10552-10	488
30-10360-03	477	30-10452-78	484	30-10556-10	488
30-10360-04	477	30-10454-00	484	30-10560-07	488
30-10360-05	477	30-10454-01	484	30-10564-09	489
30-10364-13	477	30-10454-02	484	30-10568-09	489
30-10368-13	477	30-10454-03	484	30-10572-10	489
30-10372-01	478	30-10454-12	484	30-10576-10	489
30-10372-02	478	30-10454-23	484	30-10580-11	489
30-10372-03	478	30-10454-34	484	30-10584-11	489
30-10372-04	478	30-10454-45	484	30-10586-11	489
30-10372-05	478	30-10454-56	484	30-10590-01	489
30-10372-06	478	30-10454-67	484	30-10590-02	489
30-10376-01	479	30-10454-78	484	30-10594-10	490
30-10376-02	479	30-10458-05	485	30-10596-10	490
30-10380-01	479	30-10458-07	485	30-10600-09	490
30-10380-02	479	30-10458-10	485	30-10601-09	490
30-10380-03	479	30-10462-12	485	30-10604-10	490
30-10384-01	479	30-10466-12	485	30-10605-10	490
30-10388-01	480	30-10470-13	485	30-10608-10	490
30-10388-02	480	30-10474-12	485	30-10609-10	490
30-10388-03	480	30-10478-12	485	30-10612-10	490
30-10392-01	480	30-10482-01	485	30-10613-10	490
30-10392-02	480	30-10482-02	485	30-10616-10	491
30-10396-01	480	30-10486-01	485	30-10617-10	491
30-10396-02	480	30-10486-02	485	30-10620-10	491
30-10396-03	480	30-10490-12	485	30-10621-10	491
30-10400-01	481	30-10494-13	486	30-10624-09	491
30-10400-02	481	30-10495-13	486	30-10628-05	492
30-10400-03	481	30-10498-01	486	30-10628-07	492
30-10400-04	481	30-10498-02	486	30-10628-10	492
30-10400-05	481	30-10498-03	486	30-10632-09	492
30-10400-06	481	30-10500-13	486	30-10634-09	492
30-10400-07	481	30-10502-10	486	30-10638-07	493
30-10400-08	481	30-10506-10	486	30-10640-07	493
30-10401-06	481	30-10508-10	486	30-10642-10	493
30-10404-00	482	30-10510-10	486	30-10646-08	493
30-10406-00	482	30-10514-10	486	30-10648-08	493
30-10408-01	482	30-10516-10	486	30-10650-08	493
30-10408-02	482	30-10518-10	486	30-10652-08	493
30-10408-03	482	30-10520-10	486	30-10656-05	494
30-10408-04	482	30-10524-01	487	30-10656-07	494
30-10412-15	483	30-10524-02	487	30-10656-10	494
30-10412-20	483	30-10524-03	487	30-10657-05	494
30-10416-01	483	30-10524-04	487	30-10657-07	494
30-10416-02	483	30-10524-05	487	30-10657-10	494
30-10420-16	483	30-10524-06	487	30-10660-05	494
30-10422-16	483	30-10528-01	487	30-10660-07	494
30-10426-13	483	30-10528-02	487	30-10660-10	494
30-10430-01	483	30-10528-03	487	30-10661-05	494
30-10430-02	483	30-10528-04	487	30-10661-07	494
30-10430-03	483	30-10528-05	487	30-10661-10	494
30-10434-12	484	30-10528-06	487	30-10664-08	494
30-10438-10	484	30-10528-07	487	30-10668-08	494
30-10442-01	484	30-10527-08	487	30-10669-08	494
30-10446-01	484	30-10528-09	487	30-10672-10	495
30-10446-02	484	30-10528-10	487	30-10673-10	495
30-10450-01	484	30-10528-11	487	30-10675-10	495
30-10450-02	484	30-10532-01	487	30-10678-10	495
30-10450-03	484	30-10532-02	487	30-10679-10	495
30-10450-04	484	30-10532-03	487	30-10681-10	495
30-10450-11	484	30-10532-04	487	30-10684-10	495
30-10450-22	484	30-10532-05	487	30-10685-10	495
30-10450-33	484	30-10532-06	487	30-10687-10	495
30-10450-44	484	30-10532-07	487	30-10687-02	503
30-10450-55	484	30-10532-08	487	30-10687-03	503
30-10450-66	484	30-10532-09	487	30-10688-05	503
30-10450-77	484	30-10532-10	487	30-10688-06	503
30-10450-88	484	30-10532-11	487	30-10688-07	503
30-10452-00	484	30-10532-12	487	30-10688-08	503
30-10452-01	484	30-10532-13	487	30-10688-09	503
30-10452-02	484	30-10532-14	487	30-10688-10	503
30-10452-03	484	30-10532-15	487	30-10688-11	502
30-10452-12	484	30-10536-01	487	30-10860-11	502
30-10452-23	484	30-10536-02	487	30-10864-11	502
30-10452-34	484	30-10540-10	488	30-10866-11	502
30-10452-45	484	30-10544-08	488	30-10870-09	502
30-10452-56	484	30-10548-10	488	30-10872-09	502
				30-10876-10	503
				30-10880-09	503
				30-10882-09	503
				30-10886-01	503
				30-10886-02	503
				30-10886-03	503
				30-10886-04	503
				30-10886-05	503
				30-10887-01	503
				30-10887-02	503
				30-10887-03	503
				30-10887-04	503
				30-10887-05	503
				30-10890-09	503
				30-10894-07	504
				30-10898-11	504
				30-10900-11	504
				30-10904-10	504
				30-10908-05	504
				30-10908-10	504
				30-10910-05	504
				30-10910-10	504
				30-10913-12	504
				30-10914-12	504
				30-10918-13	505
				30-10920-13	505
				30-10924-14	505

## 31

Cat #	Pg #	Cat #	Pg #	Cat #	Pg #
31-10928-00	506	31-11018-60	511	31-10932-30	506
31-10932-30	506	31-11022-00	512	31-10932-40	506
31-10932-40	506	31-11022-01	512	31-10932-50	506
31-10932-50	506	31-11022-40	512	31-10936-33	506
31-10936-33	506	31-11022-45	512	31-10940-20	506
31-10940-20	506	31-11022-50	512	31-10944-21	506
31-10944-21	506	31-11022-55	512	31-10948-00	507
31-10948-00	507	31-11022-60	512	31-10952-00	507
31-10952-00	507	31-11026-00	512	31-10956-00	507
31-10956-00	507	31-11026-01	512	31-10960-00	507
31-10960-00	507	31-11026-45	512	31-10964-00	508
31-10964-00	508	31-11026-50	512	31-10968-15	508
31-10968-15	508	31-11026-55	512	31-10968-19	508
31-10968-19	508	31-11026-60	512	31-10972-14	508
31-10972-14	508	31-11030-16	513	31-10976-45	509
31-10976-45	509	31-11032-27	513	31-10976-50	509
31-10976-50	509	31-11036-15	513	31-10976-55	509
31-10976-55	509	31-11040-16	513	31-10976-60	509
31-10978-40	509	31-11044-00	514	31-10978-40	509
31-10978-45	509	31-11044-01	514	31-10978-45	509
31-10978-50	509	31-11044-50	514	31-10978-50	509
31-10978-55	509	31-11044-60	514	31-10978-55	509
31-10978-60	509	31-11046-00	514	31-10978-60	509
31-10980-40	509	31-11046-01	514	31-10980-40	509
31-10980-45	509	31-11046-50	514	31-10980-50	509
31-10980-50	509	31-11046-60	514	31-10980-55	509
31-10980-55	509	31-11046-70	514	31-10980-60	509
31-10980-60	509	31-11050-01	515	31-10982-50	509
31-10982-50	509	31-11050-02	515	31-10982-55	509
31-10982-55	509	31-11050-03	515	31-10982-60	509
31-10982-60	509	31-11052-01	515	31-10984-35	509
31-10984-35	509	31-11052-02	515	31-10984-40	509
31-10984-40	509	31-11052-03	515	31-10984-45	509
31-10984-45	509	31-11054-01	515	31-10984-50	509
31-10984-50	509	31-11054-02	515	31-10984-55	509
31-10984-55	509	31-11054-03	515	31-10984-60	509
31-10984-60	509	31-11056-01	515	31-10984-65	509
31-10984-65	509	31-11056-02	515	31-10984-70	509
31-10984-70	509	31-11056-03	515	31-10986-35	509
31-11060-00	516	31-11060-00	516	31-10986-40	509
31-11060-01	516	31-11060-01	516	31-10986-45	509
31-11060-21	516	31-11060-21	516	31-10986-50	509
31-11060-22	516	31-11060-22	516	31-10986-55	509
31-11060-23	516	31-11060-23	516	31-10986-60	509
31-11062-00	516	31-11062-00	516	31-10986-65	509
31-11062-01	516	31-11062-01	516	31-10986-70	509
31-11064-00	516	31-11064-00	516	31-10988-35	509
31-11064-01	516	31-11064-01	516	31-10988-40	509
31-11066-00	516	31-11066-00	516	31-10988-45	509
31-11066-01	516	31-11066-01	516	31-10988-50	509
31-11070-24	517	31-11070-24	517	31-10988-55	509
31-11074-25	517	31-11074-25	517	31-10988-60	509
31-11078-15	517	31-11078-15	517	31-10988-65	509
31-11080-15	517	31-11080-15	517	31-10988-70	509
31-11082-15	517	31-11082-15	517	31-10990-50	509
31-11086-16	517	31-11086-16	517	31-10992-70	509
31-11090-01	517	31-11090-01	517	31-10994-00	510
31-11090-02	517	31-11090-02	517	31-10994-01	510
31-11090-03	517	31-11090-03	517	31-10998-00	510
31-11090-04	517	31-11090-04	517	31-10998-01	510
31-11090-05	517	31-11090-05	517	31-11002-00	510
31-11094-21					



## 31

Cat #	Pg #	Cat #	Pg #	Cat #	Pg #	Cat #	Pg #	Cat #	Pg #	Cat #	Pg #
31-11136-20	520	31-11244-03	526	31-11298-03	529	31-11358-03	533	32-11426-03	539	32-11478-02	547
31-11136-28	520	31-11244-05	526	31-11298-05	529	31-11360-01	533	32-11428-01	539	32-11478-03	547
31-11140-01	520	31-11246-03	526	31-11300-03	529	31-11360-02	533	32-11428-02	539	32-11478-04	547
31-11140-02	520	31-11246-05	526	31-11300-05	529	31-11360-03	533	32-11428-03	539	32-11478-05	547
31-11140-03	520	31-11248-03	526	31-11302-03	529	31-11362-01	533	32-11428-04	539	32-11482-01	548
31-11140-04	520	31-11248-05	526	31-11302-05	529	31-11362-02	533	32-11430-01	540	32-11482-02	548
31-11142-01	520	31-11250-03	526	31-11304-03	529	31-11362-03	533	32-11430-02	540	32-11482-03	548
31-11142-02	520	31-11250-05	526	31-11304-05	529	31-11364-01	533	32-11430-03	540	32-11482-04	548
31-11142-03	520	31-11252-00	526	31-11304-03	529	31-11364-02	533	32-11432-00	541	32-11482-05	548
31-11142-04	520	31-11252-01	526	31-11304-05	529	31-11364-03	533	32-11432-01	541	32-11482-06	548
31-11144-08	520	31-11252-02	526	31-11306-03	529	31-11366-01	533	32-11432-02	541	32-11482-07	548
31-11144-11	520	31-11252-03	526	31-11306-05	529	31-11366-02	533	32-11432-03	541	32-11482-08	548
31-11144-14	520	31-11252-04	526	31-11310-01	530	31-11366-03	533	32-11432-04	541	32-11484-01	548
31-11144-17	520	31-11252-05	526	31-11310-02	530	31-11368-01	533	32-11434-01	541	32-11484-02	548
31-11144-20	520	31-11254-00	526	31-11310-03	530	31-11368-02	533	32-11434-02	541	32-11484-03	548
31-11144-25	520	31-11254-01	526	31-11312-01	530	31-11368-03	533	32-11434-03	541	32-11484-04	548
31-11148-08	520	31-11254-02	526	31-11312-02	530	31-11370-01	533	32-11434-04	541	32-11484-05	548
31-11148-11	520	31-11254-03	526	31-11312-03	530	31-11370-02	533	32-11348-01	542	32-11484-06	548
31-11148-14	520	31-11254-04	526	31-11314-01	530	31-11370-03	533	32-11438-02	542	32-11484-07	548
31-11148-17	520	31-11254-05	526	31-11314-02	530	31-11372-01	533	32-11438-03	542	32-11484-08	548
31-11152-09	521	31-11256-00	526	31-11314-03	530	31-11372-02	533	32-11438-04	542	32-11488-01	549
31-11152-13	521	31-11256-01	526	31-11316-01	530	31-11372-03	533	32-11438-05	542	32-11488-02	549
31-11152-18	521	31-11256-02	526	31-11316-02	530	31-11374-01	533	32-11440-01	542	32-11488-03	549
31-11152-22	521	31-11256-03	526	31-11316-03	530	31-11374-02	533	32-11440-02	542	32-11488-04	549
31-11156-12	521	31-11256-04	526	31-11318-01	530	31-11374-03	533	32-11440-03	542	32-11488-05	549
31-11156-17	521	31-11256-05	526	31-11318-02	530	31-11376-01	533	32-11440-04	542	32-11488-06	549
31-11160-14	521	31-11260-03	527	31-11318-03	530	31-11376-02	533	32-11444-01	543	32-11488-07	549
31-11160-17	521	31-11260-05	527	31-11320-01	530	31-11376-03	533	32-11444-02	543	32-11488-08	549
31-11160-20	521	31-11262-03	527	31-11320-02	530	31-11378-02	534	32-11448-01	543	32-11488-09	549
31-11164-01	521	31-11262-05	527	31-11320-03	530	31-11378-03	534	32-11448-02	543	32-11488-10	549
31-11164-02	521	31-11264-03	527	31-11322-01	530	31-11378-04	534	32-11448-03	543	32-11488-11	549
31-11164-03	521	31-11264-05	527	31-11322-02	530	31-11382-16	534	32-11448-04	543	32-11488-12	549
31-11168-21	521	31-11266-03	527	31-11322-03	530	31-11386-35	535	32-11450-01	543	32-11488-13	549
31-11172-03	522	31-11266-05	527	31-11324-01	530	31-11390-65	535	32-11450-02	543	32-11488-14	549
31-11172-05	522	31-11268-03	527	31-11324-02	530	31-11392-90	535	32-11450-03	543	32-11492-01	550
31-11172-07	522	31-11268-05	527	31-11324-03	530	31-11396-01	536	32-11450-04	543	32-11492-02	550
31-11174-03	522	31-11270-03	527	31-11326-01	530	31-11396-02	536	32-11454-11	544	32-11492-03	550
31-11174-05	522	31-11270-05	527	31-11326-02	530	31-11396-03	536	32-11456-10	544	32-11492-04	550
31-11174-07	522	31-11272-03	527	31-11326-03	530	31-11396-04	536	32-11456-18	544	32-11492-05	550
31-11177-07	522	31-11272-05	527	31-11330-01	531	31-11396-05	536	32-11460-05	544	32-11492-06	550
31-11177-09	522	31-11274-03	527	31-11330-02	531	31-11398-01	536	32-11460-10	544	32-11494-01	550
31-11179-07	522	31-11274-05	527	31-11330-03	531	31-11398-02	536	32-11460-15	544	32-11494-02	550
31-11179-08	522	31-11278-03	528	31-11332-01	531	31-11398-03	536	32-11464-01	544	32-11494-03	550
31-11180-07	523	31-11278-04	528	31-11332-02	531	31-11398-04	536	32-11464-02	544	32-11494-04	550
31-11180-10	523	31-11278-05	528	31-11332-03	531	31-11398-05	536	32-11464-03	544	32-11494-05	550
31-11182-01	523	31-11278-05	528	31-11334-01	531	31-11402-01	536	32-11470-01	545	32-11494-06	550
31-11182-02	523	31-11280-03	528	31-11334-02	531	31-11402-02	536	32-11470-02	545	32-11496-01	550
31-11182-03	523	31-11280-04	528	31-11334-03	531	31-11402-03	536	32-11470-03	545	32-11496-02	550
31-11182-04	523	31-11280-05	528	31-11336-01	531	31-11402-04	536	32-11470-04	545	32-11496-03	550
31-11184-19	523	31-11282-03	528	31-11336-02	531	31-11402-05	536	32-11470-05	545	32-11496-04	550
31-11184-28	523	31-11282-04	528	31-11336-03	531	31-11404-01	536	32-11470-06	545	32-11496-05	550
31-11188-17	523	31-11282-05	528	31-11338-01	531	31-11404-02	536	32-11470-07	545	32-11496-06	550
31-11188-21	523	31-11284-03	528	31-11338-02	531	31-11404-03	536	32-11470-08	545	32-11500-01	551
31-11188-14	523	31-11284-04	528	31-11338-03	531	31-11404-04	536	32-11470-09	545	32-11500-02	551
31-11190-14	523	31-11284-05	528	31-11340-01	531	31-11404-05	536	32-11470-10	545	32-11500-03	551
31-11192-01	523	31-11286-02	528	31-11340-02	531	31-11408-01	537	32-11470-11	545	32-11500-04	551
31-11192-02	523	31-11286-03	528	31-11340-03	531	31-11408-02	537	32-11470-12	545	32-11500-05	551
31-11196-16	524	31-11286-04	528	31-11342-01	531	31-11408-03	537	32-11470-13	545	32-11502-01	551
31-11200-22	524	31-11286-05	528	31-11342-02	531	31-11408-04	537	32-11470-14	545	32-11502-02	551
31-11204-01	524	31-11286-06	528	31-11342-03	531	31-11412-16	537	32-11470-15	545	32-11504-01	551
31-11204-02	524	31-11344-01	528	31-11344-01	531			32-11474-01	546	32-11504-02	551
31-11204-03	524	31-11288-03	528	31-11344-02	531			32-11474-02	546	32-11508-01	552
31-11208-29	524	31-11288-04	528	31-11344-03	531			32-11474-03	546	32-11508-02	552
31-11212-30	524	31-11288-05	528	31-11346-01	531	32-11416-01	538	32-11474-04	546	32-11508-03	552
31-11214-30	524	31-11288-06	528	31-11346-02	531	32-11416-02	538	32-11474-05	546	32-11508-04	552
31-11218-16	525	31-11290-02	528	31-11346-03	531	32-11416-03	538	32-11474-06	546	32-11508-05	552
31-11222-15	525	31-11290-03	528	31-11350-01	532	32-11418-01	538	32-11474-07	546	32-11508-06	552
31-11226-13	525	31-11290-04	528	31-11350-02	532	32-11418-02	538	32-11474-08	546	32-11508-07	552
31-11226-18	525	31-11290-05	528	31-11350-03	532	32-11420-01	538	32-11474-09	546	32-11508-08	552
31-11230-13	525	31-11290-06	528	31-11352-01	532	32-11420-02	538	32-11474-10	546	32-11508-09	552
31-11230-18	525	31-11292-02	528	31-11352-02	532	32-11420-03	538	32-11474-11	546	32-11508-10	552
31-11234-23	525	31-11292-03	528	31-11352-03	532	32-11420-04	538	32-11474-12	546	32-11508-11	552
31-11236-20	525	31-11292-04	528	31-11354-01	532	32-11424-01	539	32-11474-13	546	32-11508-12	552
31-11240-03	526	31-11292-05	528	31-11354-02	532	32-11424-02	539	32-11474-14	546	32-11508-13	552
31-11240-05	526	31-11292-06	528	31-11354-03	532	32-11424-03	539	32-11474-15	546	32-11512-03	553
31-11242-03	526	31-11296-03	529	31-11358-01	533	32-11426-01	539	32-11474-16	546	32-11512-04	553
31-11242-05	526	31-11296-05	529	31-11358-02	533	32-11426-02	539	32-11478-01	547	32-11512-05	553

## 32

# CONTACT

24 B - Small Industrial Estate

Sialkot Pakistan 51310

Tel : +92-52-3577062

Mob : +92-312-5216716

Email : [info@medicalsteelind.com](mailto:info@medicalsteelind.com)

[sales@medicalsteelind.com](mailto:sales@medicalsteelind.com)

[marketing@medicalsteelind.com](mailto:marketing@medicalsteelind.com)